



ProMark™ 800

powered by
ashtech



Reference Manual



Copyright Notice

Copyright 2011 Ashtech LLC. All rights reserved.
P/N 631668 A, October 2011

Trademarks

All product and brand names mentioned in this publication are trademarks of their respective holders.

FCC Notice

ProMark 800 Receiver complies with the limits for a Class B digital device, pursuant to the Part 15 of the FCC rules when it is used in Portable Mode. See Note below related to Class B device.

Class B digital devices NOTE: This equipment has been tested and found to comply with the limits for a Class B digital device, pursuant to Part 15 of the FCC Rules. These limits are designed to provide reasonable protection against harmful interference in a residential installation. This equipment generates, uses, and can radiate radio frequency energy and, if not installed and used in accordance with the instructions, may cause harmful interference to radio communications. However, there is no guarantee that interference will not occur in a particular installation. If this equipment does cause harmful interference to radio or television reception, which can be determined by turning the equipment off and on, the user is encouraged to try and correct the interference by one or more of the following measures:

- Reorient or locate the receiving antenna.
- Increase the separation between the equipment and receiver.
- Connect the equipment into an outlet on a circuit different from that to which the receiver is connected.
- Consult the dealer or an experienced radio/TV technician for help.

When ProMark 800 is used with an external power supply or connected to an external device using the USB port, it complies with the limits for a Class A digital device, pursuant to the Part 15 of the FCC rules. See Note below related to Class A device.

Class A digital devices NOTE: This equipment has been tested and found to comply with the limits for a Class A digital device, pursuant to Part 15 of the FCC Rules. These limits are designed to provide reasonable protection against harmful interference when the equipment is operated in a commercial environment. This equipment generates, uses, and can radiate radio frequency energy and, if not installed and used in accordance with the instruction manual, may cause harmful interference to radio communications. Operation of this equipment in a residential area is likely to cause harmful interference in which case the user will be required to correct the interference at his own expense.

Remark: Any changes or modifications not expressly approved by Ashtech could void the right for user to operate the equipment.

RF Safety Exposure To Radio Frequency Energy (SAR)

Radio transmitting devices radiate Radio Frequency (RF) energy during its operation. RF energy can be absorbed into the human body and potentially can cause adverse health effects if excessive levels are absorbed. The unit of measurement for human exposure to RF energy is "Specific Absorption Rate" (SAR).

The Federal Communications Commission (FCC), Industrie Canada (IC), and other agencies around the world have established limits that incorporate a substantial safety margin designed to assure the safety of all persons using this equipment. In order to certify this unit for sale in the US, Canada and Europe this unit has been tested for RF exposure compliance at a qualified test laboratory and found to comply with the regulations regarding exposure to RF Energy. SAR was measured with the unit (GSM Module) transmitting at its maximum certified RF power. Often, however, during normal operation the unit (GSM Module) will transmit much less than maximum power. Transmit power is controlled automatically and, in general is reduced as you get closer to a cellular base station. This reduction in transmit power will result in a lower RF energy exposure and resulting SAR value.

FCC and CE UHF Safety Statement

The different versions of the UHF Transmitters are FCC and CE compliant.

In order to comply with FCC and CE RF exposure safety guidelines as body-worn, normal use of unit, the following must be followed:

A distance of AT LEAST 10 feet (3 m) of separation between the users body and the unit (UHF Transmitter). This distance has been defined taken into account the FCC and CE Requirements and the worst output power configuration.

Do NOT use the device in a manner such that it is in direct contact with the body (e.g. on the lap). Such use will likely exceed FCC RF safety exposure limits. See www.fcc.gov/oet/rfsafety/ for more information on RF exposure safety.

To comply with CE and FCC electrical safety regulations, ProMark 800 should only be powered from a 6 to 28 V DC external source, with 20 W power limitation, or the recommended battery (P/N 111374). The battery should be charged only with the supplied battery charger (P/N 802064).

Ashtech Products - Limited Warranty (North, Central and South America)

Ashtech warrants their GPS receivers and hardware accessories to be free of defects in material and workmanship and will conform to our published specifications for the product for a period of one year from the date of original purchase. THIS WARRANTY APPLIES ONLY TO THE ORIGINAL PURCHASER OF THIS PRODUCT.

In the event of a defect, Ashtech will, at its option, repair or replace the hardware product with no charge to the purchaser for parts or labor. The repaired or replaced product will be warranted for 90 days from the date of return shipment, or for the balance of the original warranty, whichever is longer. Ashtech warrants that software products or software included in hardware products will be free from defects in the media for a period of 30 days from the date of shipment and will substantially conform to the then-current user documentation provided with the software (including updates thereto). Ashtech's sole obligation shall be the correction or replacement of the media or the software so that it will substantially conform to the then-current user documentation. Ashtech does not warrant the software will meet purchaser's requirements or that its operation will be uninterrupted, error-free or virus-free. Purchaser assumes the entire risk of using the software.

PURCHASER'S EXCLUSIVE REMEDY UNDER THIS WRITTEN WARRANTY OR ANY IMPLIED WARRANTY SHALL BE LIMITED TO THE REPAIR OR REPLACEMENT, AT ASHTECH'S OPTION, OF ANY DEFECTIVE PART OF THE RECEIVER OR ACCESSORIES WHICH ARE COVERED BY THIS WARRANTY. REPAIRS UNDER THIS WARRANTY SHALL ONLY BE MADE AT AN AUTHORIZED ASHTECH SERVICE CENTER. ANY REPAIRS BY A SERVICE CENTER NOT AUTHORIZED BY ASHTECH WILL VOID THIS WARRANTY.

To obtain warranty service the purchaser must obtain a Return Materials Authorization (RMA) number prior to shipping by calling 1-800-229-2400 (North America) or 1-408-572-1134 (International) and leaving a voice mail at option 3, or by submitting a repair request on-line at: <http://ashtech.com> (fill out the RMA request from under the Support tab). The purchaser must return the product postpaid with a copy of the original sales receipt to the address provided by Ashtech with the RMA number. Purchaser's return address and the RMA number must be clearly printed on the outside of the package.

Ashtech reserves the right to refuse to provide service free-of-charge if the sales receipt is not provided or if the information contained in it is incomplete or illegible or if the serial number is altered or removed. Ashtech will not be responsible for any losses or damage to the product incurred while the product is in transit or is being shipped for repair. Insurance is recommended. Ashtech suggests using a trackable shipping method such as UPS or FedEx when returning a product for service.

EXCEPT AS SET FORTH IN THIS LIMITED WARRANTY, ALL OTHER EXPRESSED OR IMPLIED WARRANTIES, INCLUDING THOSE OF FITNESS FOR ANY PARTICULAR PURPOSE, MERCHANTABILITY OR NON-INFRINGEMENT, ARE HEREBY DISCLAIMED AND IF APPLICABLE, IMPLIED WARRANTIES UNDER ARTICLE 35 OF THE UNITED NATIONS CONVENTION ON CONTRACTS FOR THE INTERNATIONAL SALE OF GOODS. Some national, state, or local laws do not allow limitations on implied warranty or how long an implied warranty lasts, so the above limitation may not apply to you.

The following are excluded from the warranty coverage: (1) periodic maintenance and repair or replacement of parts due to normal wear and tear; (2) batteries and finishes; (3) installations or defects resulting from installation; (4) any damage caused by (i) shipping, misuse, abuse, negligence, tampering, or improper use; (ii) disasters such as fire, flood, wind, and lightning; (iii) unauthorized attachments or modification; (5) service performed or attempted by anyone other than an authorized Ashtech Service Center; (6) any product, components or parts not manufactured by Ashtech; (7) that the receiver will be free from any claim for infringement of any patent, trademark, copyright or other proprietary right, including trade secrets; and (8) any damage due to accident, resulting from inaccurate satellite transmissions. Inaccurate transmissions can occur due to changes in the position, health or geometry of a satellite or modifications to the receiver that may be required due to any change in the GPS. (Note: Ashtech GPS receivers use GPS or GPS+GLONASS to obtain position, velocity and time information. GPS is operated by the U.S. Government and GLONASS is the Global Navigation Satellite System of the Russian Federation, which are solely responsible for the accuracy and maintenance of their systems. Certain conditions can cause inaccuracies which could require

modifications to the receiver. Examples of such conditions include but are not limited to changes in the GPS or GLONASS transmission.) Opening, dismantling or repairing of this product by anyone other than an authorized Ashtech Service Center will void this warranty.

ASHTECH SHALL NOT BE LIABLE TO PURCHASER OR ANY OTHER PERSON FOR ANY INCIDENTAL OR CONSEQUENTIAL DAMAGES WHATSOEVER, INCLUDING BUT NOT LIMITED TO LOST PROFITS, DAMAGES RESULTING FROM DELAY OR LOSS OF USE, LOSS OF OR DAMAGES ARISING OUT OF BREACH OF THIS WARRANTY OR ANY IMPLIED WARRANTY EVEN THOUGH CAUSED BY NEGLIGENCE OR OTHER FAULT OF ASHTECH OR NEGLIGENCE USAGE OF THE PRODUCT. IN NO EVENT WILL ASHTECH BE RESPONSIBLE FOR SUCH DAMAGES, EVEN IF ASHTECH HAS BEEN ADVISED OF THE POSSIBILITY OF SUCH DAMAGES.

This written warranty is the complete, final and exclusive agreement between Ashtech and the purchaser with respect to the quality of performance of the goods and any and all warranties and representations. This warranty sets forth all of Ashtech's responsibilities regarding this product. This limited warranty is governed by the laws of the State of California, without reference to its conflict of law provisions or the U.N. Convention on Contracts for the International Sale of Goods, and shall benefit Ashtech, its successors and assigns.

This warranty gives the purchaser specific rights. The purchaser may have other rights which vary from locality to locality (including Directive 1999/44/EC in the EC Member States) and certain limitations contained in this warranty, including the exclusion or limitation of incidental or consequential damages may not apply.

For further information concerning this limited warranty, please call or write:

Ashtech - ZAC La Fleuriaye - BP 433 - 44474 Carquefou Cedex - France Phone: +33 (0)2 28 09 38 00, Fax: +33 (0)2 28 09 39 39.

Ashtech Products Limited Warranty (Europe, Middle East, Africa)

All Ashtech global positioning system (GPS) receivers are navigation aids, and are not intended to replace other methods of navigation. Purchaser is advised to perform careful position charting and use good judgment. READ THE USER GUIDE CAREFULLY BEFORE USING THE PRODUCT.

1. ASHTECH WARRANTY

Ashtech warrants their GPS receivers and hardware accessories to be free of defects in material and workmanship and will conform to our published specifications for the product for a period of one year from the date of original purchase or such longer period as required by law. THIS WARRANTY APPLIES ONLY TO THE ORIGINAL PURCHASER OF THIS PRODUCT.

In the event of a defect, Ashtech will, at its option, repair or replace the hardware product with no charge to the purchaser for parts or labor. The repaired or replaced product will be warranted for 90 days from the date of return shipment, or for the balance of the original warranty, whichever is longer. Ashtech warrants that software products or software included in hardware products will be free from defects in the media for a period of 30 days from the date of ship-

ment and will substantially conform to the then-current user documentation provided with the software (including updates thereto). Ashtech's sole obligation shall be the correction or replacement of the media or the software so that it will substantially conform to the then-current user documentation. Ashtech does not warrant the software will meet purchaser's requirements or that its operation will be uninterrupted, error-free or virus-free. Purchaser assumes the entire risk of using the software.

2. PURCHASER'S REMEDY

PURCHASER'S EXCLUSIVE REMEDY UNDER THIS WRITTEN WARRANTY OR ANY IMPLIED WARRANTY SHALL BE LIMITED TO THE REPAIR OR REPLACEMENT, AT ASHTECH'S OPTION, OF ANY DEFECTIVE PART OF THE RECEIVER OR ACCESSORIES WHICH ARE COVERED BY THIS WARRANTY. REPAIRS UNDER THIS WARRANTY SHALL ONLY BE MADE AT AN AUTHORIZED ASHTECH SERVICE CENTER. ANY REPAIRS BY A SERVICE CENTER NOT AUTHORIZED BY ASHTECH WILL VOID THIS WARRANTY.

3. PURCHASER'S DUTIES

To obtain service, contact and return the product with a copy of the original sales receipt to the dealer from whom you purchased the product.

Ashtech reserves the right to refuse to provide service free-of-charge if the sales receipt is not provided or if the information contained in it is incomplete or illegible or if the serial number is altered or removed. Ashtech will not be responsible for any losses or damage to the product incurred while the product is in transit or is being shipped for repair. Insurance is recommended. Ashtech suggests using a trackable shipping method such as UPS or FedEx when returning a product for service.

4. LIMITATION OF IMPLIED WARRANTIES

EXCEPT AS SET FORTH IN ITEM 1 ABOVE, ALL OTHER EXPRESSED OR IMPLIED WARRANTIES, INCLUDING THOSE OF FITNESS FOR ANY PARTICULAR PURPOSE OR MERCHANTABILITY, ARE HEREBY DISCLAIMED AND IF APPLICABLE, IMPLIED WARRANTIES UNDER ARTICLE 35 OF THE UNITED NATIONS CONVENTION ON CONTRACTS FOR THE INTERNATIONAL SALE OF GOODS.

Some national, state, or local laws do not allow limitations on implied warranty or how long an implied warranty lasts, so the above limitation may not apply to you.

5. EXCLUSIONS

The following are excluded from the warranty coverage:

- (1) periodic maintenance and repair or replacement of parts due to normal wear and tear;
- (2) batteries;
- (3) finishes;
- (4) installations or defects resulting from installation;
- (5) any damage caused by (i) shipping, misuse, abuse, negligence, tampering, or improper use; (ii) disasters such as fire, flood, wind, and lightning; (iii) unauthorized attachments or modification;
- (6) service performed or attempted by anyone other than an authorized Ashtech Service Center;
- (7) any product, components or parts not manufactured by Ashtech,

(8) that the receiver will be free from any claim for infringement of any patent, trademark, copyright or other proprietary right, including trade secrets

(9) any damage due to accident, resulting from inaccurate satellite transmissions. Inaccurate transmissions can occur due to changes in the position, health or geometry of a satellite or modifications to the receiver that may be required due to any change in the GPS. (Note: Ashtech GPS receivers use GPS or GPS+GLONASS to obtain position, velocity and time information. GPS is operated by the U.S. Government and GLONASS is the Global Navigation Satellite System of the Russian Federation, which are solely responsible for the accuracy and maintenance of their systems. Certain conditions can cause inaccuracies which could require modifications to the receiver. Examples of such conditions include but are not limited to changes in the GPS or GLONASS transmission.)

Opening, dismantling or repairing of this product by anyone other than an authorized Ashtech Service Center will void this warranty.

6. EXCLUSION OF INCIDENTAL OR CONSEQUENTIAL DAMAGES

ASHTECH SHALL NOT BE LIABLE TO PURCHASER OR ANY OTHER PERSON FOR ANY INDIRECT, INCIDENTAL OR CONSEQUENTIAL DAMAGES WHATSOEVER, INCLUDING BUT NOT LIMITED TO LOST PROFITS, DAMAGES RESULTING FROM DELAY OR LOSS OF USE, LOSS OF OR DAMAGES ARISING OUT OF BREACH OF THIS WARRANTY OR ANY IMPLIED WARRANTY EVEN THOUGH CAUSED BY NEGLIGENCE OR OTHER FAULT OF ASHTECH OR NEGLIGENT USAGE OF THE PRODUCT. IN NO EVENT WILL ASHTECH BE RESPONSIBLE FOR SUCH DAMAGES, EVEN IF ASHTECH HAS BEEN ADVISED OF THE POSSIBILITY OF SUCH DAMAGES.

Some national, state, or local laws do not allow the exclusion or limitation of incidental or consequential damages, so the above limitation or exclusion may not apply to you.

7. COMPLETE AGREEMENT

This written warranty is the complete, final and exclusive agreement between Ashtech and the purchaser with respect to the quality of performance of the goods and any and all warranties and representations. THIS WARRANTY SETS FORTH ALL OF ASHTECH'S RESPONSIBILITIES REGARDING THIS PRODUCT.

THIS WARRANTY GIVES YOU SPECIFIC RIGHTS. YOU MAY HAVE OTHER RIGHTS WHICH VARY FROM LOCALITY TO LOCALITY (including Directive 1999/44/EC in the EC Member States) AND CERTAIN LIMITATIONS CONTAINED IN THIS WARRANTY MAY NOT APPLY TO YOU.

8. CHOICE OF LAW.

This limited warranty is governed by the laws of France, without reference to its conflict of law provisions or the U.N. Convention on Contracts for the International Sale of Goods, and shall benefit Ashtech, its successors and assigns.

THIS WARRANTY DOES NOT AFFECT THE CUSTOMER'S STATUTORY RIGHTS UNDER APPLICABLE LAWS IN FORCE IN THEIR LOCALITY, NOR THE CUSTOMER'S RIGHTS AGAINST THE DEALER ARISING FROM THEIR SALES/PURCHASE CONTRACT (such as the guarantees in France for latent

defects in accordance with Article 1641 et seq of the French Civil Code).

For further information concerning this limited warranty, please call or write:

Ashtech - ZAC La Fleuriaye - BP 433 - 44474 Carquefou Cedex - France.

Phone: +33 (0)2 28 09 38 00, Fax: +33 (0)2 28 09 39 39.

NOTICE:

The FCC (Federal Communications Commission) requests that equipment manufacturers take every step to increase user awareness about the responsibilities inherent in being an FCC licensee on shared channels.

Users are indeed requested to obtain a FCC license before operating their RTK equipment on the US territory. Once a license has been granted, users should observe all the FCC regulations (see <http://wireless.fcc.gov/>). Licensees are encouraged to avoid any use of voice frequencies in the 450-470 MHz band.

How To Use this Documentation

Please read this section to understand the organization of the present manual. This will help you navigate more easily through the pages and find more quickly the information you are looking for.

Chapter 1 provides a full description of the ProMark 800 (front panel display screens, connectors, accessories, batteries, etc.). Compared to the Getting Started Guide, this chapter provides four additional sections: Using the Carrying Case, Specifications, Firmware Options and Port Pinouts.

Chapter 2 explains how to set up the equipment for RTK surveys.

Chapter 3 gives information on how to set up ProMark 800 for post-processed surveys and how to collect raw data with a standalone ProMark 800.

Chapters 4 and 5 give in-depth information on GNSS surveying techniques, seen from both the theoretical and practical point of view. Key terms and expressions are also introduced at the beginning of each of the sections. The purpose is that you not only become familiar with these techniques, but also make them yours.

Note that these chapters refer to GNSS equipment in general, including Ashtech equipment, and so are not specific to the ProMark 800 only. If in doubt with what the ProMark 800 really does in such or such circumstance, please refer to the *Specifications* section in chapter 1 of this manual.

Chapter 4 gives information on surveying techniques for both real-time and post-processed surveys. It includes separate sections on such particular topics as base position, initialization, antenna heights, virtual antennas, accuracy, elevation vs. height and localization.

Chapter 5 deals more specifically with RTK surveying, introducing hardware means and data formats that exist today to implement the data link. (Through the data link, the rover receives the data it needs to operate in this mode.) Chapter 5 also introduces the two position output modes available in RTK and helps surveyors choose the one that's best for their applications.

Chapter 6 is a collection of first-level maintenance instructions you may have to refer to, should you encounter problems with your equipment. The list of possible alarms (and remedies) is also provided in this chapter.

Chapter 7 is an appendix gathering various procedures and memo pages (file naming conventions, button combinations, etc.).

As a supplement to the ProMark 800 Reference Manual, four additional appendices are provided describing all serial commands and data outputs pertaining to the receiver.

Appendix A is an introduction to the \$PASH proprietary commands. It introduces the two categories of commands, tells you how to apply them, describes the conventions used in their description and provides an alphabetical list, combining set and query commands in a single table.

Appendix B provides a full description of all the set commands.

Appendix C provides a full description of all the query commands.

Appendix D provides a full description of all the output messages.

Table of Contents

Chapter 1. Introduction	1
What is ProMark 800?	1
System Components Overview.....	1
Using the ProMark 800 Carrying Case	4
Equipment Description & Basic Functions	5
Display Screens	9
Charging Batteries Before Use	15
Specifications.....	17
Firmware Options	21
U-Link Radios.....	22
Port Pinouts.....	25
Chapter 2. RTK Surveying Preliminary Steps	29
Introduction.....	29
RTK Base Setup.....	30
RTK Rover Setup.....	33
Chapter 3. Post-Processed Surveying	35
Introduction.....	35
System Setup	36
Starting/Stopping Raw Data Logging	36
Downloading Raw Data	37
Chapter 4. Precise Surveying - Field Applications & Concepts	39
Introduction to Precise Surveying.....	39
RTK Surveying	40
Post-Processed Surveying.....	46
Choosing a Location for the Base	52
Initialization	55
GNSS Antennas and Antenna Heights	62
Using a Virtual Antenna	67
Ellipsoidal Height and Elevation	69
General Considerations Regarding Accuracy	72
Localization	75
Chapter 5. RTK Implementation	79
Data Link	79
RTK Correction Data Formats	89
RTK Position Output.....	91

Chapter 6. Troubleshooting	99
List of Alarms	99
Receiver is Not Tracking Satellites	103
Receiver is Not Logging Data	105
Radio Data Link Fails to Provide Base Corrections to Rover.....	106
Data Link Okay but No Fixed Position Computed	109
Rover is Computing Positions with High Uncertainties.....	111
Logging Data for RTK Troubleshooting Purposes -	
Reporting a Problem to Ashtech Tech Support	114
Chapter 7. Miscellaneous	117
ATOM File Naming Conventions.....	117
Reverting to V1 for All ATOM Messages Generated	
by the Receiver	117
Time-tagged RTK vs. FAST RTK Position Output	118
Special Button Combinations Summary	118
Reset Procedure	119
Using a USB key to Save/Upload Receiver Configurations	
or Copy User Data	119
Asking a Rover to Use the Same Local Coordinate System	
as the Base.....	122
Firmware Upgrade Procedure.....	123
Enabling a Firmware Option	124
Configuring Serial Port A	125
Installing a SIM Card	125
Changing the Radio Module or Using One for the First Time	126
Direct IP Connection To Your Own Base Through	
GPRS Modem and RTDS Software	127
Using a Background Map In FAST Survey	130
Default Settings	136

ProMark 800 Serial Commands & Data Outputs Supplement

Appendix A. Using Serial Commands	143
Introduction to Serial Commands	143
Applying Commands Through Bluetooth or a Serial Port	144
Running Serial Commands from a USB Key	146
List of Commands	147
Appendix B. Set Command Library	153
AGB: Enabling/Disabling GLONASS Bias Adjustments	153
ANH: Antenna Height	154
ANP,PCO & ANP,EDx: Creating/Editing Antenna Definitions	154
ANP,DEL: Delete User-Defined Antenna	155
ANP,OUT: Defining a Virtual Antenna.....	156
ANP,REF: Naming the Antenna Used at the Base.....	157
ANR: Antenna Reduction Mode	158
ANT: Antenna Height.....	159
ATL: Debug Data Recording	162
ATM: Enabling/Disabling ATOM Messages	163
ATM,ALL: Disabling All ATOM Messages	165
ATM,PER: Setting Unique Output Rate for all ATOM Messages...	166
ATM,VER: Setting the Version of ATOM Messages	167
BAS: Differential Data Type.....	167
BEEP: Beeper Setup.....	169
BRD: Enabling/Disabling the RTC Bridge Function	169
BTH,NAME: Bluetooth Device Name.....	173
BTH,PIN: Bluetooth Device Pin Code	173
CFG: GNSS Tracking Configuration	174
CMD,LOD: Running a List of \$PASH Commands	176
CMD,WTI: Inserting Wait Times	177
CMR,TYP: CMR Message Type and Rate.....	178
CPD,AFP: Setting the Confidence Level of Ambiguity Fixing	179
CPD,FST: RTK Output Mode	180
CPD,MOD: Base/Rover/Backup Mode	180
CPD,NET: Network Corrections.....	182
CPD,REM: Differential Data Port.....	183
CPD,RST: RTK Process Reset.....	184
CPD,VRS: VRS Assumption Mode	185
CTS: Handshaking.....	186
DBN,TYP: DBEN Message Type & Output Rate	186
DIP: Server Connection.....	187
DIP,OFF: Terminating Direct IP Connection	188
DIP,ON: Establishing the Programmed Direct IP Connection.....	189
DIP,PAR: Setting Direct IP Parameters.....	189
DRI: Raw Data Recording Rate	190
DSY: Daisy Chain	191
DYN: Receiver Dynamics.....	192

ELM: Setting the Elevation Mask for Raw Data Output	193
FIL,D: Deleting Files.....	194
FIL,DEL: Deleting Files and Directories	195
GAL: Galileo Tracking	196
GLO: GLONASS Tracking	197
GPS: GPS Tracking.....	198
INI: Receiver Initialization.....	200
LCS: Enabling/Disabling Use of Local Coordinate System	201
LOG,DEL: Deleting Log Files	202
LOG,PAR: Log File Settings.....	203
LTZ: Time Zone.....	203
MDM,INI: Initializing the Modem.....	204
MDM,OFF: Powering Off the Internal Modem	205
MDM,ON: Powering On the Internal Modem	205
MDM,PAR: Setting the Modem Parameters	206
MDP: Setting Port A to RS232 or RS422	207
MEM: Selecting Memory Device Used	208
MWD: Setting the Modem Timeout.....	209
NME: Enabling/Disabling NMEA Messages.....	209
NME,ALL: Disabling All NMEA and NMEA-Like Messages	211
NME,PER: Setting Unique Output Rate for all NMEA Messages ..	212
NPT: Tagging SBAS Differential Positions in NMEA & NMEA-Like Messages	213
NTR,LOD: Loading the NTRIP Caster Source Table.....	214
NTR,MTP: Connecting Receiver to NTRIP Caster Mount Point	215
NTR,PAR: NTRIP Settings.....	216
OCC: Writing Occupation Data to Raw Data File	217
OPTION: Receiver Firmware Options	218
PAR,LOD: Configuring the Receiver From a PAR File	219
PAR,SAV: Saving the Receiver Configuration To a PAR File	220
PEM: Setting the Position Elevation Mask.....	222
POP: Setting Internal Update Rate for Measurements and PVT ...	222
POS: Setting the Antenna Position	223
PPS: Setting PPS Pulse Properties.....	224
PRT: Setting Baud Rates.....	225
PWR,OFF: Powering Off the Receiver	226
PWR,PAR: Power Management	226
RAW: Enabling/Disabling Raw Data Messages in Legacy Ashtech Format	227
RAW,ALL: Disabling All Raw Data Messages	229
RAW,PER: Setting Unique Output Rate for Raw Data.....	230
RCP,GBx: GLONASS Carrier Phase Biases for User-Defined Receiver	231
RCP,DEL: Deleting User-Defined Receiver Name.....	232
RCP,REF: Naming Reference Receiver	233
RDP,OFF: Powering Off the Internal Radio.....	234
RDP,ON: Powering On the Internal Radio	234

RDP,PAR: Setting the Radio.....	235
RDP,TYP: Defining the Type of Radio and the Receiver Port Used	239
REC: Enable/Disable, Start/Stop Raw Data Recording	240
RNX,TYP: ATOM RNX Differential Message.....	242
RST: Default Settings	243
RTC,MSG: Defining a User Message.....	244
RTC,TYP: RTCM Message Type.....	245
SBA: Enabling/Disabling SBAS Tracking.....	247
SIT: Defining a Site Name.....	247
SNM: Signal-To-Noise Ratio Mask.....	248
SOM: Masking Signal Observations	248
SOM,CTT: Cumulative Tracking Time Mask.....	250
SOM,NAV: Navigation Data Mask.....	251
SOM,SNR: Signal-to-Noise Ratio Mask.....	252
SOM,WRN: Channel Warnings Mask.....	254
STI: Defining a Station ID	255
SVM: Setting the Maximum Number of Observations in the PVT ..	256
UDP: User-Defined Dynamic Model Parameters.....	257
UNT: Distance Unit Used on Display Screen	257
UTS: Synchronizing Onto GPS Time	258
WAK: Acknowledging Alarms	259
ZDA: Setting Date & Time	260
Appendix C. Query Command Library	261
AGB: Reading GLONASS Bias Setting	261
ALM: Almanac Message	262
ANH: Antenna Height	263
ANP: Antenna Parameters.....	264
ANP,OUT: Virtual Antenna	265
ANP,OWN: Local Antenna Used.....	265
ANP,RCV: Antenna Name and Offsets of Received Base.....	266
ANP,REF: Antenna Used at the Base	267
ANR: Antenna Reduction Mode	267
ANT: Antenna Height.....	268
ATL: Debug Data Recording	269
ATM: ATOM Data Parameters	271
ATO: ATOM Message Output Settings.....	272
BAS: Differential Data Type.....	273
BEEP: Beeper State	275
BRD: RTC Bridge	276
BTH: Bluetooth Settings	276
CFG: GNSS Tracking Configuration	277
CMR,MSI: CMR Message Status	278
CPD,AFP: Ambiguity Fixing Parameter.....	279
CPD,ANT: Base Antenna Height.....	280
CPD,FST: Fast RTK Output Mode	281
CPD,MOD: Base/Rover/Backup Mode	281

CPD,NET: RTK Network Operation Mode	282
CPD,POS: Base Position	283
CPD,REM: Differential Data Port.....	285
CPD,VRS: VRS Assumption Mode	286
CRT: Cartesian Coordinates of Position	287
CTS: Handshaking.....	288
DBN,MSI: DBEN Message Status.....	289
DCR: Cartesian Coordinates of Baseline.....	290
DDS: Differential Decoder Status	291
DIP: Direct IP Parameters	292
DPO: Delta Position	294
DRI: Raw Data Recording Rate	295
DSY: Daisy Chain Status	296
DTM: Datum Reference.....	297
DYN: Receiver Dynamics.....	299
ELM: Elevation Mask	300
FIL,CUR: Information On G-File Being Recorded	300
FIL,LST: Listing Files in Receiver Memory or USB Key.....	301
FLS: List of Raw Data Files	302
GAL: GALILEO Tracking Status.....	303
GGA: GNSS Position Message.....	304
GLL: Geographic Position - Latitude/Longitude.....	305
GLO: GLONASS Tracking Status	307
GNS: GNSS Fix Data	307
GPS: GPS Tracking Status.....	309
GRS: GNSS Range Residuals.....	311
GSA: GNSS DOP and Active Satellites.....	312
GST: GNSS Pseudo-Range Error Statistics	314
GSV: GNSS Satellites in View	316
LCS: Local Coordinate System Status	317
LOG: Editing a Log File.....	319
LOG,LST: Listing Log Files.....	320
LOG,PAR: Log File Settings.....	320
MDM: Modem Status and Parameters.....	321
MDM,LVL: Modem Signal Level	323
MDM,STS: Modem Status	323
MDP: Port A Setting	324
MEM: Selected Memory Device.....	325
MWD: Modem Watchdog Timeout	325
NMO: NMEA Message Output Settings	326
NPT: Tagging of SBAS Differential Positions in NMEA & NMEA-Like Messages	327
NTR: NTRIP Settings.....	328
NTR,MTP: Connection to Mount Point.....	329
NTR,TBL: Source Table	330
OCC: Occupation State and Parameters.....	332
OPTION: Installed Receiver Firmware Options.....	333

PAR: Receiver Parameters.....	334
PEM: Position Elevation Mask	336
POP: Reading Internal Update Rate	337
POS: Computed Position Data	338
PPS: PPS Settings	339
PRT: Baud Rate Settings	340
PTT: PPS Time Tag	341
PWR: Power Status.....	342
RAW: Raw Data Logging Settings.....	343
RCP: Receiver Parameters.....	344
RCP,OWN: Receiver Name	345
RCP,REF: Reference Receiver Name.....	345
RDP,CHT: Radio Channel Table.....	346
RDP,LVL: Reading the Radio Reception Level	348
RDP,PAR: Radio Parameters	348
RDP,TYP: Radio Type Used.....	351
REC: Raw Data Recording Status.....	353
RID: Receiver Identification	353
RMC: Recommended Minimum Specific GNSS Data	354
RNX,MSI: ATOM RNX Differential Message.....	356
RRE: Residual Error	356
RTC: RTCM Status	357
RTC,MSI: RTCM Message Status	359
RWO: Raw Data Output Settings	360
SAT: Satellites Status	361
SBA: SBAS Tracking Status	362
SGA: GALILEO Satellites Status	363
SGL: GLONASS Satellites Status	364
SGP: GPS & SBAS Satellites Status.....	366
SIT: Site Name	368
SNM: Signal-to-Noise Ratio Mask	369
SOM: Signal Observations Masking	370
SOM,CTT: Cumulative Tracking Time Mask.....	370
SOM,NAV: Navigation Data Mask.....	371
SOM,SNR: Signal-to-Noise Ratio Mask	372
SOM,WRN: Channel Warnings Mask.....	373
STI: Station ID.....	374
SVM: Satellite Use Mask.....	374
UDP: User-Defined Dynamic Model.....	375
UNT: Distance Unit Used on Display Screen	376
UTS: GPS Time Synchronization Status.....	376
VEC: Vector & Accuracy Data.....	377
VERSION: Firmware Version	379
VTG: Course Over Ground and Ground Speed	380
WARN: Warning Messages.....	381
ZDA: Time & Date	381

Appendix D. Output Message Library	383
ION: Ionosphere Parameters	383
MPC: GNSS Measurements	385
DPC: Compact GPS Measurements.....	388
PBN: Position Information.....	390
SBA,DAT: SBAS Data Message	391
SAL: GPS Almanac Data	392
SAG: GLONASS Almanac Data.....	393
SAW: SBAS Almanac Data	395
SNG: GLONASS Ephemeris Data	397
SNV: GPS Ephemeris Data	399
SNW: SBAS Ephemeris Data	401



Chapter 1. Introduction



What is ProMark 800?



Congratulations! You have just acquired the latest multi-frequency, multi-constellation ProMark 800 GNSS Surveying System from Ashtech!

GNSS has revolutionized control surveys, topographic data collection and construction surveying. Purchasing the right tools for a professional job is essential in today's competitive business environment. Learning to put these tools to work quickly and efficiently will be the focus of the present manual.

Compared to ProMark 500, ProMark 800 integrates the so-called "GNSS-centric" new technology, known as Z-Blade™. By allowing the receiver to better combine all the signals available from the different visible GNSS constellations, Z-Blade will allow you to improve your field productivity.

In addition, because it's easy to use, you will be able to focus on your job and forget almost everything about the technical aspects of your equipment. No more cables, no more clip-on modules: ProMark 800 will be the reliable tool you are expecting for all your GNSS survey operations!



System Components Overview

The tables below provide an overview of the different key items composing the ProMark 800.

Depending on your purchase and based on the type of survey you wish to perform, you may only have some of the listed items. Please refer to the packing list for an accurate description of the equipment that has been delivered to you.

NOTE: Ashtech reserves the right to make changes to the list of items provided below without prior notice.





Basic Supply

Item	Part Number	Picture
ProMark 800 GNSS receiver with standard accessories	990657	
7.4 V-4.4 Ah Li-ion Battery Pack (rechargeable)	111374	



Accessories, General Purpose

Item	Part Number	Picture
AC/DC Power Supply Kit (includes external AC adapter, battery charger and cable extension for powering ProMark 800 directly from the AC adapter)	802064	
USB Host to Device Cable (short).	702104	
USB Device to PC Cable (long)	702103	
HI Measurement Tool	111146-1	
Vertical Antenna Extension	103717	
Field bag	205923 or 206490	

Communication Modules and Associated Antennas

Item	Part Number	Picture
U-Link TRx, 12.5-kHz channel bandwidth	Transmitter: 802080-10 (0.5/2/4W; 410-430 MHz) 802080-30 (0.5/2/4W; 430-450 MHz) 802080-50 (0.5/2/4W; 450-470 MHz) Repeater: 802106-10 (0.5/2/4W; 410-430 MHz) 802106-30 (0.5/2/4W; 430-450 MHz) 802106-50 (0.5/2/4W; 450-470 MHz) Each P/N includes a whip antenna, and an antenna bracket. The Y-shaped power/ data cable is an integral part of the trans- mitter (no connector).	 <p>Picture of transmitter with its cable</p>
Pacific Crest Transmitter, 25-kHz channel bandwidth	110972-30 (35 W, 430-450 MHz) 110972-50 (35 W, 450-470 MHz) Each P/N includes a whip antenna, an antenna bracket and an OEM Y-shaped data/power cable.	 <p>Picture of transmitter alone</p>
Radio receiver kit (includes radio module, whip antenna and small parts)	U-Link Rx: 802150-10 (410-430MHz, 12.5 kHz) 802150-30 (430-450 MHz, 12.5 kHz) 802150-50 (450-470 MHz, 12.5 kHz) PacCrest: 802149-30 (430-450 MHz, 12.5 kHz or 25 kHz) 802149-50 (450-470 MHz, 12.5 kHz or 25 kHz)	
Quad-band GSM antenna	111397	

Base Accessories

Item	Part Number	Picture
External DC Power Cable for Receiver (fuse included)	730477	
Power cable kit, will gradually replace 730477	802143	

Using the ProMark 800 Carrying Case

This section shows how to arrange the different pieces of equipment in the ProMark 800 carrying case when it's fitted with preformed foam blocks.

Another model of carrying case also exists, designed to accommodate two field bags side by side. With this type of case, once your field bags are ready, just place them inside and close the case securely.

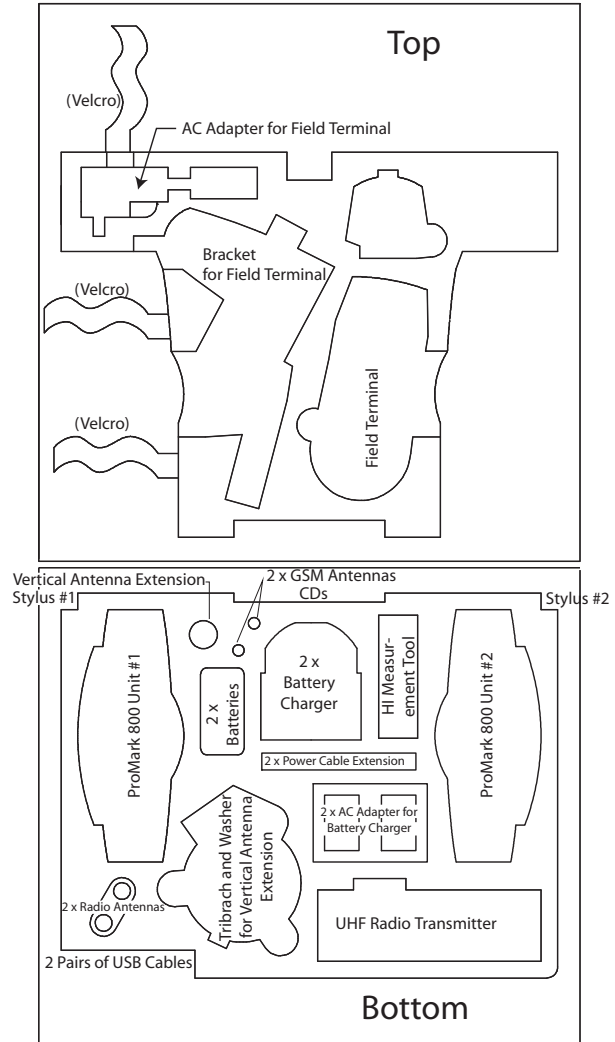

Equipment Description & Basic Functions

Front Panel View

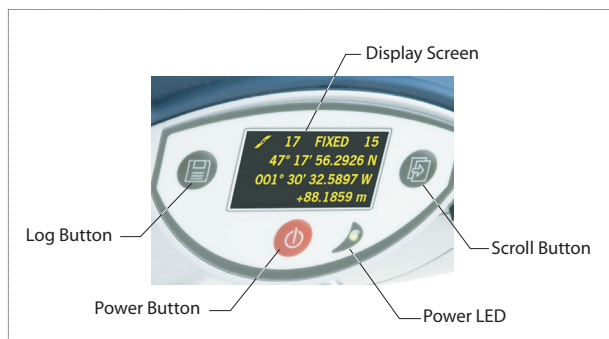

Indicators & Controls



Power button

To turn on the ProMark 800, hold the Power button pressed until the power LED lights up.

To turn off the ProMark 800, hold the Power button pressed until the “Ashtech” screen is displayed. Then release the button and wait until the ProMark 800 shuts down.

Power LED

This indicator is on when the ProMark 800 is on, and off when it is off.



Display Screen

The display consists of a 128 x 64-pixel, 1.5-inch monochrome yellow screen using organic LED technology (OLED). It is oriented slightly downwards so the screen can easily be read when the ProMark 800 is installed on top of a range pole.

Used in conjunction with the Scroll button, the display screen allows you to view different pages of information. See *Display Screens on page 9* for a detailed description of the information available from this screen.



After a few seconds of inactivity (i.e. Scroll button idle), screen luminosity turns from high to low level.

Scroll button

Press this button shortly to scroll through the different pages of information viewed on the screen.



If an alarm is reported on the display screen, a short press on the Scroll button will acknowledge the alarm. The Scroll button will recover its display scrolling function only after all the alarms have been acknowledged this way.

Another function of the Scroll button is to re-activate the screen backlight after the latter has automatically been turned off. The Scroll button is also used in the firmware update procedure.

Log Button

Press this button briefly to start recording raw data on the selected storage medium.



Another short press on this button will immediately stop raw data recording.

Buzzer

The internal buzzer will sound an alarm whenever a warning message is reported on the screen. The buzzer will beep until you acknowledge the warning message by pressing the Scroll button. The buzzer can be deactivated permanently using the `$PASHS,BEEP` command. See *BEEP: Beeper Setup on page 169*.

Bottom View

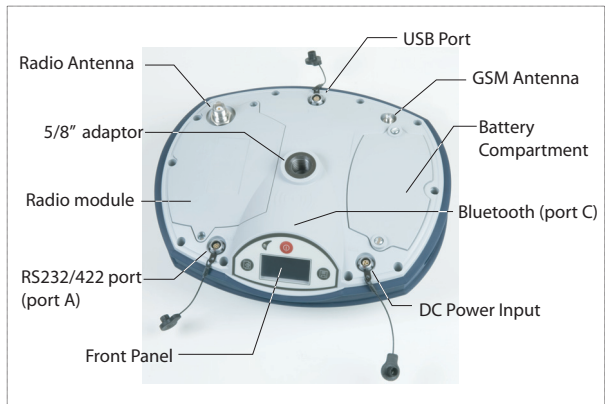

Battery, Connectors & Module

Battery Model & Battery Compartment

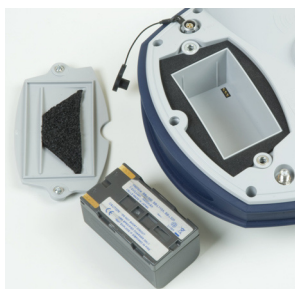

The battery used in the ProMark 800 is a 7.4-V DC - 4600 mAh rechargeable battery. It is a standard model used in many camcorders.

The battery is housed in a battery compartment accessible from underneath the ProMark 800. The compartment door can be removed using a coin to release the two quarter-turn screws.

DC Power Input

A three-contact, female connector (Fischer type) allowing the ProMark 800 to be powered from either the provided AC adapter (connect the cable extension between ProMark 800 and the end of the AC adapter output cable), or an external 9- to 28-V DC battery through cable P/N 730477 (cf. base configuration with radio).

GSM Antenna

A coaxial female connector (SMA type) allowing you to connect a GSM whip antenna to the ProMark 800.

Radio Antenna

A coaxial female connector (TNC type) allowing you to connect a radio whip antenna to the ProMark 800. This connector is available only if the ProMark 800 has been fitted with a radio module.

Radio Module

A module allowing ProMark 800 to receive and process corrections from a base. When a radio module is used, a radio antenna must be connected (see above). When no radio receiver kit is delivered, a single compartment door is provided instead, with no connector on it.

USB Port

A nine-contact female connector (Fischer type). Depending on how it is configured, the USB port can be used in two different ways:

1. For a USB host such as a mass storage device. In this case, you should use the special adaptor cable provided (P/N 702103) to attach the USB key to the ProMark 800. This configuration can be used to log raw data on the USB key or upgrade the ProMark 800 firmware from the files stored on the key.
2. For a USB device allowing ProMark 800 to be seen as a disk from the computer connected to this port. In this configuration, files can be transferred between the ProMark 800's internal memory and the computer using the USB cable provided (P/N 702104).

RS232/422 Serial Port

A seven-contact female connector (Fischer type) allowing you to connect the ProMark 800 to an external device via an RS232 or RS422 serial line (default: RS232). Changing the configuration of the port can be done from the field terminal using the \$PASHS,MDP serial command. See *MDP: Setting Port A to RS232 or RS422 on page 207*.

Bluetooth Device

An integrated Bluetooth module allowing the ProMark 800 to communicate with a Bluetooth-enabled field terminal through a wireless connection.

Antenna Characteristics

The diagram below gives the dimensional parameters of the ProMark 800 antenna required for the system to determine the true height of the antenna from the measured value obtained using one of the standard height measurement methods, i.e. slant or vertical.

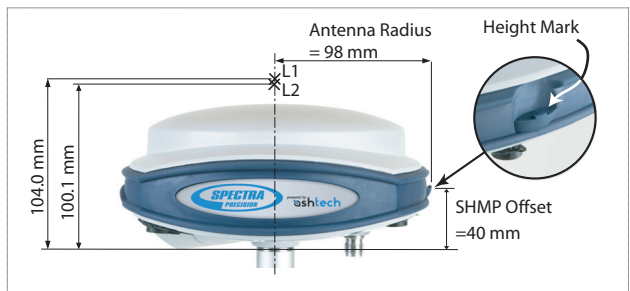

The height mark allows you to hook the measure tape onto it so you can unroll the tape down to the survey mark and read the slant height measurement directly on the tape.

Special Button Combinations

- With the ProMark 800 OFF, pressing the Power, Log and Scroll buttons simultaneously for a few seconds will restore all the factory settings. **Always use this combination after changing the radio module.** This allows the receiver to recognize the new module.
- With the ProMark 800 OFF and a USB key connected, pressing the Power and Scroll buttons simultaneously for a few seconds will cause the ProMark 800 to start a firmware upload process. If there is no USB key connected or the key does not contain a firmware upgrade, then the process will abort after a few seconds.
Because data has to be decompressed on the USB key during upgrades, the USB key must be unlocked, with at least 10 MBytes of free memory, before starting the upgrade.

These button combinations are summarized in the table below:

Button Combination	ProMark 800 State	Function
Power+Log+Scroll	OFF	Restores Factory Settings.
Power+Scroll	OFF	Initiates firmware update from USB key.

Display Screens

If you press the Scroll button several times, you will see the following displays successively.

Power-On Screen

When you power on the receiver, the Ashtech logo appears on the screen. It is displayed until the receiver has completed its auto-test (this takes about 30 seconds).





Then the General Status screen is displayed.

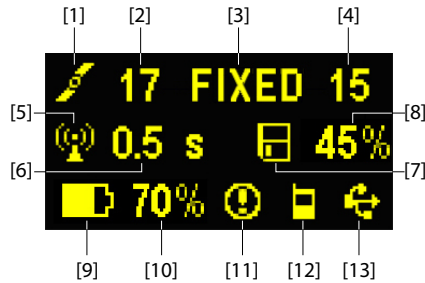

General Status Screen

An example of General Status screen is shown below.





This screen displays the following information:

- : Satellite icon [1] (always displayed).
- Number of satellites tracked [2].
- Position solution status [3]:
 - NONE: Position not available
 - AUTO: Autonomous GPS position
 - DGPS: Differential GPS position
 - S DGPS: SBAS Differential GPS position
 - FLOAT: Float solution
 - FIXED: Fixed solution (RTK is operational)
 - BASE: Receiver configured as a base.
- Number of satellites used [4]: Number of satellites used in the position processing, regardless of the current position solution status.
- : Data link icon [5]. This icon is displayed only when corrections are received.
- Age of corrections [6], in seconds. This value is displayed when corrections are received and only after base station information has been received (Position status is at least “DGPS”).
- Raw data logging icon [7]:

	Data recording through front panel Log button: <ul style="list-style-type: none"> – Blinking: Raw data logging in progress – Fixed: No raw data logging in progress.
	ATL data recording for advanced diagnosis.

- Percentage of free memory in the storage medium used [8].

- : Battery icon [9] with visual indication of remaining charge. If an external power source is used (AC adapter or external battery), the battery icon will be animated to indicate battery charging in progress.

 is displayed when there is no battery in the compartment and the receiver is operated from an external power source.





- Power status [10].

Icon	Definition
Percent value	Percentage of remaining battery. This indication will flash when the remaining energy drops below 5%. When an internal battery is used with external power applied, this icon alternates between the plug and the percentage of charge on the battery.
	Replaces percentage when an external power source is used.



- Alarm status [11].

Icon	Definition
	Alarm detected. Press the Scroll button to view the alarm type. Press it again to acknowledge the alarm, which then disappears from the list. Unless there is another alarm in the queue, in which case you will have to resume the acknowledge sequence, the screen then displays the memory screen.
None	No alarm detected

- GSM module (modem) status [12]. This may be one of the following icons:

Icon	Definition
Blank	Modem turned off.
	Blinking icon: Modem turned on but not initialized yet. Indicates signal strength at modem antenna input.
	Fixed icon: Modem turned on and initialized (ready for a connection). Indicates signal strength received at modem antenna input. The higher the number of bars, the better the signal. This icon will show four dots at the bottom when the input signal is zero.
	The symbol shown in the upper left corner stands for "2G". When the modem detects a 3G network, "3G" is displayed instead.
	Modem on line.

- [13]: USB status and/or Bluetooth status.

Icon	Definition
	USB port connected to active device
	Bluetooth active

Icon	Definition
	These two icons will appear successively when both the USB port and Bluetooth are active.
Blank	USB port unconnected and Bluetooth inactive.

Memory Screens

From the General Status screen, press the Scroll button to access the Memory screens. Memory screens appear successively (see examples) at a display rate of about five seconds:



Left screen:

- First line: Percentage of free space in the internal memory.
- Second line: Number of files currently stored in the internal memory.
- Third line: Percentage of free space on the USB mass storage device.
- Fourth line: Number of files currently stored on the USB mass storage device.

Right screen:

- First line: Total space occupied by the files currently stored in the internal memory.
- Second line: Nominal size of the internal memory.
- Third line: Total space occupied by the files currently stored on the USB mass storage device.
- Fourth line: Nominal size of the USB mass storage device.

About the “*” symbol:

- It can only appear at the end of the first or third line.
- Where placed, it indicates that this storage medium is used for data logging.

What if there is no USB mass storage device connected to the receiver?

- Parameters relevant to the USB key size and space used and available are void (three dots displayed instead).
- Number of files is forced to “0”.

Receiver Identification Screen

From any of the two Memory screens, press the Scroll button to access the Receiver Identification screen. See example below.

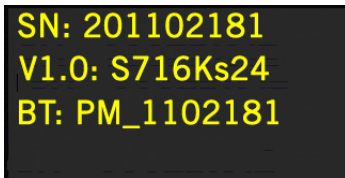

SN: 201102181
V1.0: S716Ks24
BT: PM_1102181

- Receiver Serial Number
- Firmware Version
- Receiver Bluetooth Identifier

Position Computation Screen

From the Receiver Identification screen, press the Scroll button to access the Position Computation screen. This screen displays the latitude, longitude and ellipsoidal height of the position currently computed by the receiver. If the receiver is a base, the displayed coordinates are set ones (not computed ones) representing the reference position assigned to the base. See example below for a rover.



17 FIXED 15
47° 17' 56.2926 N
001° 30' 32.5897 W
+88.1859 m

The upper line contains the same information as in the upper line of the General Status screen.

A new press on the Scroll button will take you to the ATL Recording screen (see below). If however the receiver is fitted with a radio receiver or is connected to an external radio transmitter, an additional display screen will show up before pressing the Scroll button takes you back to the ATL Recording screen.

D Rx ADL ON	A Tx U-Link
O 446.7750Mhz	O 446.7750Mhz
TRANS 4800bds	TRANS 4800bds
MED FEC SCR	MED

The possible two screens show the current radio settings:

- First line: Serial port used, “Rx” for radio receiver or “Tx” for radio transmitter, radio type (U-Link, PDL, etc.). Extra-parameter for “Rx”: Power status
- Second line: Channel number, carrier frequency
- Third line: Protocol used (Transparent, Trintalk, DSNP, etc.), airlink speed
- Fourth line: Squelch setting (medium, low, high). Extra-parameters for Rx if a Pacific Crest: “FEC” if forward error correction enabled, “SCR” if scrambling enabled. Modulation type (GMSK, 4FSK). The fourth line will be slowly scrolled to the right if four parameters have to be displayed in the line.

ATL Recording Screen

Pressing the Scroll button from the Position Computation screen –or from the Radio Settings screen if there is a radio used– will take you to the ATL Recording screen, which looks like one of the following, depending on whether a USB key is connected to the receiver (below, right) or not (below, left).

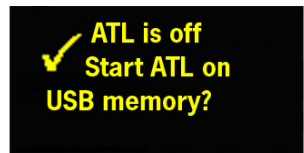
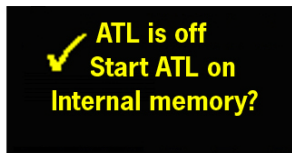

You don’t normally have to record ATL data, but if for troubleshooting purposes, the Technical Support asks you to do so, then proceed as follows:

- Press the Log button (left-hand button). This will cause the receiver to start recording ATL data on the specified storage medium. The screen will then look like this:

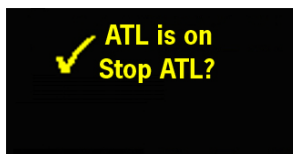

You can then freely use the Scroll button to access other receiver screens without affecting the ATL data collection in progress (pressing the Scroll button from this screen will take you back to the General Status screen).

- When enough ATL data have been recorded (Tech Support will usually indicate the duration of ATL data collection needed for troubleshooting), then come back to the ATL Recording screen and simply press on the Log button again to stop the recording.

NOTE 1: ATL data recording is totally independent of raw data recording: controlling ATL recording is done exclusively from the ATL recording screen, and raw data recording from any other screen.

NOTE 2: Before connecting a USB key to record ATL data, make sure there is no *.par files saved on the key as the presence of this type of file would initiate some other functions in the receiver (refer to .

Screen Backlight

The screen backlight is automatically turned off if no key is pressed for 1 minute. When the backlight is off, a short press on the Scroll button will turn it back on. The Scroll button will then recover its usual functions.

Data Transfer Screen

For more information on the screen displayed when downloading files, refer to *Downloading Raw Data on page 37*.

Charging Batteries Before Use

Make sure the battery is fully charged for each ProMark 800 you will be using in the field. Follow the instructions below to charge a battery.

Removing the Battery from the ProMark 800

Unless the battery has already been taken out, do the following:

- Put the ProMark 800 upside down.

- Remove the battery door, accessible from underneath the ProMark 800, by loosening the two quarter-turn screws (see picture) using a coin.



- Keeping one hand on the battery still in its compartment, put the ProMark 800 the right way up. The battery will then easily slide out of the battery compartment.

Charging the Battery

The battery charger comes with a separate universal AC adapter fitted with a 1.5-m output cable. The AC adapter includes a choice of four different, detachable plug types. Follow the instructions below to operate the charger.

- Choose the plug type that is suitable for your country.
- Secure that plug on the AC adapter by giving the plug the right orientation with respect to the adapter, then pushing and rotating it by about 10 degrees clockwise until you hear a “click”.
- Connect the cable from the AC adapter to the battery charger.
- Give the battery the right orientation with respect to the charger **[1]** (the battery terminals should come into contact with the two sets of connectors on the charger), then push the battery against the plate and slide it forward **[2]** until it locks into place.

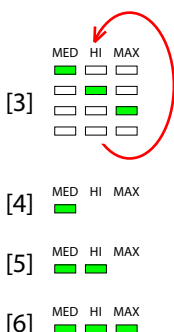
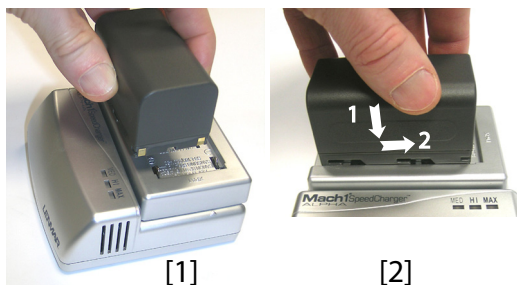

- Plug the adapter into an AC outlet. Battery charging starts immediately.

For a low battery that's being charged, you will first see the three LEDs switch on and off, one after the other, followed by a short period of time when none of the LEDs is on (see [3]).

After about two hours of charging, the MED LED will stay on [4]. A few minutes later, the HI LED [5], and then the MAX LED [6] will also stay on.

- When the three LEDs are on, this means the battery is fully charged and can be disconnected from the charger.

Inserting the Battery in the ProMark 800

- With the ProMark 800 upside down, insert the battery into the compartment making sure the battery has the right orientation (the battery terminals should come into contact with the two sets of connectors located at the bottom of the compartment).
- Place the battery door over the battery and tighten the two screws, using a coin. Note that, once it is properly secured, the battery door pushes the battery against the bottom of the compartment to ensure electrical connection of the battery to the ProMark 800.

Specifications

GNSS Characteristics

- 120 GNSS channels:
 - GPS L1 C/A L1/L2 P-code, L2 C, L5, L1/L2/ L5 full wavelength carrier
 - GLONASS L1 C/A and L2 C/A, L1/L2 full wavelength carrier

- GALILEO E1 and E5 (including GIOVE-A/GIOVE-B test satellites)
- SBAS: code and carrier (WAAS/EGNOS/MSAS)
- New Z-Blade technology for optimal GNSS performance
 - New Ashtech GNSS centric algorithm: Fully independent GNSS satellites tracking and processing ¹.
 - Fully independent code and phase measurements
 - Quick signal detection engines for fast acquisition and re-acquisition of GNSS signals
 - Advanced multipath mitigation
- Up to 20 Hz real-time raw data (code and carrier) and position output
- Supported data formats: ATOM (Ashtech Optimized Messaging), RTCM 2.3, RTCM 3.1, CMR, CMR+, DBEN, LRK
- NMEA 0183 messages output
- RTK networks: VRS, FKP, MAC.

Real-Time Accuracy (RMS)

See footnotes ² and ³.

SBAS (WAAS/EGNOS/MSAS)

- Horizontal: < 50 cm (1.64 ft)

Real-Time DGPS Position

- Horizontal: 25 cm (0.82 ft) + 1.0 ppm in typical conditions

Real-Time Kinematic Position (Fine Mode)

- Horizontal: 10 mm (0.033 ft) + 1.0 ppm
- Vertical: 20 mm (0.065 ft) + 1.0 ppm

Real-Time Performance

Instant-RTK® Initialization

- Independent of GPS availability when other GNSS signals are available ⁴
- Typically 2-second initialization for baselines < 20 km
- 99.9% reliability

1. Each GNSS constellation is processed equally, individually and combined for optimal performance.

2. Accuracy and TTFF specifications may be affected by atmospheric conditions, signal multipath, satellite geometry and corrections availability and quality. Position accuracy specifications are for horizontal positioning. Vertical error is typically less than twice the horizontal error.

3. Performance values assume minimum of five satellites, following the procedures recommended in the product manual. High multipath areas, high PDOP values and periods of severe atmospheric conditions may degrade performance.

4. Each GNSS constellation is processed equally, individually and combined for optimal performance.

RTK initialization range

- > 40 km

Post-Processing Accuracy (RMS)

See footnotes ¹ and ².

Static, Rapid Static

- Horizontal: 5 mm (0.016 ft) + 0.5 ppm
- Vertical: 10 mm (0.033 ft) + 1.0 ppm

Long Static ³

- Horizontal: 3 mm (0.009 ft) + 0.5 ppm
- Vertical: 6 mm (0.019 ft) + 0.5 ppm

Post-Processed Kinematic

- Horizontal: 10 mm (0.033 ft) + 1.0 ppm
- Vertical: 20 mm (0.065 ft) + 1.0 ppm

Data Logging Characteristics

Recording Interval:

- 0.05 to 999 seconds

Physical Characteristics

- Size: 22.8 x 18.8 x 8.4 cm (9 x 7.4 x 3.3 ")
- Weight: 1.4 kg (3.1 lb)

User Interface

- Graphic OLED display

I/O Interface

- RS232, RS422, USB, Bluetooth
- 1PPS output

Memory

- 128-MByte internal memory (expandable through USB)
- Up to 400 hours of 15-s GNSS raw data from 18 satellites

Operation

- RTK rover/base, post-processing
- RTK network rover: VRS, FKP, MAC
- Point-to-Point through Real-time Data Server (RTDS) Software
- Limited RTK as standard (baseline: 3 km)
- RTC Bridge
- NTRIP protocol

1.Accuracy and TTFF specifications may be affected by atmospheric conditions, signal multipath, satellite geometry and corrections availability and quality. Position accuracy specifications are for horizontal positioning. Vertical error is typically less than twice the horizontal error.

2.Performance values assume minimum of five satellites, following the procedures recommended in the product manual. High multipath areas, high PDOP values and periods of severe atmospheric conditions may degrade performance.

3.Long baselines, long occupations, precise ephemeris used.

- Rover can decode RTCM messages 1021, 1022 and 1023 so that its position may be computed in the same local coordinate system as the one used at the base station.

Environmental Characteristics

- Operating temperature: -30° to +55°C (-22° to +131°F)
- Storage temperature: -40° to +85°C (-40° to +158°F)
- Humidity: 100% condensing
- Waterproof, sealed against sand and dust
- Shock: ETS300 0.19
- Vibration: EN60945

Power Characteristics

- Li-ion battery, 4600 mAh
- Battery life time: 8 hrs (GSM and UHF off)
- 6-28 VDC input

Optional System Components

- Communication Modules:
 - U-Link Rx
 - Pacific Crest UHF
 - GSM/GPRS/EDGE/3.5G quad-band
- Transmitter Kits
 - U-Link TRx
 - Pacific Crest UHF
- Rechargeable battery kit
- Field terminal kit with FAST Survey ¹
 - ProMark 100
 - MobileMapper 10
- Field terminal kit with Survey Pro ²
 - Ranger 3
 - Nomad™

1. Available within Ashtech distribution channels.

2. Available within Spectra Precision distribution channels.

Firmware Options

The pre-installed and optional firmware modules are listed in the table below.

ID	Label	Description	P/N	Pre-installed
K	Unlimited RTK	Allows a base to generate and send RTK correction data. Allows a rover to compute RTK position solutions using corrections received from a base.	680502	No
F	FASTOUT-PUT	Allows position output at a rate of up to 20 Hz.	680527	No
Z	MODEM	Enables the use of the internal GSM/GPRS modem	680528	No
S	GLONASS	Enables the use of signals from the GLONASS constellation	680500	No
P	GNSSSL2	Enables the reception of the L2 frequency	-	Yes
M	RTK2	RTK computation with proprietary messages (ATOM, DBEN, LRK). Generates proprietary messages (ATOM).	-	Yes
L	RTK3	Limits RTK range to 3 km	-	Yes
N	STA	Enables a base receiver to generate RTCM, CMR or ATOM corrections data.	-	Yes
O	GALILEO	Enables Galileo tracking.	-	Yes*
Q	GNSSSL5	Enables L5 tracking.	-	Yes*

*: Pre-installed options, but by default will expire after three months of use.

Enabling a firmware option purchased separately from the system relies on the use of the \$PASHS,OPTION serial command. For more information on how to enable an option, refer to *OPTION: Receiver Firmware Options on page 218*. IMPORTANT! After enabling firmware option [F] to enable fast position output, the \$PASHS,POP,20 command *must* be run to make the fast output effective.

U-Link Radios

U-Link TRx Specifications



Radio specifications:

- Frequency range: 410 to 470 MHz, with factory adjustment of input filter in ± 2.5 -MHz steps
- Channel spacing: 12.5 kHz
- RF link speed: 4800, 7600 or 9600 bps
- Modulation: GMSK
- Two operating modes: DSNP or Transparent
- Serial link speed: 38400 bps
- Serial link: RS232 or RS422
- Adjacent channel power: > 60 dBc
- RF connector type: TNC
- Two transmitter status LEDs (Type of RS connection, data transfer, repeater mode)

Configuration tool:

- Ashtech radio configuration software used to set channels and output power
- Up to 16 channels can be saved in the radio
- Radio output power : 0.5 W, 2 W or 4 W

Power requirements:

- DC input voltage range: 9-28 V
- Power consumption: 1.5 A @ 12 V DC and 4 W RF

Physical characteristics:

- Size: 150 x 105 x 48 mm (5.9 x 4.1 x 1.9")
- Weight: 660 grams (23.3 oz)

Environmental specifications:

- Sealing: IP65
- Full performance from -20°C to $+55^{\circ}\text{C}$
- Extended temperature range from -30°C to $+55^{\circ}\text{C}$
- CE, FCC and IC marked
- EN300-113 certified
- Shock: ETS300019 - 0107
- Vibrations: MIL-STD 810F

U-Link Rx Specifications

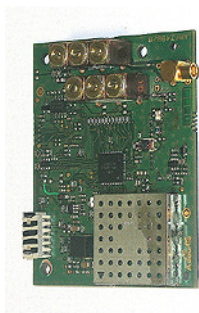

The U-Link Rx basically is an electronic board with the following specifications:

Radio Specifications:

- Frequency range: 410 to 470 MHz, with factory adjustment of input filter in ± 2.5 MHz steps
- Sensitivity: -114 dBm at 10^{-5} BER
- Channel spacing: 12.5 kHz
- RF link speed: 4800, 7600 or 9600 bps
- Modulation: GMSK
- Operating modes: DSNP or Transparent
- Serial link speed: 38400 bps
- Serial link: RS232
- Up to 16 channels can be saved in the radio
- Adjacent channel power: > 60 dBc
- Ashtech radio configuration software used to set channels.

Configuration Tool:

- Ashtech radio configuration software used to set channels and output power
- Up to 16 channels can be saved in the radio

Power requirements:

- DC input voltage range: 5.5 to 9 V
- Power consumption: < 700 mW

Physical characteristics:

- Size: 76 x 65 x 20 mm (3 x 2.6 x 0.8")
- Weight: 50 grams (1.76 oz)

Environmental specifications:

- Full performance from -20°C to +55°C
- Extended temperature range from -30°C to +55°C
- CE, FCC and IC marked
- EN300-113 certified

Channel Settings

Once the central frequency has been set, the chosen channels can only be located ± 2.5 MHz around the central frequency.

Only certified dealers are authorized to set the central frequency and channels. For both settings, the radio

configuration software is used. Setting the central frequency requires additional instrumentation.

The central frequency of the U-Link TRx can be read on the label placed on the transmitter case.

The central frequency of both the U-Link TRx and U-Link Rx can be read using the \$PASHQ,RDP,PAR command (the central frequency setting is the last parameter in the response line).

U-Link TRx LEDs



Two LEDs located at the bottom of the case are used to indicate the current status of the radio:

- **ON indicator:** a bi-color LED indicating power status and serial port type. It is off when no power is applied to the U-Link TRx. It is on when power is applied through the cable. The LED color then depends on the current setting of the serial port: green if it is of the RS232 type, or red if it is of the RS422 type.
- **TX-RX indicator:** a bi-color LED indicating the current transmission/reception status of the U-Link TRx. It is on and red while data are being transmitted; it is on and green while the U-Link TRx is properly receiving and decoding data. In repeater mode, the LED should change color at regular intervals of time (typically 1 second).

U-Link TRx Cable Pinout and Hardware Settings

The diagram below shows the pinout of the Y-shaped cable, an integral part of the U-Link TRx, when the unit is configured in RS422. The diagram also shows the location of the hardware settings as well as the RS232 pinout in the unit.

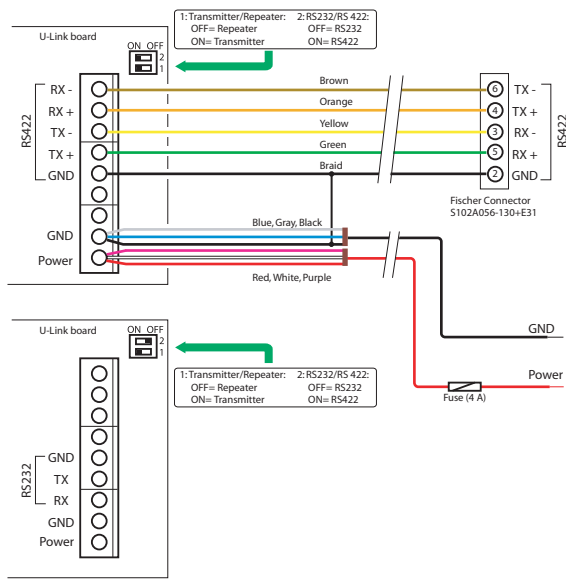

Port Pinouts

NOTE: All illustrations below show connectors seen from outside the receiver case.

Power 3-C Connector, Type: Fischer DBPU 102 A052-139

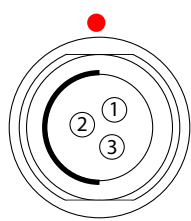
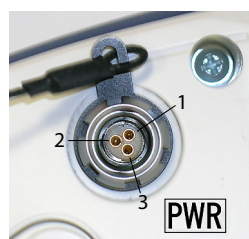

Pin	Signal Name	Description
1	GND	External Power Ground
2	PWR	External Power Input (10-28 V DC)
3	-	Mandatory! Leave this pin unconnected.

RS Port (Port A) 7-C Connector, Type: Fischer DBPU 102 A056-139

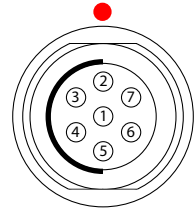
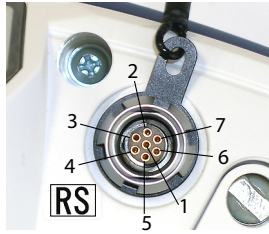

RS232 Configuration:

Pin	Signal Name	Description
1		NC
2	GND	Ground
3	CTS	Clear To Send
4	RTS	Request To Send
5	RXD	Receive Data
6	TXD	Transmit Data
7	PPS	1PPS output

RS422 Configuration:

Pin	Signal Name	Description
1		NC
2	GND	Ground
3	RXD-	Receive Data-
4	TXD+	Transmit Data+
5	RXD+	Receive Data+
6	TXD-	Transmit Data-
7	PPS	1PPS output

USB Port

USB 2.0, full speed.

9-C Connector, Type: Fischer DBPU 102 A059-139

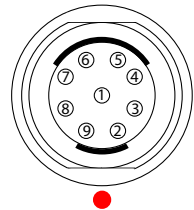
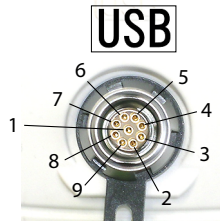

Pin	Signal Name
1	NC
2	GND

Pin	Signal Name
3	Device (D+)
4	Device (D-)
5	Host (VBus)
6	Host (D+)
7	Host (D-)
8	Device Detection
9	NC



Chapter 2. RTK Surveying Preliminary Steps



Introduction

ProMark 800 can be used in conjunction with two different field software applications running on your field terminal:

- Ashtech FAST Survey
- Spectra Precision Survey Pro

This chapter describes the preliminary steps required before starting using your RTK surveying equipment. Two different setups are presented:

- RTK Base setup: If you are using your own base and a radio link, you need to set up your base first. (If you are working in a third-party network or using corrections from a third-party reference station, you don't need to set up a base.)

Once you are finished with the base setup, refer to the documentation corresponding to the field software used for more information on how to complete the base configuration and let the base operate on its own.

- RTK Rover setup: This is a mandatory step whatever the field software and field terminal used.

Once you are finished with the rover setup, please refer to the documentation corresponding to the field software used for more information on how to complete the rover configuration and learn how to complete an RTK job with this software.

RTK Base Setup

Prerequisites

- You will need a tripod and a tribrach (not provided) to install the base. The provided antenna extension pole fitted with a 5/8" male adaptor is also required in this configuration.
- For a long-range radio link, i.e. more than 1 mile or 1.6 km, for which the radio antenna should be placed as high as possible, it is good practice to install the antenna on top of an antenna pole secured on a tripod (neither of these items is provided).
- To power the radio, you need an external 9-28 V DC (U-Link TRx), 10-16 V DC (Radio P/N 800986-x0) or 9-16 V DC (Pacific Crest radio) power source. In all cases, using a standard 12-V DC battery is a convenient choice. In this configuration, the ProMark 800 can be powered either from the same power source (recommended), using cable P/N 730477, or from its internal battery.

Powering the ProMark 800 from the external battery offers two advantages:

1. Operating sessions can be extended significantly.
2. The external battery operates as a trickle charger for the ProMark 800's internal battery.

U-Link TRx The connection diagram is as follows.

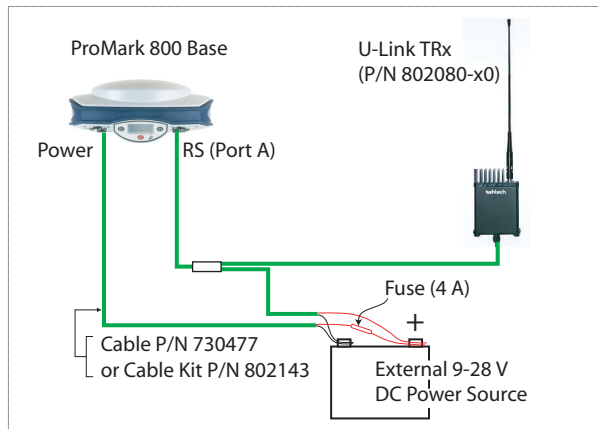

Mount the different items as shown on the picture.



PacCrest Radio Link

The connection diagram is as follows.

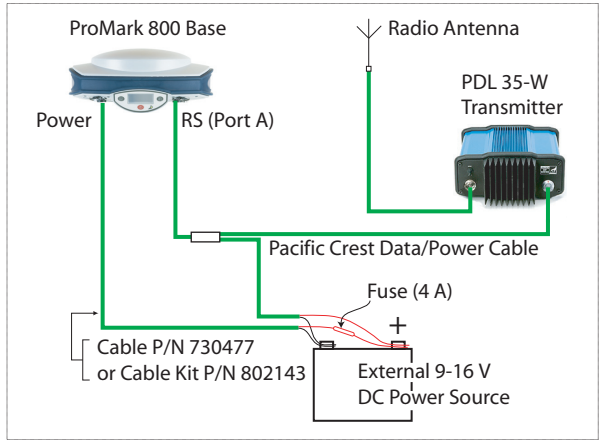

Mount the different items as shown on the picture.



RTK Rover Setup

Prerequisites



- Use a range pole fitted with a 5/8" male adaptor at the upper end (not provided).
- If a radio link is used with the base, your rover should normally have been fitted with the radio module that matches the reception band covered by the radio transmitter used at the base.
- If a GPRS connection is used, your rover should normally have been fitted with the SIM card that will allow it to perform a network connection.

To connect the SIM card, first use a flat screwdriver to loosen the two quarter-turn screws securing the radio module. Remove the module. This gives access to an electronic card on which you can insert the SIM card as shown on the picture.

Radio Link

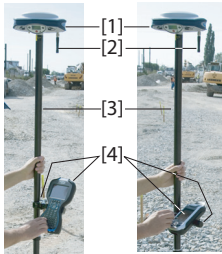

Mount the different items as shown on the picture, including the ProMark 800 [1], the radio antenna [2], the range pole [3] and the field terminal with its mounting bracket [4].

Caution! Use of a non-metal range pole is recommended to maintain the performance level of the radio antenna.

GSM/GPRS Connection

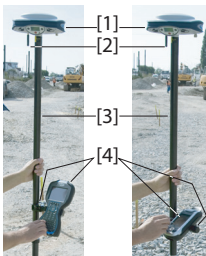

As a standard feature, the ProMark 800 incorporates a built-in GSM modem, which means you only have to connect the GSM antenna if you have paid for activation of the hardware. Mount the different items as shown on the picture, including the ProMark 800 [1], the GSM antenna [2], the range pole [3] and the field terminal with its mounting bracket [4].

Caution! Use of a non-metal range pole is recommended to maintain the performance level of the GSM antenna.



Chapter 3. Post-Processed Surveying



Introduction

ProMark 800 can be used either as a base or a rover for collecting raw data in post-processed surveys.

Post-processed surveys with ProMark 800 can be performed either with a standalone ProMark 800, or with a ProMark 800 used in conjunction with a field terminal running a field software application.

The standalone configuration is enough for both static and continuous kinematic surveys, but for stop & go kinematic surveys, you need the field terminal and its field software to mark the static occupations.

Generally speaking, using a field terminal and its field software is also more convenient in static and continuous kinematic than using a standalone ProMark 800.

The following field software applications can be used to perform post-processed surveys with ProMark 800:

- Ashtech FAST Survey
- Spectra Precision Survey Pro

For more information on how to use these applications in post-processed surveys, refer to their respective documentation.

The present chapter deals with the following three topics:

- Receiver setup for static (base, rover) and kinematic (rover) post-processed surveys, with or without a field terminal.
- Collecting raw data with a standalone ProMark 800.
- Downloading the raw data collected by a standalone ProMark 800.

System Setup

Base Setup

This setup should always be used for a base and may also be used for a rover having to run a static survey.

Prerequisites:

- You need accessories to install the base, such as a tripod, a tribrach and an antenna pole.
- Allow for an external DC power source if this is how you want the base to be powered. Connect the power source to the DC Power Input located underneath the unit.



Step-by-step Procedure:

1. Set up the tripod and tribrach over the point chosen for the base.
2. Screw the ProMark 800 on top of the pole.
3. Insert the antenna pole into the tribrach.
4. Perform a slant height measurement. Keep the measured value in your mind or write it down.

Rover Setup

This setup is intended for rovers having to run continuous or stop&go kinematic surveys.

Prerequisites:

- Use a range pole fitted with a 5/8" male adaptor at the upper end (not provided).



Step-by-step Procedure:

1. Screw the ProMark 800 on top of the range pole.
2. Perform a vertical height measurement, which consists in measuring the length of the range pole or reading the graduation on the pole. Keep the measured value in your mind or write it down.
3. Fasten the field terminal and its bracket further down on the pole so you can easily use the field terminal and read the information shown on the display screen.

Starting/Stopping Raw Data Logging

You simply need to use the Log button to start and stop raw data logging. Later, you will however need to do the following manually:

1. Downloading phase (if appropriate, rename the raw data files collected on each site).

2. Post-processing phase: Manually correct all computed elevations for the antenna height.

By default, raw data is logged to the receiver's internal memory. The Raw Data Logging icon on the General Status screen will start flashing when a raw data file is open for logging.

Downloading Raw Data

Use a USB mass storage device as a transit storage medium to download raw data files from the receiver's internal memory to your office computer.

Important! During a download operation, files are not deleted from the receiver but simply copied to the USB mass storage device.

After downloading the files to this device, connect the USB device to your computer and use your usual browser to copy the files to the project folder.

Using a USB Mass Storage Device

- Connect the USB mass storage device to the receiver via the short USB Host-to-Device cable provided (P/N 702104).

If raw data files are present in the receiver's internal memory, the following icons will automatically appear on the display screen:



- To confirm the file transfer, press the Log button. The General status screen will re-appear after the file transfer is complete.
- To cancel the file transfer, press the Scroll button.
- If you do not press any button within the next 10 seconds, the download procedure will be canceled automatically and the screen will come back to the previous display.

Using the USB Cable Provided

- Connect the USB cable provided (P/N 702103) between the office computer and the receiver's USB port. The

receiver is then seen as a USB device from the office computer

- Using Windows Explorer on your office computer, browse the receiver's internal memory for the raw data files.
- Copy/paste the files to your project folder. Note that raw data files can directly be deleted from the receiver's internal memory through this connection.



Chapter 4. Precise Surveying - Field Applications & Concepts



Introduction to Precise Surveying

GNSS precise surveying relies on the use of specific algorithms involved in the processing of carrier phase measurements. Centimeter precision obtained in precise surveying results from the successful processing of these measurements.

Carrier phase measurements are derived from the signals the surveying equipment receives and decodes from the visible GNSS constellations.

There are two different ways of implementing the processing algorithms, each of them defining a specific family of surveying methods:

- *RTK* real-time surveying.
- *Post-processed* surveying

This chapter introduces the basics of the two surveying families.

Note that Ashtech RTK-capable receivers can also be used for post-processed surveys, either simultaneously with RTK or as post-processed only. With these receivers, post-processed surveying can be used either as a backup method or as an excellent source of comparison for checking your real-time survey results.

Key Terms and Expressions

Carrier: Refers to the electromagnetic wave carrying signals transmitted by satellites (cf. L1 and L2 carriers).

Carrier phase measurements: Refers to measurements performed by a receiver from the received signals to determine the fractional phase of the carrier at the receiver location. This fractional phase is then added to the integer number of full carrier cycles between the receiver and the satellite, thus converting the carrier phase measurement into an extremely accurate range measurement.

CPD: Carrier-Phase Differential. An acronym that refers to the processing of reference carrier phase measurements for precise (RTK) differential measurements.

Fixed (solution): Status of the position solution once RTK operation is initialized and centimeter-level precision is achieved.

GNSS: Global Navigation Satellite System. GPS, GLONASS, SBAS and GALILEO are each a GNSS.

SBAS: Satellite Based Augmentation System. A wide-area or regional system composed of geostationary satellites providing GNSS augmentation, that is a method of improving locally the performance (i.e. accuracy, reliability, availability, etc.) of a GNSS. In addition, the SBAS satellites' carrier phase ranging data are used like any other GNSS satellite in Ashtech's BLADE –and more recently Z-BLADE– processing algorithms.

RTK Surveying

RTK (for *Real-Time Kinematic*) is a surveying method through which you ask the rover equipment to quasi-instantly determine the coordinates of your current location with centimeter precision.

This section describes the implementation rules common to all surveys performed with the RTK method and presents the three basic field applications:

- Logging points.
- Logging points in continuous mode (trajectory).
- Staking out.

Depending on the software application installed in the field terminal, more field functions may be available, for example for road construction or civil engineering. These additional functions are all enabled by the capability of the system to perform one of the three basic functions described in this section.

Key Terms and Expressions

Baseline: Distance between the base antenna phase center and the rover antenna phase center (see also *GNSS Antennas and Antenna Heights on page 62*). Fundamentally, the surveying system is used to determine all the components of the vector formed by the baseline.

Base/rover configuration: Refers to an RTK surveying system consisting of a base and a rover. As opposed to a rover-only configuration, this system is autonomous in the sense that

the surveyor has full control over the base data sent to the rover.

Constellation: Set of GNSS satellites visible from a given observation point on the Earth.

Data Link: A communication means allowing transfer of RTK correction data from a base to a rover.

Occupation Time: Time spent on a survey point without moving (“static” occupation) the antenna pole and keeping it vertical. Not relevant to logging points in continuous mode where each point recorded is a single epoch measurement.

Position Averaging: Process run in a rover during an occupation consisting of collecting all the position solutions delivered over this period and computing an average position from all these solutions. The resulting solution, which is statistically more accurate than each of the individual solutions from which it is derived, is assigned to the point on which the occupation took place.

Rover-Only Configuration: Refers to an RTK surveying system consisting only of a rover, which uses data from a third-party base or network to deliver centimeter-accurate positions.

RTK Correction Data or base data: Carrier phase differential data generated by a base allowing a rover processing this data to deliver centimeter-accurate positions.

TTF: Time To First Fix. The time required for an RTK system to get initialized, i.e. the time elapsed since power up before it can deliver a “fixed” RTK position.

Implementation Rules

1. Two systems are used: one (the base) is operated on a chosen point while the other (the rover) is used in the working area for the survey.
2. The base will be either:
 - A user-owned base fitted with a UHF radio, a GSM modem or any other suitable data link. To choose a reference location for the base, see *Choosing a Location for the Base on page 52*.
 - A third-party operated base (Direct IP) or base network (NTRIP) that delivers its data to the rover via a GSM/GPRS or CDMA modem.

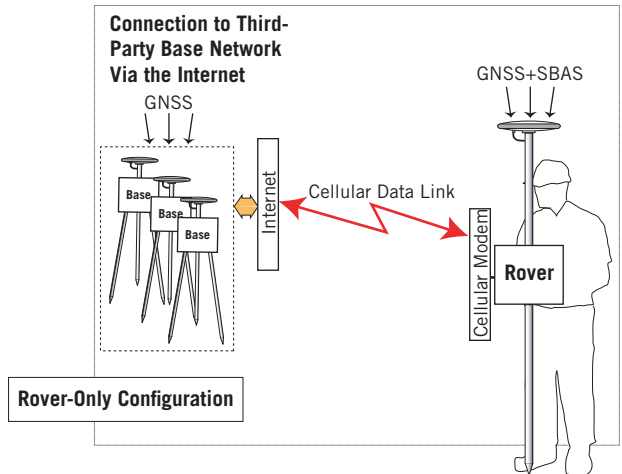
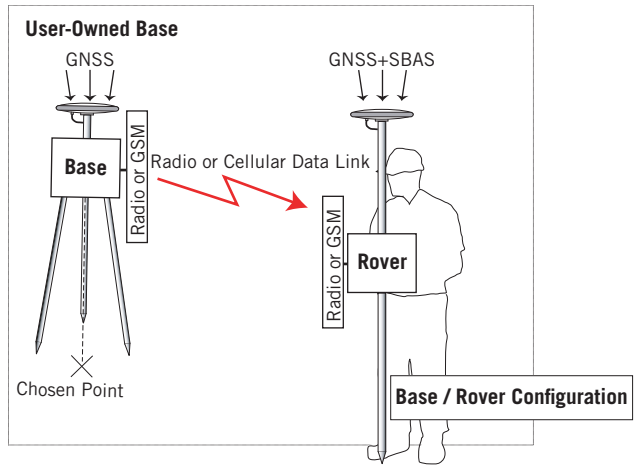

3. A data link must be established to transfer the base's RTK correction data to the rover. This data link can be implemented in several ways:
 - UHF radio
 - Cellular modem (GSM, GPRS or CDMA)
 - Other external device (e.g. Wi-Fi, spread-spectrum re-broadcast).
4. Successful surveying requires getting the system to be initialized and preserving initialization, or re-initializing if initialization is lost, throughout the survey. See *Initialization on page 115*.

5. There can be several rovers working together at the same time, receiving RTK correction data from the same base.

Logging Points Typical Use

Determining and logging the coordinates of points in a chosen coordinate system. The points are located within a relatively small area.

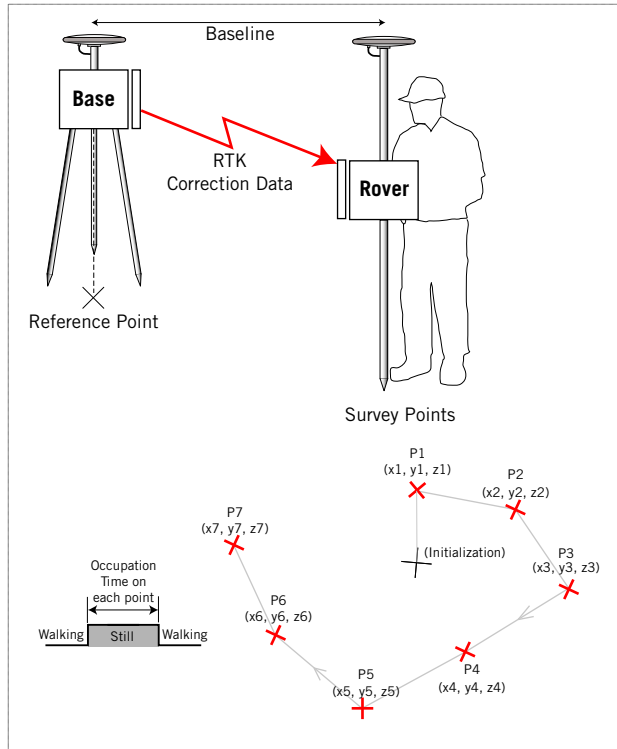

Key Points

- Make sure the rover delivers RTK positions before starting the job. (Initialization must be achieved and maintained.)
- Hold the antenna pole still and vertical over each survey point.
- Occupation time on each point is user-presetable. A countdown timer tells you when the receiver has finished logging the position of the point.
- During the countdown, the rover averages the successive positions it computes.

- With single-epoch measurements, the rover just logs the first position it computes on that point (no position averaging).

Logging Points in Continuous Mode

Typical Use

Determining and logging the coordinates of points along the line (trajectory) followed by the rover.

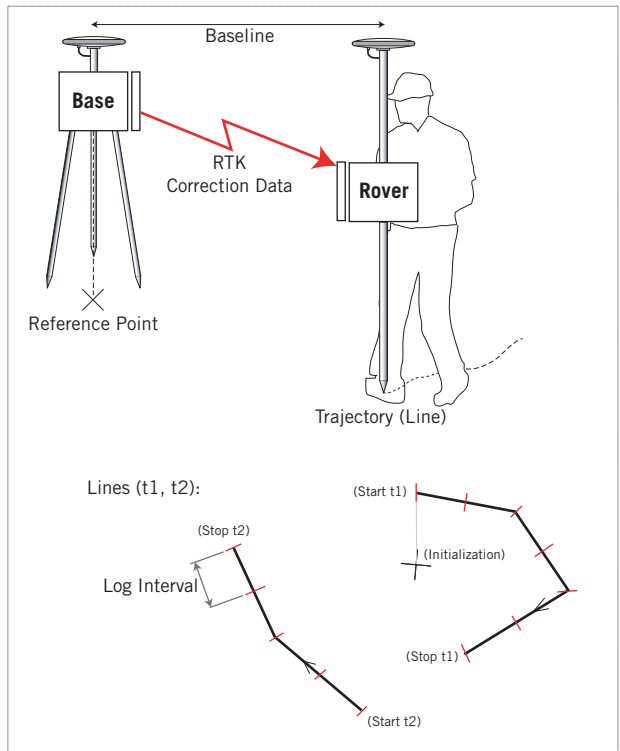

Key Points

- Make sure the rover delivers RTK positions before starting the job. (Initialization must be achieved and maintained.)
- Hold the antenna pole vertical all along the line.
- Points are automatically logged at regular intervals of time or distance. You set the log interval before starting the survey.
- Because you will be steadily moving along the surveyed trajectory, all logged points will necessarily be “one-shot” points, i.e. the first position solution available at the time

of point logging will be saved (no position averaging is possible in this case).

Staking Out Typical Use

Going to the field to accurately locate points, marking them with appropriate means and logging their positions, as determined by the rover. Stakeout points are typically a project's input data.

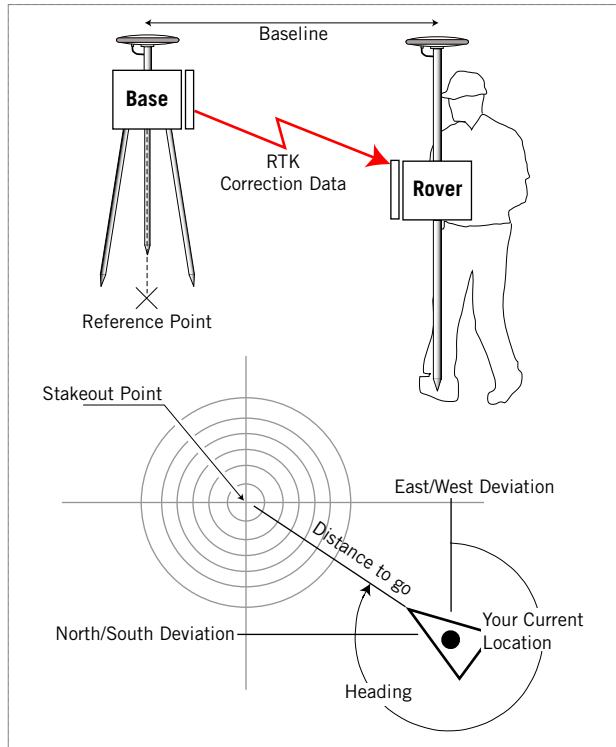

Key Points

- Make sure the rover delivers RTK positions before starting the job. (Initialization must be achieved and maintained.)
- You choose the point you want to go to from a list of points previously uploaded to your field terminal. The terminal screen will then guide you to the point.
- Hold the antenna pole vertical as you let your system guide you to the point. The screen switches to a more

accurate view as you approach the point. The system tells you when you are over the point.

- When you are over the point, mark its location on the ground. You can save the coordinates of the stakeout point with or without a position-averaging period.
- The rover will then automatically prompt you to move to the next point from the list and will guide you to this point.

Post-Processed Surveying

In post-processed surveying, the field equipment is only used to record *GPS/GNSS raw data* from which the post-processing software will be able to output centimeter-accurate positions.

This section describes the implementation rules common to all surveys performed with the post-processing method and presents the possible three field applications:

- Static survey.
- Stop & Go Kinematic survey.
- Continuous Kinematic survey.

Key Terms and Expressions

Baseline: Distance between the base antenna phase center and the rover antenna phase center (see also *GNSS Antennas and Antenna Heights on page 62*). Fundamentally, the surveying system is used to determine all the components of the vector formed by the baseline.

GPS/GNSS Raw Data or *Raw Data* for short: Data delivered by a GNSS receiver including code and carrier phase measurements and other satellite-related data such as almanacs and ephemerides.

Log Interval: Parameter used by some receivers in Continuous Kinematic survey to define the time elapsed, in seconds, or the distance traveled, in feet or meters, between any two successive markers inserted into the logged raw data file.

NOTE: Log Interval vs. Raw Data Recording Rate. The Log Interval should not be less than the Raw Data Recording Rate. For example, if Raw Data Recording Rate=1 second, then Log Interval should be at least 1 second (or 2 meters if for example your moving speed is 5 km/hr)

Observation Time: Time during which a base and rover simultaneously log GNSS raw data. The flow of collected data will be entirely usable if it is continuous from the start to end of the observation time.

Occupation Time: Time spent on a survey point without moving (“static” occupation). In static survey, Occupation

time= Observation time because only one point is surveyed.
Occupation time is irrelevant to Continuous Kinematic.

Raw Data Recording Rate: Interval, expressed in seconds, at which the field equipment records the raw data received from the GNSS constellation.

Implementation Rules

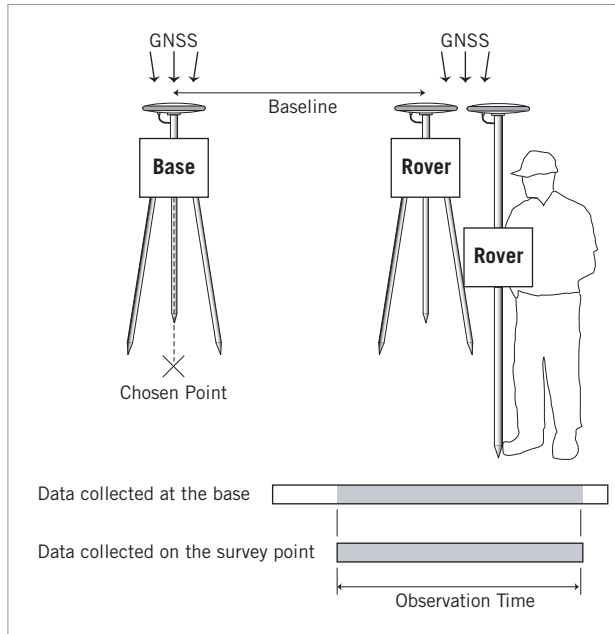

1. Two systems are used: one (the base) is operated on a chosen point while the other (the rover) is used in the working area for the survey.

The base may be either a user-owned base, in which case you need to properly locate your base (see *Choosing a Location for the Base on page 52*), or a third-party operated base.

With a third-party base, base data for your observation times can be downloaded through the Internet (cf. CORS) for post-processing. Rover data can also be uploaded to a centralized processing system (cf. OPUS or AutoGIPSY), which will in return provide centimeter-accurate position results.

2. Data must be collected simultaneously by the base and the rover. **It is best to use the same raw data recording rate on both units.**

3. Successful survey requires proper initialization of the system. See *Initialization on page 55*.
To maintain initialization throughout the survey, and especially in kinematic surveys, be careful at all times not to mask the rover's GNSS antenna.
For most Ashtech receivers, in case of poor reception or complete loss of satellite signals, a message will prompt you to resume initialization.
4. The common observation time is determined by the last unit set up (start) and the first unit turned off (end). It is advisable to start the base first and turn it off last.
5. The required observation time mainly depends on the baseline length, the reception conditions, the number of GNSS constellations and signal frequencies tracked by the receiver and the initialization method used. See *Initialization on page 55*.
6. Remember the rover will always collect data **continuously** throughout the survey, whether you are performing a static, continuous kinematic or Stop & Go kinematic survey. That is why you should continually keep the GNSS antenna clear of any obstructions.
If satellite lock is broken by obstructions, you will need to collect additional data after the tracking resumes before continuing. This data is used by the post-processing software to re-determine the ambiguities. The amount of data needed for re-initialization is the same as for the original initialization as discussed above.
7. There can be several rovers logging data at the same time.

Static Survey Typical Use

Surveying a New Control Point.

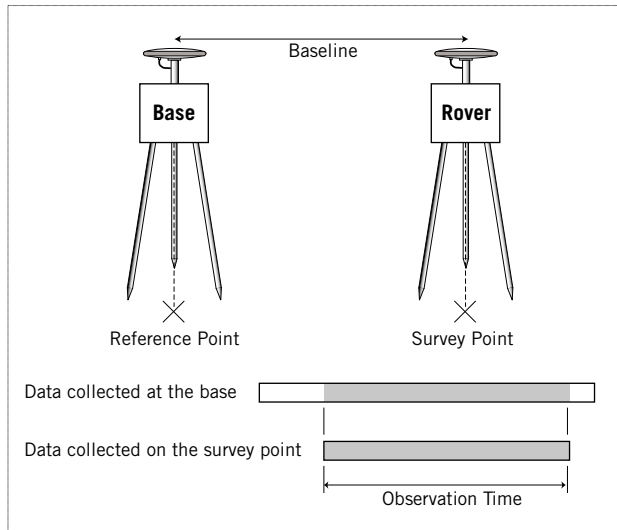

Key Points

1. Same system setup for the base and the rover.
2. The rover is stationary throughout the survey.
3. Occupation time=Observation time
4. Initialization and masking problems minimized as the rover is stationary.

“Stop & Go” Kinematic Survey

Typical Use

Surveying Several Points within a Relatively Small Area.

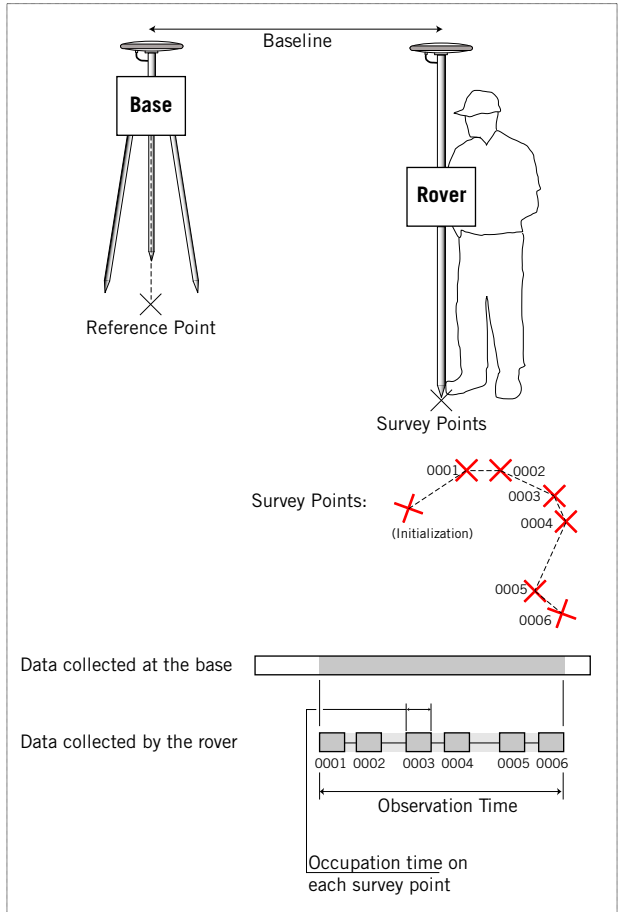

Key Points

1. The rover is moved successively onto each of the survey points. The rover antenna pole should be kept still and vertical over each survey point for a given occupation time.
2. Occupation time on each surveyed point is user-preset. A countdown timer tells you when to move to the next point.
3. In the rover, “surveying a point” in Stop & Go mode simply consists of inserting start and end markers into the logged raw data file. Each point is in fact delimited in the raw data file by a pair of start and end markers.

4. Points are automatically named (numeral suffix automatically incremented) unless you wish to give a particular name for each point.
5. Occupation time in fact defines the period of time for which the post-processing software will average the successive positions over this period of time. The resulting averaged position will be assigned to the point.

Continuous Kinematic Survey

Typical Use

Surveying Lines (Trajectories).

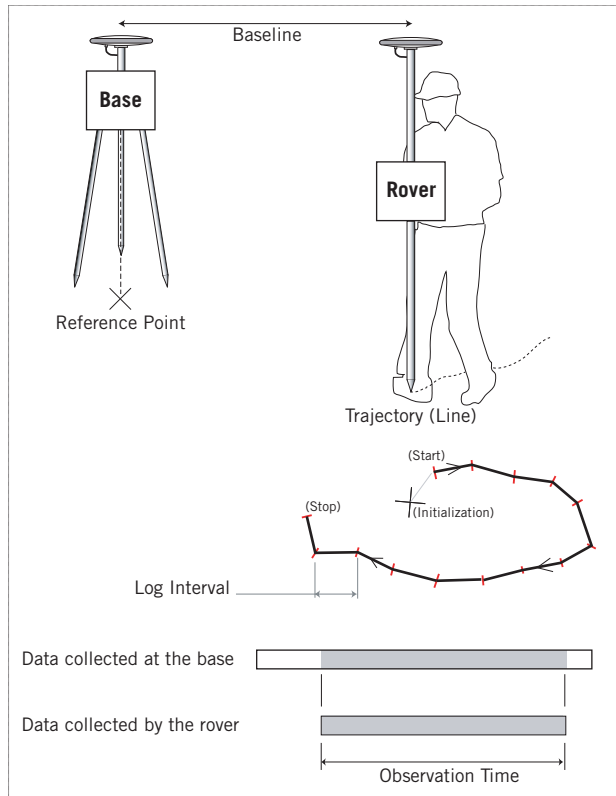

Key Points

1. The rover is moved along the line while raw data is being logged. The rover antenna pole should be held continually vertical throughout the observation.

2. Contrary to Stop & Go survey, there is no occupation time on a particular point. Data logging should be started at the beginning of the line and stopped at the end.
3. *Log interval.* With some field software applications, such as FAST Survey, the log interval can only be equal to the raw data recording rate, meaning that the line is necessarily surveyed in time mode.

With some others, more dedicated to post-processed surveys (such as ProMark Field), the log interval is distinct from the raw data recording rate. With this field application, you can log your lines either in distance or time mode and you set the log interval independently.

In distance mode, a new marker is created every x meters. In time mode, a new marker is created every x seconds, where " x " is the log interval.

While you are moving along the line, the rover inserts new markers into the logged raw data file according to the chosen log interval. Each marker is named as a point. The name includes a numeral suffix that is automatically incremented for each new logged marker. You must take care however to use a log interval that is compatible with the raw data recording rate:

In time mode:

log interval (s) $> 2 \times$ raw data recording rate (s)

In distance mode:

log interval (m) $> 2 \times$ moving speed (m/s) \times raw data recording rate (s)

4. *Number of lines in a single file.* Some field applications, such as FAST Survey, allow you to log a single line into a raw data file. Some others, like ProMark Field, allow you to enter several start/stop markers in the same file meaning that several lines can be logged in the same file.

Choosing a Location for the Base

The location of the base is fundamental for the success of your survey. Whether you are in post-processing or real-time mode and your receivers are single-, dual- or multi-frequency, remember the rover position will always be computed relative to the base position. Any inaccuracy in the base position will inevitably be transferred to the position computed by the rover.

When using base data from a third-party reference station or from a network of reference stations, making sure the base has been properly installed is not your responsibility. On the

contrary, if you are using your own base, it is essential that you install it according to the rules.

This section discusses the two basic criteria to be taken into account when installing your own base:

1. GNSS reception conditions
2. Base position known or unknown?

When a base radio is used, there is a third criterion to be taken into account in the choice of the base location, which is the ability to install the radio antenna as high as possible, with a minimum of obstructions to the working area, so that the radio range can be as long as possible.

First Criterion: GNSS Reception Conditions

Make sure the base is sited in a clear area giving the best possible view of the sky.

When possible, avoid trees, buildings or any high obstacles in the vicinity of the base.

Having a clear view of the sky will allow the base to collect data from a maximum of visible satellites, which is highly recommended to perform a successful, accurate and fast survey.

You should pay attention to low-level satellite signals coming through trees, which may have a more adverse effect upon system performance than those completely masked.

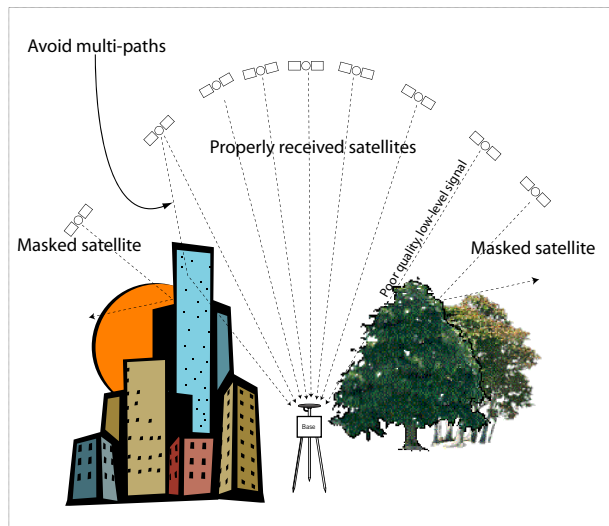

Second Criterion: Base Position Known or Unknown?

In addition to the good reception conditions required at the base, you must also think about whether the base position should be known with great precision or not. The explanations below will help you understand what you need in terms of base position accuracy.

1. **If you want to obtain absolute, centimeter-accurate positions** attached to a particular coordinate system for all your surveyed points, then the base position must be known with the same centimeter accuracy in the same coordinate system.

If the chosen position for the base is unknown whereas you need centimeter accuracy for this point in the coordinate system used, you can determine it through a static post-processing survey. You will however need a reference position to determine this point.

2. **If you are only interested in performing relative measurements** (i.e. positions of points relatively to other points), then the base can be installed on an unknown point meeting the reception requirements. In this case, the position to be entered in the base can be accurate only to within a few meters.

Caution! In this case, keep in mind that you will not be able to attach your points to a known coordinate system unless later you accurately determine one of these points in the desired coordinate system. With some field software, such as FAST Survey, you can also use the Localization function to attach your job to a local coordinate system.

There are some disadvantages that you should be aware of when installing a base on an unknown point. For every 15 meters of error between the estimated base coordinates and the true base coordinates, one part-per-million (ppm) of relative error will be introduced into the computed vector between base and rover, plus the absolute difference between the computed base position and the real base position.

For example, assume that the coordinates assigned to the base point are 30 meters off the true base position. This 30-meter offset from truth will produce 2 ppm (0.002 m per kilometer or 0.010 ft per mile) of error in the vector between base and rover.

If the rover is 5 kilometers (3 miles) from the base, this will produce 0.010 m (0.030 ft) of error in the vector. In most cases, the base receiver will estimate its position to

better than 30 meters (probably closer to 10-20 meters), but an error of 50 meters is possible.

If you plan to use an estimated position for the base, keep the vector lengths between the base and rover short and ensure the added error is not significant for the survey you are performing.

Initialization

Preamble

Initialization (also known as “ambiguity fixing”, “integer fixing” or just “fixing”) is the process through which your real-time receiver or post-processing software can solve the integer ambiguity inherent in the carrier phase processing. Solving for the integer ambiguities is a prerequisite for the receiver or software to be able to deliver centimeter-accurate positions.

For this reason, initialization is a requirement you should constantly keep in mind.

NOTE: This initialization process should not be confused with the initialization of a GNSS receiver, corresponding to the start sequence during which the receiver searches for the visible satellites in order to be able to compute its first standalone 5- to 10-meter-accurate position.

Importance of Baseline Length

The amount of data required to fix ambiguities in the software (post-processing) or the rover (RTK real-time) is proportional to the baseline length.

In other words, the longer the baseline length, the longer the time required to achieve initialization.

Key Terms and Expressions

DOP: Dilution of Precision. A factor computed by the equipment that describes satellite distribution in space. The lower the DOP, the better the distribution in space and the better the probability of a successful survey. Several DOP values exist, such as the GDOP, HDOP, VDOP, TDOP, but the most frequently used one is the PDOP (for Position Dilution of Precision).

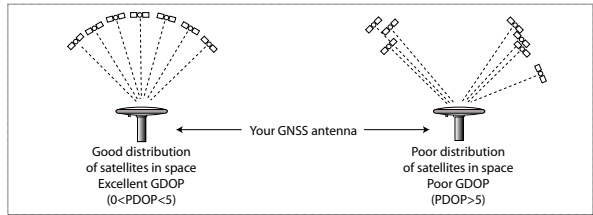

Integer Ambiguity: “Integer” refers to the number of entire wavelengths of signal carrier separating a satellite from a receiver. “Ambiguity” refers to the fact that this number is unknown at the beginning of a survey. Solving integer ambiguity therefore means determining the exact number of entire wavelengths.

Other General Considerations

RTK Real-Time vs. Post-Processing

In real-time surveys, system initialization is achieved when the system has been able to fix an RTK solution for any new position it computes. You just have to make sure this operating status is maintained until the end of the survey. In real time, it is therefore quite natural that you make sure the initialization process has been successful. Should you lose the “RTK” position status, then the system has lost initialization and you should act to restore it.

In post-processed surveys, there is the same need for initialization except that the system is not always able to inform you, in real time, that this requirement is met. Remember that in this type of survey, your system is just a raw data collector.

It is only subsequently, when back at the office to post-process the raw data that you will see if the complete set of collected data results in successful and sustained initialization.

Kinematic vs. Static

In static surveys, the risk of unsuccessful initialization is significantly lessened by the fact that the GNSS antenna is motionless and the system is operated for relatively long recording sessions with the best possible view of the sky. This may not be true for kinematic surveys during which the rover is moved from place to place, with real risks of:

- Masking the GNSS antenna causing lock on satellites to be lost.

- Stopping recording sessions before enough data has been collected to guarantee initialization.

For this reason, you should be aware of the initialization issue and so take all the necessary steps to make sure initialization will not only be achieved but also preserved until the end of your kinematic surveys.

Single-Frequency vs. Multi-Frequency

GNSS multi-frequency receivers need less data and time to get initialized. However, recent developments have allowed single-frequency receivers to significantly improve their performance on that particular point and so to reduce the gap that separates them from multi-frequency systems.

Strategies for Securing Initialization

When starting a survey, you will sometimes be asked to choose an initialization method (more particularly if you are using a single-frequency receiver). The selected method tells the system how it should deal with initialization. Some of these methods can make initialization easier and faster, resulting in the following:

- Reduction of the observation time in post-processing.
- Reduction of the TTFF in RTK.

This section describes the different initialization methods available with Ashtech receivers:

- Kinematic OTF
- Static OTF (for RTK surveying only)
- Known Point
- Initializer Bar

OTF and “Known Point” Methods

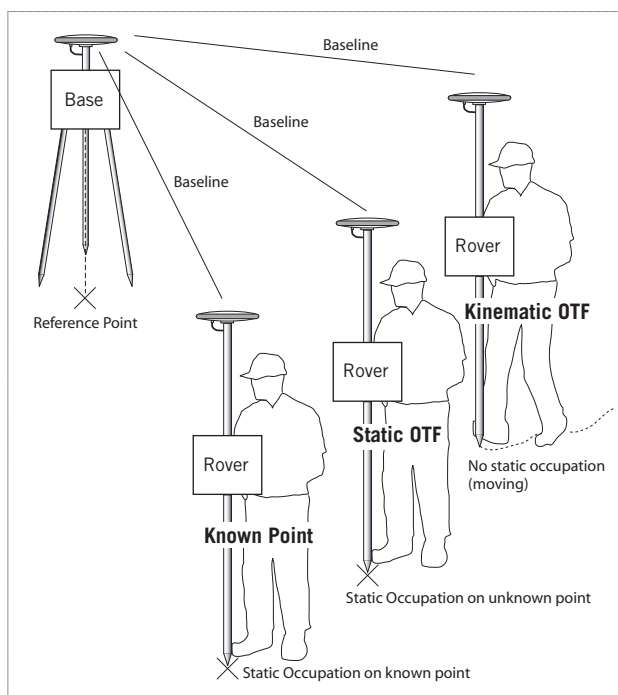

Kinematic OTF. For both post-processing and RTK real-time, this method does not make initialization faster but is the less constraining method in the field (although it does not release you from being careful on the operating conditions). Kinematic OTF should be used by default when there is no reference in the working area that can help secure the initialization.

Static OTF. An initialization method usable in RTK surveying only. The rover asks you to stay still on an unknown point until initialization is achieved (i.e. RTK position fixed). The declared static occupation time helps the rover initialize more quickly.

Known Point. In RTK surveying, the rover asks you to stay still on a known point until initialization is achieved (i.e. RTK position fixed). The declared static occupation time helps the rover initialize more quickly. This is a statistically faster initialization method than Static OTF for a given baseline length in the same reception conditions.

In post-processed surveying, the rover asks you to stay still on the known point for a preset occupation time. This particular event in the logged raw data file will help the post-processing software initialize more quickly.

The known point can be a point previously surveyed in post-processing static mode.

Initializer Bar

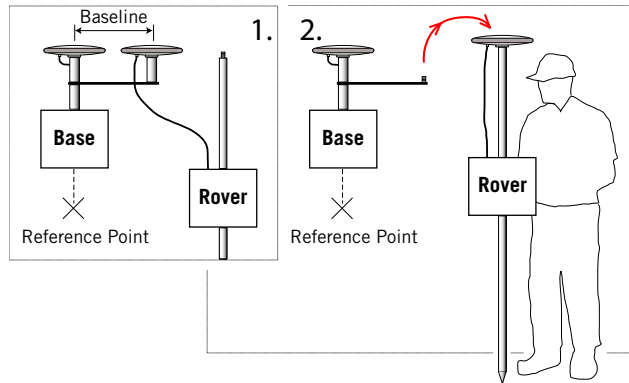

The Initializer Bar method can be used more especially when the survey takes place in the vicinity of the base (short baseline). It makes use of an initializer bar, also called “kinematic bar”, mounted at the base. The bar is attached to the antenna base and, for a limited time, the rover antenna as well.

The bar in fact defines a 20-centimeter, known baseline length. After a preset occupation time, the rover antenna is moved to the rover pole, taking care not to obstruct the antenna during this action.

Initialization in Field Approach RTK Surveying

In real-time surveys, the position status will at all times inform you of the real status of initialization. At power up, the time required to get a fixed solution, i.e. the time for the rover to get initialized is called TTFF (Time To First Fix).

Obviously, for a given baseline length, the better the operating conditions (low DOP, large number of received satellites, open sky conditions), the easier the initialization, and therefore the shorter the TTFF.

The initialization can even be faster if there is a possibility for you to use the “Known Point” initialization method, or, if your receiver is a ProMark3, the “Initializer Bar” method.

Typical Initialization Times (TTFF)

The charts below show the variations of the TTFF obtained with Ashtech receivers, as a function of baseline length, initialization method and receiver type, for normal operating conditions (open sky, 8 satellites, PDOP<3).

TTFF Charts:

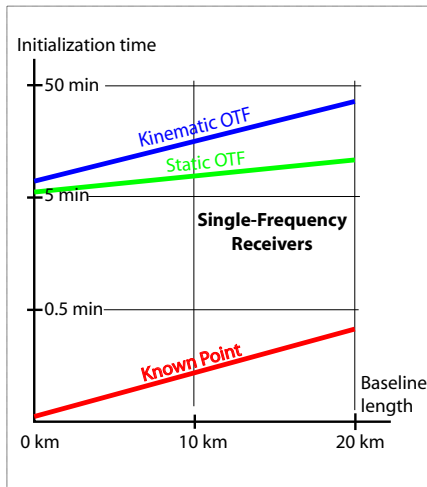
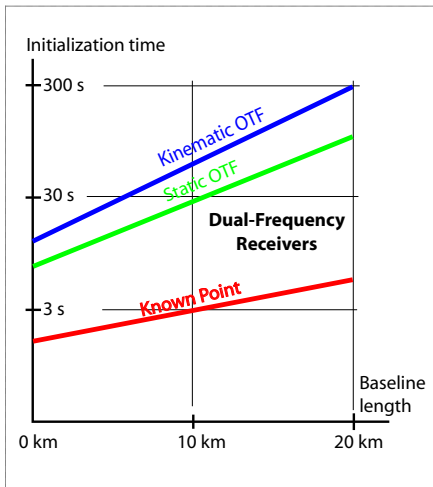

For single-frequency receivers using the initializer bar (baseline length: 20 cm), the TTFF is less than 60 seconds when one or more SBAS satellites are in view and their collection data are available.

Initialization in Post-Processed Surveys

Field Approach

In post-processed surveys, determining if the collected data will result in successful initialization when later post-processing the raw data is not as easy as in RTK. Below are a few recommendations to help you perform successful initializations:

- The observation time is an important factor for successful initialization. The longer the baseline length, the larger the required amount of data and so the longer the required observation time. Such indicators as the “Observation Timer” or “Observation Range” available on some Ashtech

receivers will help you take a decision on when to stop data collection.

- The lower the DOP, the larger the number of received satellites and the more open the sky, the better the chances for successful initialization. Such indicators as DOP, number of satellites received, sky quality (presence/absence of obstructions) will indirectly help you get a good idea of whether initialization will be achieved or not. Interpreting these environmental parameters will be easier as you become an experimented operator.
- In kinematic surveys, it is a good practice to deal with initialization at the beginning of a survey and then make sure you won't lose it until the end of the survey. However, you should be aware that, whether you are performing a kinematic or static survey and regardless of the method used to help secure initialization, the only thing that counts for a successful initialization is **the amount, quality and continuity of the collected data**. This means that **all** the logged data, and not only those logged at the beginning of the survey, can contribute to successful initialization.
- Choose the initialization method that is most appropriate to your survey. The Initializer Bar method (for ProMark3 users) and the "Known Point" method are preferred whenever possible.

Required Observation Times

The charts below show the minimum observation times required with Ashtech receivers, as a function of baseline length, initialization method and receiver type for normal operating conditions (open sky, 8 satellites received, PDOP<3 and 1-second raw data recording rate).

Observation Time Charts:

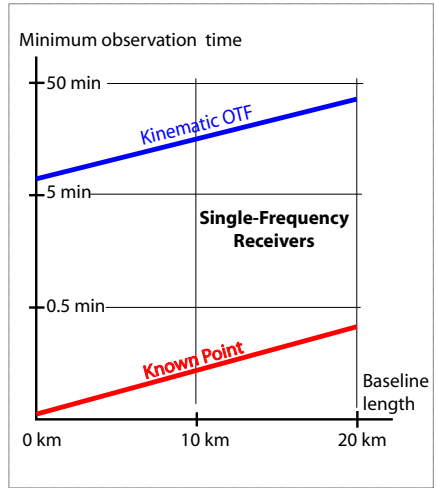
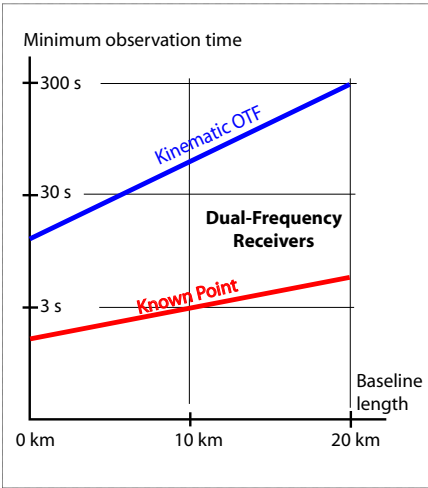

Not surprisingly, the minimum observation times in post-processed surveys are roughly equal to the TTFF's in real-time surveys, for the same type of equipment, baseline and initialization methods.

For single-frequency receivers using the initializer bar (baseline length: 20 cm), the minimum observation time is about 60 seconds when one or more SBAS satellites are in view and their collection data are available.

GNSS Antennas and Antenna Heights

GNSS Antenna Features

The figure below represents a generic GNSS antenna showing the features that are critical to precise surveying.

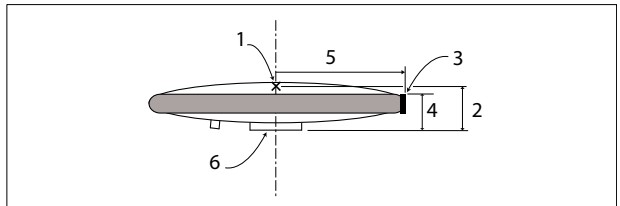

Phase Center Location (1)

This is a virtual point that represents the spatio-temporal origin of the antenna. It is usually inside the antenna and often on, or close to, the vertical axis of the antenna.

The phase center location is accurately determined by the antenna manufacturer or the United States National Geodetic Survey after a long series of tests. The location of the phase center is usually indicated on the antenna itself (see also 4. below).

A dual-frequency antenna usually has two different phase centers instead of one. In this case, the antenna manufacturer should mention the exact locations of the two phase centers.

Phase Center Offset (2)

Vertical distance that separates the phase center from the bottom of the antenna (see also ARP below).

SHMP (3)

(SHMP=Slant Height Measurement Point) Point located on the edge of the antenna radome into which a tape measure can be inserted to perform a slant measurement.

SHMP Offset (4)

Vertical distance that separates the SHMP from the base of the antenna. This parameter is needed by the system to determine the real height of the antenna over the landmark after a slant measurement has been entered into the system.

Antenna Radius (5)

Horizontal distance from the geometrical center to the edge of the antenna. This parameter is needed by the system to determine the real height of the antenna over the landmark after a slant measurement has been entered into the system.

ARP (6)

Antenna Reference Point located at the bottom of the antenna receiving the 5/8" adaptor of the antenna pole.

**Why is GNSS
Antenna Height so
Important**

The basic measurement giving centimeter accuracy is the vector from the phase center of the base antenna to the phase center of the rover antenna. Usually, the real position of interest is not the phase center of the antenna, but the survey mark (or other landmark) over which the antenna is set up.

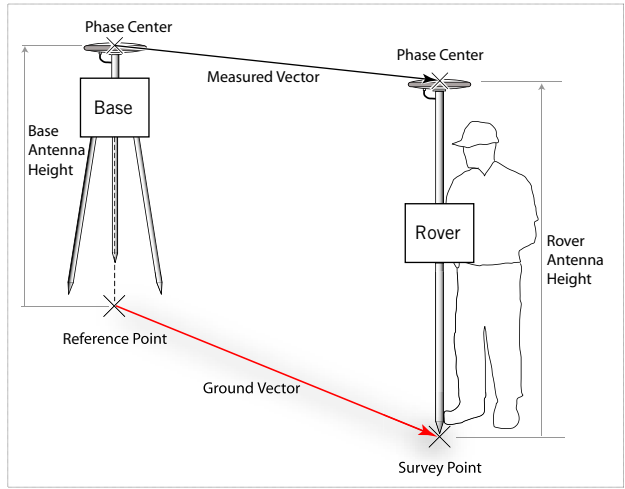

To compute the position of the mark instead of the antenna, it is necessary to instruct the rover to perform an *antenna reduction*. In an antenna reduction, the antenna heights are taken into account when computing the rover position.

Whether you are performing an RTK or post-processing survey, the antenna heights of both the base and the rover should be entered in the system so the correct ground positions can be determined.

There are two different ways of measuring the antenna height:

- Slant height measurement
- Vertical height measurement.

Slant Height Measurement

Slant measurement is typically performed at the base because the classical vertical measurement is not possible owing to accessories (tripod, tribrach, etc.) being usually in the way of the vertical path from the antenna to the landmark. Rather than performing a bad vertical measurement, it is a better idea to use a slant measurement, which is much more accurate, provided the antenna parameters are also accurately known and the specific Ashtech measurement tape is used for this purpose.

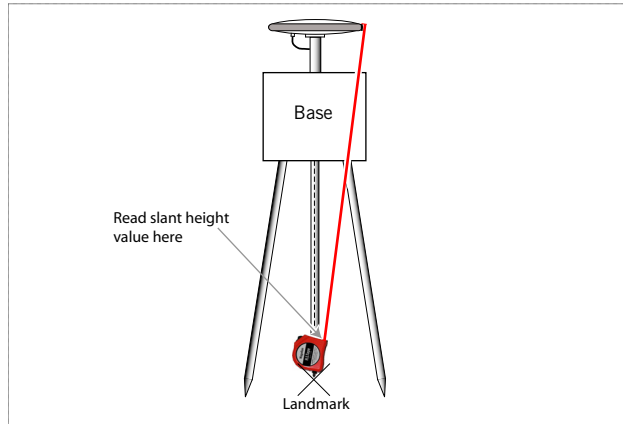

- Position the base system exactly over the landmark.
- Insert the end of the Ashtech measurement tape into the slot representing the SHMP.
- Unroll the tape toward the landmark and position the tip of the measurement tape onto the landmark.
- Block the tape and read the value indicated by the measurement tape: this is the slant height.
- Enter this value into the base system as a slant measurement.

If an Ashtech antenna is used, the system will automatically determine the true antenna height because it has got all the antenna parameters in its memory to perform the conversion.

For another antenna however, you will first have to create a new antenna type in the system and enter its parameters (see *GNSS Antenna Features on page 62*) in order to be sure the system can accurately convert the slant measurement into real height.

Vertical Height Measurement

This is a more straightforward method for measuring the antenna height. It is generally used on the rover side.

The vertical height represents the distance from the bottom of the GNSS antenna to the ground.

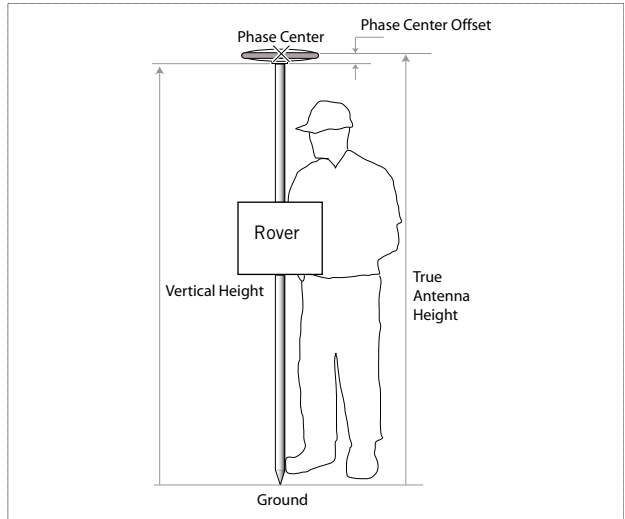

The real height of the antenna is therefore the sum of the vertical height and the phase center offset.

Measuring the vertical height only consists in measuring the length of the range pole used to support the GNSS antenna and the rover unit. As most range poles are height-adjustable and have a graduation to set this height, measuring the vertical height only consists in reading the graduation on the pole.

If an Ashtech antenna is used, the system will automatically determine the true antenna height because it has got all the antenna parameters in its memory to perform the conversion. For another antenna however, you will first have to create a new antenna type in the system and enter its parameters (see *GNSS Antenna Features on page 62*) in order to be sure the system can accurately convert the vertical measurement into real height.

Using a Virtual Antenna

What is the Problem?

Not all the GNSS antennas available on the market are known to all hardware manufacturers and software editors.

Now, when post-processing raw data files, this is a problem because these files hold the names of the GNSS antennas that were used for data collection. From these names, the software is supposed to retrieve the essential dimensional parameters of these antennas (phase center offsets, SHMP offset, radius, ARP). These dimensions are essential if you want the post-processing to deliver the best possible accuracy for all your points.

Something goes wrong in the post-processing when the header of a raw data file refers to what is an unknown antenna name for your software.

And what if instead, a universal antenna name was mentioned in the file that would prevent your software from being stalled? That's where the concept of virtual antenna comes into play. A virtual antenna is an antenna whose characteristics are known to a maximum of actors in the surveying community

So the purpose of substituting the name of the real antenna for the name of a virtual antenna is to make sure the raw data file will always be recognizable and "processable", whatever the post-processing software used. Using a virtual antenna is like making your raw data files virtually "universal", by disconnecting them from the surveying equipment that collected them.

But this is no minor change for the receiver, as explained below.

What the Receiver Has to Do to Support a Virtual Antenna

Using a virtual antenna means moving the spatial point for which data collection actually takes place from the real antenna phase center to the virtual antenna phase center (and there are as many phase centers as there are frequencies that the antenna can receive).

The diagram below shows an example of real and virtual phase centers for one of these frequencies.

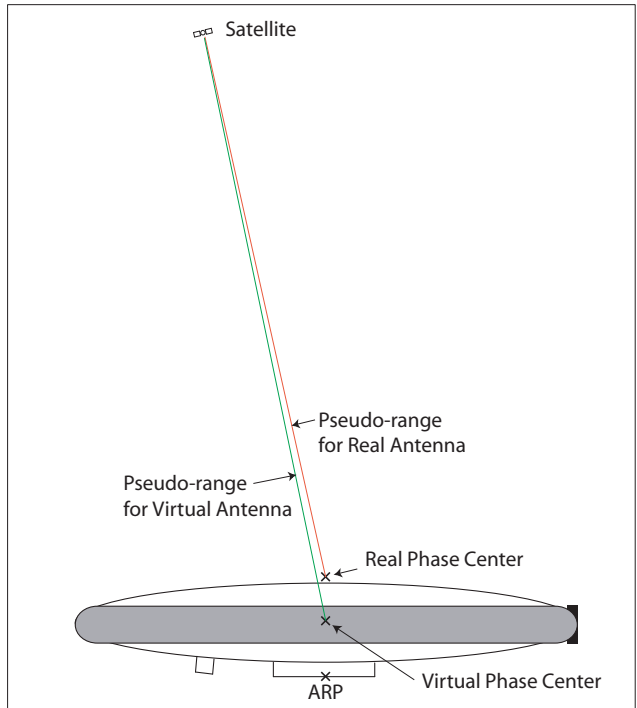

The receiver has to correct the collected data (most notably pseudo-ranges) so that they appear as if they had been collected –for each frequency– at the virtual phase center, not at the real phase center.

This implies for the receiver to be informed of the dimensional parameters of the real antenna used, and the necessity for it to perform the correction automatically on the raw data being collected after the “Virtual antenna” function has been enabled.

Note that in the data conversion, the virtual ARP is maintained at the same location as the real ARP.

When GNSS antennas are embedded in the receiver (active antennas such as ProMark 500 or ProMark 800), users don't have to enter their characteristics (because they are hard coded in the receiver).

On the other hand, when an external antenna is used, with the ProFlex series or with ProMark 100 or 200 for example, users have to specify which external antenna is used so the receiver can perform the appropriate correction.

About The Different Virtual Antennas Existing Today

There exists different virtual antennas, with different names and specifications. However behind all these antennas is the same function assigned to the receiver, which is to correct the raw data for the point(s) of data collection defined for the virtual antenna.

One of the most widely used virtual antennas is the “ADVNULLANTENNA” antenna. Most Ashtech products implicitly select this antenna when the virtual antenna function is enabled. However other virtual antennas may be selected, requiring the use of a few proprietary serial commands (\$PASH).

NOTE: You are right if you think only one virtual antenna should have been defined worldwide. Unfortunately this is not the case. Probably several initiatives were started at the same time for the same purpose, giving rise to several antenna names and specifications.

Cases of Use

As seen above using a “virtual” antenna makes sense when having to collect raw data. It also makes sense in RTK surveying because rovers need to know the type of GNSS antenna the base uses to generate its corrections.

Using a virtual antenna is recommended in the following cases:

- You are working with surveying equipment and software from different manufacturers.
- You are producing raw data files that you share with a lot of other people from other companies
- You are providing base raw data or RTK corrections to a large number of users who do not necessarily use surveying equipment from the same manufacturer.

Ellipsoidal Height and Elevation

The vertical coordinate measured by GNSS systems is worth an explanation. Behind this coordinate in fact lies the specificity of GNSS systems compared to conventional surveying systems.

Basically, all positions delivered by GNSS systems consist of *geographic coordinates* (latitude, longitude, height) referenced to an ellipsoid, called *reference ellipsoid*, which is a simple and accurate model to describe the shape and surface of our planet.

The reference ellipsoid refers to the WGS84, or better the ITRFxx, where xx is the year the ITRF was realized (e.g. ITRF00 was realized in the year 2000).

The center of this reference ellipsoid coincides with the center of the mass of the Earth, which is also the origin point of the Earth-Centered Earth-Fixed (ECEF) X, Y, Z Cartesian coordinate system.

As far as horizontal coordinates are concerned, the reference ellipsoid gives full satisfaction. Converting geographic coordinates to any projection system does not raise any particular problem.

Things are a bit more complicated though when dealing with vertical coordinates because surveyors need to define very precisely which type of vertical coordinates they wish to measure.

The vertical coordinate provided by GNSS systems basically is the height of the surveyed point over the reference ellipsoid. We call it the *ellipsoidal height*.

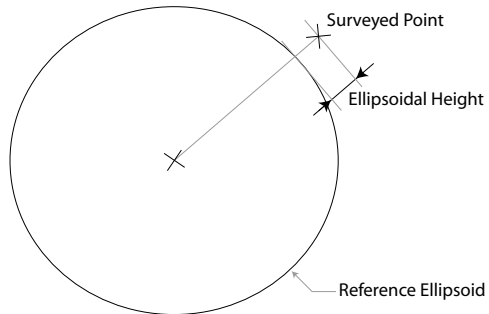

For a long time, surveyors have used the concept of “mean sea level” to measure the *elevations* of their points. The mean sea level was the common “zero” elevation. But this concept has shown some limitations.

Today, a much better model of vertical reference system, called *geoid*, is used. This model is defined as a surface on which the pull of gravity is constant.

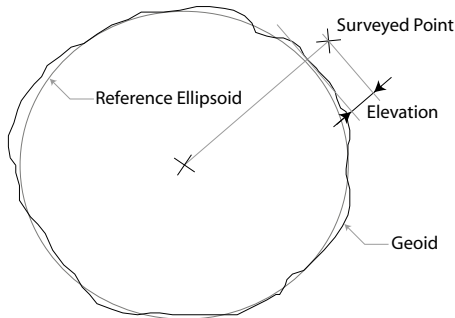

This surface is irregular depending on the density and distribution of materials on the surface of the Earth, which means the geoid may not exactly follow the natural features on the Earth's surface. (The geoid is a fictitious surface that can't be seen).

Sorry for being now a bit sarcastic, but using the geoid as vertical reference, one can be sure water will always flow downhill, from lower to higher gravity level, which was not always the case when using the too-approximative mean sea level!!

So the question is now, *"How can we convert an ellipsoidal height provided by our GNSS system into an elevation?"*

In practical terms, a geoid model used in a GNSS system is a file containing a more or less dense array of points evenly distributed across the surface of the geoid. For each point, the file provides the horizontal geographic coordinates and the separation (geoidal separation) between the reference ellipsoid and the geoid. The extent of the geoid file may be worldwide or limited to a particular area.

Providing an accurate modelling of the undulations of the geoid surface, the geoid file is used by the GNSS system to interpolate the separation between this surface and the surface of the reference ellipsoid for the point surveyed.

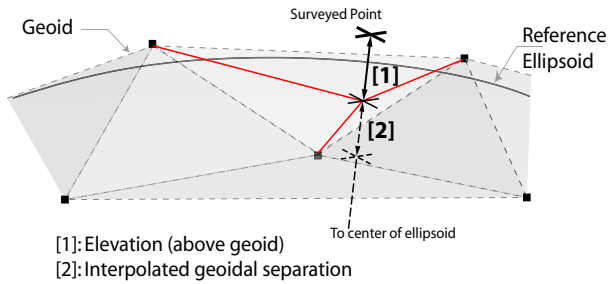

From this interpolation the system can derive elevation from ellipsoidal height using the following formula:

$$\text{Elevation [1]} = \text{Ellipsoidal Height} - \text{Interpolated geoidal separation}$$

General Considerations Regarding Accuracy

What Accuracy Mainly Depends On

In precise surveying, accuracy is primarily tied to the capacity of a system to detect the finest variation in the portion of carrier wavelength arriving at the surveyed point, assuming the number of complete carrier cycles has been determined successfully (cf. integer ambiguity in *Initialization on page 55*).

Knowing that the carrier wavelength of the L1 signal used in the processing is equal to 19 cm, this gives an idea of the processing step the system has to go through to achieve centimeter accuracy.

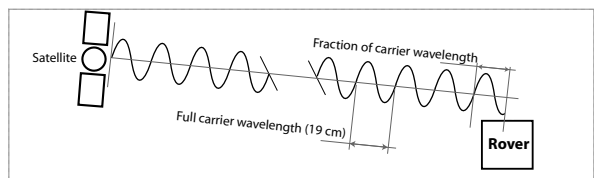

In practice, accuracy will first depend on the following parameters:

- Quality of the carrier phase measurements, i.e. quality of the receiver (noise level) and environmental conditions (number of received satellites, presence or absence of multipaths).
- Intrinsic quality of the processing algorithms used.

Accuracy will also depend on the RTK correction data received from the base:

- The further the distance between the surveyed point and the base, i.e. the longer the baseline length, the higher the theoretical uncertainty affecting the position result.
- The lower the reception level of the received RTK correction data, the less the data involved in the processing and the higher the measurement uncertainty affecting the position result.

Accuracy will also depend on whether the survey is run in real time (RTK) or post-processing. In post-processing, because the system processes all the collected raw data, accuracies are better than in real time, provided the observation times are long enough.

Expression of Accuracy

For all Ashtech precise surveying systems, the expression of the global accuracy on position is the sum of a constant term and a variable term, as expressed in the equation below.

$$Accuracy = X_{cm} + Y_{ppm}$$

Where:

- **X** is the constant term, in centimeters, indicating the global uncertainty on position measurements (an rms value, see *Accuracy Measures on page 74*). X qualifies the intrinsic quality of the receiver and its algorithms under nominal reception conditions (i.e. open sky, a minimum number of satellites is received and good GDOP). It may be different for the vertical and horizontal components of position.
- **Y** is the variable term, expressed in parts per million (ppm) of baseline length. For example, if Y=1 and the baseline length in your survey is about 8 km, then Y brings about an additional, and nominal, 8 millimeters uncertainty on all positions. The value of Y also reflects the quality of the receiver and the algorithms used. Like X, Y may be different for the vertical and horizontal components of position.

For your information, usual figures of accuracy for fixed RTK positions are given in the table below for nominal reception conditions (open sky, good GDOP, 5 to 7 satellites received). But remember these values are specific to each model.

Please refer to the specifications sheet of the model you are using for more information.

Accuracy (rms)	RTK	Post-Processing
Horizontal	1 cm + 1 ppm	0.5 cm + 1 ppm
Vertical	2 cm + 1 ppm	1 cm + 2 ppm

Obviously, accuracy figures deteriorate when the system fails to fix the position.

Accuracy Measures

Errors on coordinates determined with GNSS systems are not constant (the solution varies statistically).

If you plot the horizontal coordinates of a reference point (X_0 , Y_0) computed by a GNSS system over a significant period of time (static survey), you will obtain a scatter plot such as the one below.

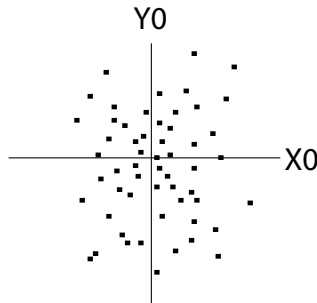

The origin of the (X_0 , Y_0) axis system is the true position of the reference point. Each dot represents a position solution delivered by the GNSS System for this point.

How you analyze the scatter of solutions results in a different accuracy figure characterizing the performance of the system.

The main accuracy measures used by GNSS manufacturers are the following:

1. *rms* (root mean square): accuracy is obtained by computing the square root of the average of the squared errors (a statistical method).
If error distribution along each axis is Gaussian (it is in general), i.e. the mean error converges to zero, or close to zero, then an error probability may be associated with the rms accuracy. This probability is about 68%, which means the computed position will be within the announced

accuracy about 68% of the time. This percentage corresponds to the 1-sigma width on the Gaussian curve.

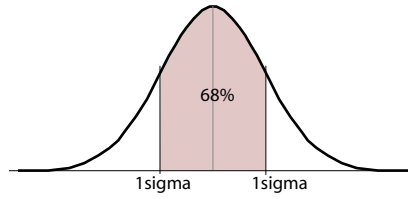

- Some manufacturers use the “2drms” measure, which is derived from the rms measure on the horizontal plane, using the following formula:

$$Accuracy(2drms) = 2 \times Accuracy(rms)$$

- CEP (Circular Error Probable): accuracy is equal to the circle's radius, centered at the true position, containing 50% of the points in the horizontal scatter plot (see chart below). This means the computed position will be within the announced accuracy 50% of the time.

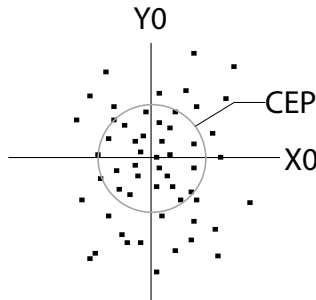

Localization

What is Localization?

Localization, also known as “calibration” or “determining the local grid”, consists of accurately determining a local grid that fits in with the job you want to perform. The localization process performs a rotation and translation of the plane defined by the projection system chosen for the job.

After localization has been run, your equipment provides the coordinates of every point, including new surveyed points, on this local grid.

Typically through localization, your equipment determines the new local grid (a plane) by comparing the known local coordinates of one or more reference points with the corresponding geographic coordinates entered or measured for these points.

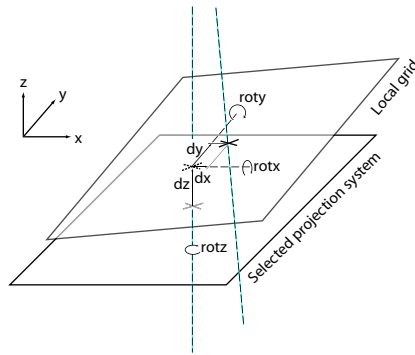

NOTICE: Not all the existing field software applications have the capability to run localization in real time. Ashtech FAST Survey and Spectra Precision Survey Pro are two of those applications that allow you to do that.

When is Localization Needed?

Performing localization is required in the following cases:

- Your job requires that a given standard projection be used but you realize that your equipment does not deliver exactly the expected coordinates when placed over existing reference points.
- Your job requires that a local projection be used but none of the parameters of this projection are known.
- The base is operated on a reference point whose position was only determined in autonomous GPS mode.

Localization Methods

Several localization methods exist. The choice of a method depends on the nature of the problem you have to solve and the number of available reference points. The most commonly used localization methods are listed below:

- *Plane Similarity*: In this method, the user should provide three or more reference points among which at least two of them should be held horizontally. A least-square transformation is performed to determine the local grid. The transformation includes rotation and translation of the plane defined by the standard projection system used, as well as scale factor change. The use of three reference

points or more is highly recommended to achieve accurate localization on the horizontal plane. This number should be raised up to four, or more, to ensure vertical localization.

- *Rigid Body*: Same as plane similarity except that the scale factor is held fixed throughout the localization process.
- *Helmert*: With this method, the user provides the seven parameters modifying the projection system currently used in the job. These parameters (dX, dY, dZ, rot X, rot Y, rot Z and scale factor) may be the result of a multi-point localization performed earlier.
- *One-Point Azimuth*: This method is used when only one reference point is available to determine the local grid. In this case, the user should specify the orientation of the North direction of the local grid (geographic or true). A typical application of this method is to use the point where the base is installed at the origin (0, 0, 0), or on a singular point (e.g. 100, 1000, 0) of the local grid. In this case, the geographic coordinates of the base position may feature only several meter accuracy since the surveyor is only interested in collecting local coordinates for the job. It will therefore be the surveyor's responsibility to make sure the geographic coordinates of the base (typically determined through the autonomous GPS mode) can be fed into the localization process.

A geoid model can be included in the localization process. In this case, all elevations provided for the reference points used should be orthometric instead of ellipsoidal.

Typical Instructions to Complete a Localization Process

Localization based on the use of reference points is typically achieved through the following steps:

1. Make sure the right projection system is selected in your job. What does that mean? Here are the two cases to consider:
 - Some reference points that you will hold horizontally or vertically fixed in the localization process may have their coordinates expressed in a known projection system. We recommend you select this projection as the job's initial projection system.
 - If the local coordinates of your reference points do not refer to any known projection system, then we recommend you choose a projection system that is standard in your working area.
2. Enter the local coordinates of the first reference point.

3. Enter the latitude, longitude and ellipsoidal height of the first reference point.
4. Set horizontal or/and vertical control for the first reference point. This means requiring that the local grid pass through respectively the horizontal or/and vertical position of the point.
5. Resume the previous three steps until all the reference points have been defined.
6. Run the localization process and make sure the local grid is now the new projection system used in the job.



Chapter 5. RTK Implementation



Data Link

In an RTK surveying system, the data link is used to transfer RTK correction data from the base to the rover.

The data link may be one of the following two types:

- *Standalone*: You will have full control over the generation and transmission of RTK correction data (Ashtech equipment used in base/rover configuration).
- *Network-based*: You will be resorting to a third-party, network-based provider for the generation and delivery of RTK correction data (Ashtech equipment used in rover-only configuration)

This section introduces the two basic transmission means available in Ashtech surveying systems for setting up this data link:

- Radio (standalone)
- Cellular mobile communications (cell phone, cellular modem).

For mobile communications, this section describes the different operating modes available:

- CSD (standalone)
- NTRIP (network-based)
- Direct IP (network-based).

Key Terms and Expressions

Age of Corrections: The age of corrections is measured as the time elapsed between the time corrections are generated in a base and the time when they are effectively used to yield an RTK position in a rover. Generally speaking, the quality of corrections decreases as their age increases.

CDMA: A standard for mobile communications based on CDMA (Code Division Multiple Access) technology. CDMA is mostly found in the United States, Canada, and North and South Korea.

CSD: Circuit Switched Data. CSD is the original form of data transmission developed for the Time Division Multiple Access (TDMA)-based mobile phone systems like GSM.

Direct IP: (IP=Internet Protocol). A way of acquiring base data from the Internet via a network connection to a static IP address.

GPRS: General Packet Radio Service. A mobile data service available to GSM modem users such as cell phone users. GPRS data transfer is typically charged per megabyte of transferred data, while data communication via traditional circuit switching is billed per minute of connection time, independent of whether the user has actually transferred data or has been in an idle state.

GSM: Global System for Mobile communications. A widespread standard for mobile communications based on TDMA (Time-Division Multiple Access) technology.

Modem: A device that modulates an analog carrier signal to encode digital information, and also demodulates such a carrier signal to decode the transmitted information.

NTRIP: Networked Transport of RTCM via Internet Protocol. A protocol used by GNSS service providers to deliver corrections from their networks of reference stations (bases).

NTRIP Caster: A piece of software in charge of collecting data from a network of Internet-connected bases using the NTRIP protocol and responding to a rover request by routing RTK correction data from the desired base to the calling rover. Rover requests are addressed to the caster via a network connection.

Source Table: Refers to a caster. The source table lists the characteristics of all the bases managed by the caster.

TCP/IP Direct: Designates a network connection in Direct IP mode that includes secure data exchange mechanism between the different units involved (about 90% of the connections available in Direct IP mode).

Transfer Rate: The interval at which a base is set to transmit its RTK correction data. Usually expressed in seconds.

UDP/IP Direct: Designates a network connection in Direct IP mode in which data exchange only relies on the use of IP addresses and port numbers (unlike TCP/IP Direct, there is no secured data exchange mechanism; about 10% of the available connections in Direct IP mode).

Radio Implementation

Radios are usually operated in pairs (one at the base, used as a transmitter, and the other in the rover, used as a receiver), but an unlimited number of rovers can receive RTK correction data from the same base.

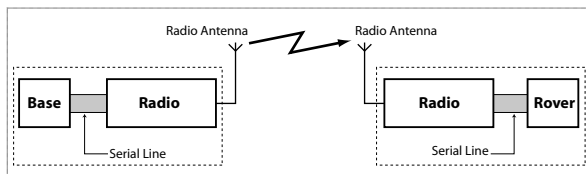

An important factor is the radio range. It should be equal to or greater than the maximum baseline length you need to survey.

Internal vs. External Radios

Depending on the model of Ashtech receiver used, the pair of radios can be:

- Incorporated into the Ashtech receiver. Only the radio antenna is visible from outside. The modem is connected to the system via a serial line.
- External to the Ashtech receiver and connected to it via a power/serial data cable.

License-Free vs. Non License-Free Radios

In almost all countries, radio systems are subject to laws regulating their use. Regulations are more especially about transmission power, frequency band and channel bandwidth. They may differ from one country to the other.

In most countries however, radios used under a certain level of radiated power in dedicated frequency bands do not require a certification (or license) to be operated freely. For this reason, Ashtech offers two types of radios:

- License-free, low-power radios (short range) (available for some models of Ashtech receivers).
- Licensed medium-power radios (longer range). For this type of equipment, Ashtech will help you get the certification required for use of the radio in your country. But remember the right to operate a radio is *your* responsibility.

Key Features

The main features of a radio are the following:

- UHF Frequency band: Range of UHF frequencies on which the radio transmits or receives data (license-free radios operate in the 850-930 MHz band, other radios in the 410-470 MHz band).
- Channel spacing or channel bandwidth: Space occupied by one channel (in kHz).
- Radiated power: Transmission power, in watts (W) radiated by the radio used at the base.
- Channel number: Corresponds to a specific carrier frequency within the band. In theory, the number of available channels is equal to the ratio between the whole frequency band and the one-channel bandwidth.
- Modulation type: A parameter that defines the technique used to modulate the carrier with RTK correction data (GMSK or FSK)
- Radio data rate: Speed at which the carrier frequency is modulated with RTK correction data. Expressed in kbits/second. Not to be confused with the baud rate of the serial line connecting the radio to the rest of the equipment.
- Frequency hopping (or Spread Spectrum): A process through which the radio regularly changes the carrier frequency. The radio usually loops on several preset channel numbers. In some countries, regulations exist that require the implementation of this technique.
- Duty Cycle: Ratio between the time period a radio is on (i.e. is transmitting) and a full cycle of radio on/off periods. In some countries, regulations exist to maintain this parameter under a certain threshold.
- Operation indicator: The ability for a radio to inform users in real time of the quality and strength of the signal transmitted or received.
- Forward Correction Error (FEC): Made available by some radio manufacturers. A function or process through which a radio system gives itself the capability to correct the data bits that are corrupted during the radio transmission. This process is based on the use of additional bits encoded at transmitter level, calculated from the real data bits that have to be transmitted. At receiver level, the bit streams are analyzed. Isolated bits may be found corrupted in which case they are brought back to their real value (1 instead of 0 or the other round). This process involves interleave techniques on both sides of the radio transmission.

As a rover user, you should make sure this function is also activated at the base before activating it in your radio receiver, otherwise the radio link won't work at all.

If you are using heterogeneous sets of radios (i.e. radio transmitters and receivers from different manufacturers), make sure this function is disabled in the radio receiver or transmitter where it is made available.

- Scrambling: Also made available by some radio manufacturers. A bit-encoding process intended to improve the overall performance of the radio transmission by better balancing the succession of "0's" and "1's" in the radio transmission channel. This is to avoid some malfunctioning that might appear when too many "0's" or "1's" are supposed to be transmitted in a row.

As a rover user, you should make sure this function is also activated at the base before activating it in your radio receiver, otherwise the radio link won't work at all.

If you are using heterogeneous sets of radios (i.e. radio transmitters and receivers from different manufacturers), make sure this function is disabled in the radio receiver or transmitter where it is made available.

Activating a Radio Data Link

Some radios are plug-and-play units, some others need a few preliminary settings (channel number, data rate + internal port settings).

Pros and Cons

With radios, you are usually independent of any third-party data provider. Your base can on its own generate and transfer RTK correction data via the radio. This is possible any time, from any place. In addition, several rovers can work in RTK from the same base (multi-point mode).

However, wave propagation in the UHF band is sometimes difficult. The radio range can dramatically be reduced if obstructions exist between the base and the rover. As a general rule, radio antennas should be raised as high as possible.

Cellular Mobile Communications

Implementation

Cellular modems or cell phones can be used for the data link in one of the following two configurations:

- A pair of modems operating in CSD mode. One is used at the base and the other at the rover. The data link operates like a phone link, the rover being the caller. This

configuration is well suited to surveying systems used in base/rover configuration.

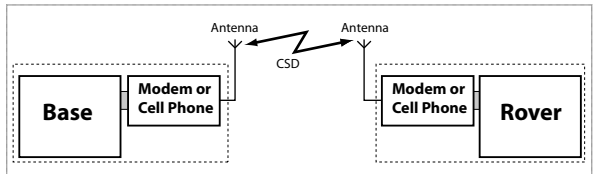

- One modem or cell phone operating in GPRS mode. The modem is used on the rover side to establish a connection to the Internet, either in Direct IP or NTRIP mode. The rover will then receive RTK correction data from the selected base. This type of data link is well suited to surveying systems used in rover-only configuration.

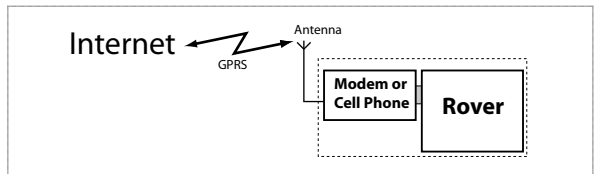

Internal vs. External Modems

Depending on the model of Ashtech receiver used, modems can be:

- Incorporated into the Ashtech receiver. Only the antenna is visible from outside.
- External to the Ashtech receiver and connected to it via a power/serial data cable or a Bluetooth connection.
- External to the Ashtech receiver and available as cell phones.

Features

GSM:

- Based on TDMA technology (TDMA= Time-Division Multiple Access). The frequency band is divided into multiple channels which are then stacked together into a single stream.
- Frequency bands used: 900MHz and 1,800 MHz in Europe and Asia, 850 MHz and 1,900 MHz in North America and Latin America.

CDMA:

- Based on CDMA technology (CDMA=Code Division Multiple Access) spreading data out over the channel after the channel is digitized. Multiple calls can then be overlaid on top of one another across the entire channel, with each assigned its own “sequence code” to keep the signal distinct.
- No specific frequency band per country.

Activating a Data Link in CSD Mode (GSM Only)

In this mode, you will have to:

- Make sure the base and its modem or cell phone have been set up properly, and are operating.
- For GSM, choose the frequency band (according to country).
- Dial the phone number of the base.

If set accordingly, the following parameters will facilitate the activation and deactivation of the data link:

- Auto-dial: The phone number will automatically be dialed right after the rover modem has been initialized.
- Number of re-dials: In case of unsuccessful connection, the rover will automatically re-dial the base phone number until the data link is established. After “x” unsuccessful re-dials, the modem will automatically switch to the idle state.
- Time out: The rover modem will automatically hang up if no data is received via the data link for the specified time. (This parameter can also be set on the base to deactivate its modem if no data is transmitted for the specified time.)

An alarm will go off in the following cases:

- No phone number dialed
- Invalid phone number
- Line engaged
- All re-dials failed.

Activating a Data Link in NTRIP Mode

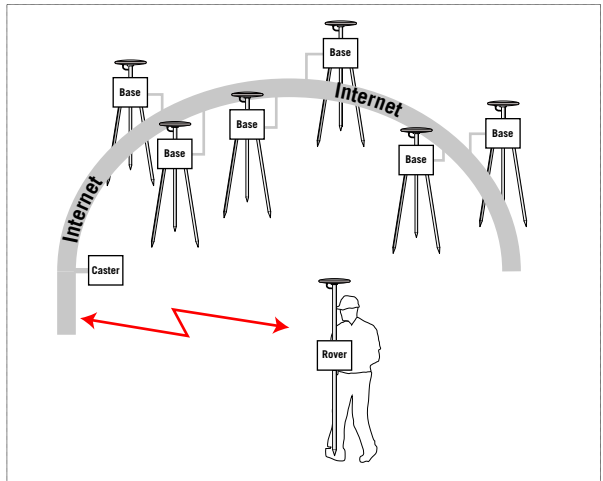

In this mode, you will have to:

- Enter the five identification parameters of the caster, i.e.:
 1. IP address
 2. Mount point
 3. Port number
 4. Login
 5. Password
- The caster will return the source table from which you will be able to select the base from the caster with which you would like the rover to work. The nearest base will be prompted as the default setting.

At this stage, and only if this choice is available from the selected base, you can specify whether you wish the base to send its own RTK correction data or instead, RTK correction data computed from the base network (VRS, MAC or FKP).

Activating a Data Link in Direct IP Mode

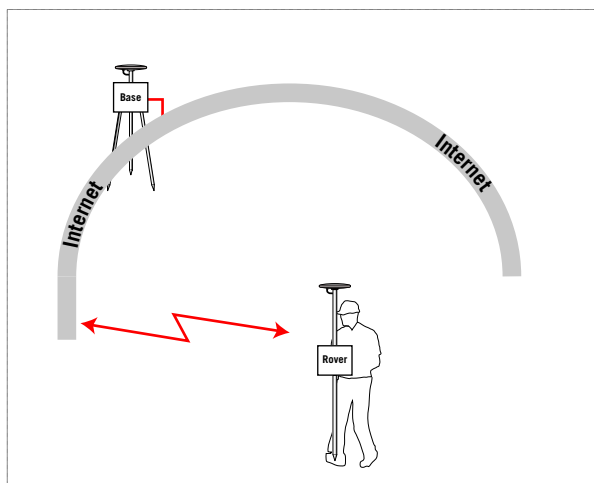

In this mode, you will have to:

- Enter the two identification parameters of the RTK correction data provider, i.e. IP address (xxx.xxx.xxx.xxx) or host name (a URL name), and port number.
- Wait until the data link is active and RTK correction data is received.

NOTE: Introduced late 2008, the Ashtech RTDS PC software allows rovers to communicate with a user-owned base, also through the Direct IP mode. The software serves as a relaying device between the base and the different rovers used in the field. This is an attractive solution for users who want to work in standalone mode. In this respect, this solution resembles that of the radio link, but without its radio coverage limitation as long as there is a cellular coverage in the working area.

Monitoring the Data Link

Making sure the data link is operational at all times is essential to successful field operations. A good indicator to monitor the data link is the *age of corrections*. This parameter is clearly highlighted on the display screens of all Ashtech receivers or field terminals.

When the data link operates normally, the age of corrections is continuously equal to the transfer rate set at the base for transmitting RTK correction data. If for any reason, a correction data set is not received or the rover fails to decode and use it, then the age of corrections will start increasing.

If the increase is only temporary, then you should not care too much about the data link as long as the rover continues to provide “fixed” positions.

But if the age of corrections keeps on increasing, then the problem is more serious as it can only result in a rover losing the “fixed” status for all the positions it delivers. In this case, you should figure out why the data link fails and take the necessary steps to bring it back to work.

So the recommendation is to constantly keep an eye on the age of corrections as you progress in your field operations.

In some of the available Ashtech receivers, you can set a parameter, called “maximum age of corrections” defining an upper limit for the age of corrections. If for any reason the age of corrections reaches this limit, a warning message will alert you.

RTK Correction Data Formats

This section describes the different data formats that can be used by Ashtech receivers to transport RTK correction data from a base to a rover.

One of the preliminary settings you will have to do before using your equipment is to choose one these data formats and set the output rate. This choice should be done in conjunction with that of the data link (see the *"Data Link" section*).

Key Terms and Expressions

Observable: Is another name for the data being collected (observed) by a receiver.

Proprietary Formats

ATOM

ATOM is an Ashtech proprietary format. Being more compact than DBEN, it is replacing it gradually in all the latest Ashtech products.

The table below lists the most commonly used ATOM scenarios to generate RTK corrections (not an exhaustive list; For more details, see *ATOM Reference Manual* or *RNX, TYP: ATOM RNX Differential Message on page 242*):

Message Type	Transfer Rate (default)	Range
Standard observations	1 second	0.05 to 1800 seconds
Compact observations	0	0.05 to 1800 seconds
Super-compact observations	0	0.05 to 1800 seconds
Reference position and antenna height	-	Non user-settable, depends on scenario chosen.
Receiver and antenna attributes	31 seconds	0.05 to 1800 seconds

DBEN

DBEN is an older Ashtech proprietary format. It is a compressed format that includes pseudo-range and carrier phase measurements. The DBEN format consists of two different messages as described in the table below.

Message Type	Transfer Rate (default)	Range
Code and phase measurements	1 second	Less than 1 second up to 300 seconds
Base position	30 seconds	1 to 300 seconds

Standard Formats **CMR, CMR+**

CMR (for *Compact Measurement Record*) is a non-proprietary RTK format that uses data compression techniques to reduce the bandwidth required to transmit the RTK data. In other words, the amount of data to be transmitted on the data link is less with CMR than with many other formats.

There is also an enhanced version of this format called CMR+.

Message Type	Transfer Rate (default)	Range
Observables	1 second	Less than 1 second up to 300 seconds
Coordinates of base position	30 seconds	1 to 300 seconds
Base description	30 seconds	1 to 300 seconds

RTCM

RTCM (for *Radio Technical Commission for Maritime Services*) is the most widespread standard format for transporting RTK correction data. As listed below, there are several versions of the RTCM format available in Ashtech receivers:

RTCM2.3. The message types that exist in this version are numbered from 1 to 34. The most important ones are listed below:

Message Type	Description	Default Transfer Rate
1, 9	Differential GPS Corrections	
3	ECEF XYZ base coordinates	
16, 36	GPS special message	
18	Uncorrected carrier phase	1 second
19	Uncorrected pseudo-ranges	1 second
20	RTK carrier phase corrections	
21	RTK high-accuracy, pseudo-range corrections	
22	Extended base parameter	
23	Antenna type definition	31 seconds
24	Antenna reference point	13 seconds
31, 34	Differential GLONASS corrections	
32	GLONASS Reference Stations Parameters	

RTCM3.0 and 3.1. The message types that exist in these versions are numbered from 1001 to 1029. The most important ones are listed below.

Message Type	Description	Default Transfer Rate
1001	L1-only GPS RTK observables	
1002	Extended L1 only GPS RTK observables	
1003	L1 & L2 GPS RTK observables	
1004	Extended L1&L2 GPS observables	1 second
1005	Stationary RTK reference station ARP	
1006	Base ARP with antenna height	13 seconds
1007	Antenna descriptor	
1008	Antenna descriptor and serial number	
1009	L1-only GLONASS RTK observables	
1010	Extended L1-only GLONASS RTK observables	
1011	L1&L2 GLONASS observables	
1012	Extended L1&L2 GLONASS observables	1 second
1013	System parameter	
1019	GPS ephemeris data	
1020	GLONASS ephemeris data	
1021	Helmert / Abridged Molodenski Transformation Parameters	
1022	Molodenski-Badekas Transformation Parameters	
1023	Residuals, Ellipsoidal Grid Representation	
1029	Unicode text string	
1033	Receiver and antenna descriptors	31 seconds

When a rover is given the capability to decode RTCM messages 1021, 1022 and 1023, the position it computes can be directly expressed in the same local coordinate system as the one used by the base station that provides it with RTK corrections.

Through these messages, you can be sure the rover will automatically use the same transformation parameters as the base to deliver local coordinates.

RTK Position Output

RTK Position Output Mode

Definition

Some field applications require the fastest possible position output rate whereas some others can do with a slower output rate provided the position accuracy is maximum.

Setting the RTK position output mode allows you to choose the position output that is right for your application.

Ashtech receivers offer two different RTK position output modes:

- *Time-tagged RTK* mode, also called “Synchronized RTK” mode.
- *Fast RTK* mode.

Key Terms and Expressions

Latency: Delay between the time (t_0) for which an RTK position is requested and the time (t_1) when the rover starts delivering that position. More precisely, t_1 represents the time when the rover outputs the position data's first character. **Caution!** At time t_1 , the rover will start delivering the position it occupied at time t_0 , and not the position it is occupying at time t_1 . This is true for the two output modes presented in this section.

Epoch: Relevant to a particular time at which a full set of RTK correction data is generated by the base. As this time of data availability is cyclical, each occurrence of this particular time is called an epoch.

Extrapolation: A process through which the rover can continue to compute accurate positions by extrapolating the RTK correction data last received from the base. Generally speaking, in an extrapolation process, the rover tries to predict with the best possible accuracy the most likely value of a quantity in a very near future.

Time-Tagged RTK Output Mode

Principle. In Time-tagged RTK, the rover will compute and output a single RTK position for each epoch of RTK correction data it receives.

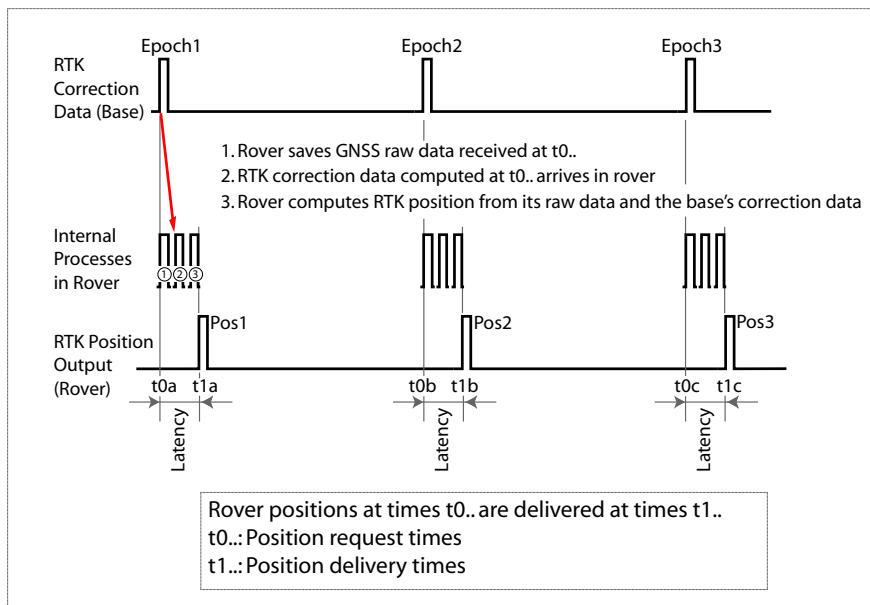

The time when position is requested is t_0 and the time when the rover starts providing the position for time t_0 is t_1 . Times t_0 in the base and the rover are synchronous because they originate from the same clock which is the GPS System time. Here the latency ($t_1 - t_0$) is caused by data processing times in both the base and the rover as well as the base-rover propagation time, the latter being negligible compared to the former. In this configuration, a typical latency time in Ashtech receivers is about 100 ms.

Use Context. Time-tagged RTK should be used when consistent accuracy is more important than the position output rate and when a relatively long latency is acceptable.

Benefit. RTK positions are consistently accurate.

Drawback. Time-tagged RTK can be inconsistent in its output because any interruption in the flow of RTK correction data will cause the rover to cease outputting positions. An interruption could be caused by a problem at the base or

interference in the data link between the base and the rover. Regardless of the cause, the rover will only provide an RTK position when it receives data from the base.

Fast RTK Output Mode

Principle. In Fast RTK, the rover uses the RTK correction data from a single epoch to compute multiple RTK positions. For example, if the base is transmitting RTK correction data every second (1 Hz), the rover can output four RTK positions at intervals of 0.25 second.

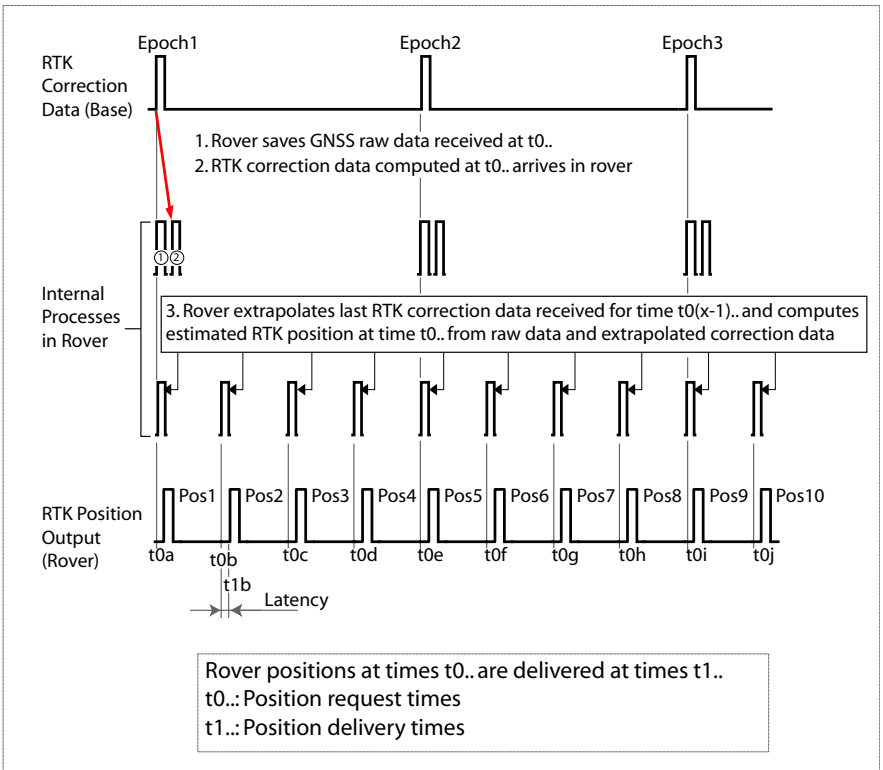

The time when position is requested is t_0 and the time when the rover starts providing the position for time t_0 is t_1 . Times t_{0a} , t_{0e} and t_{0j} in the base and the rover are synchronous because they originate from the same clock which is the GNSS time.

Here the latency ($t_1 - t_0$) is caused by the extrapolation and position processing times in the sole rover. In this

configuration, a typical latency time in Ashtech receivers is 15 ms.

Use Context. Fast RTK should be used when consistent and high-rate position updates are required, such as in machine control or field operator guidance, and when consistent position accuracy is not the highest priority.

Benefits. The position output rate is less sensitive to the rate at which the rover receives RTK correction data.

The latency is shorter than in time-tagged mode thanks to the extrapolation process.

The rover will continue to compute positions even if there is a minor interruption in the RTK correction data. Under good conditions, centimeter-level accuracy can be maintained in the rover even if no RTK correction data is received for several seconds.

Drawback. Accuracy is slightly degraded with extrapolated solutions because the corrections slowly deviate from the true correction.

Insensitivity of the Fast RTK Mode to Missing Base Epochs

The diagram below shows how the two output modes react when an epoch of RTK correction data is missing.

In Time-Tagged RTK

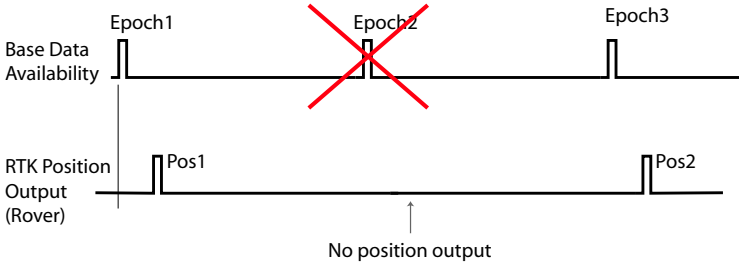

In Fast RTK

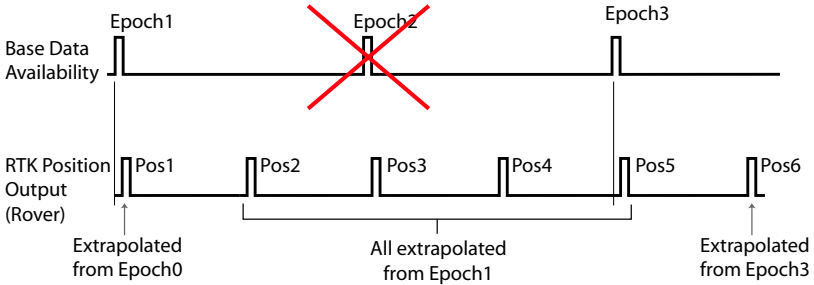

In the above Fast RTK mode example, the output rate has been set to twice the base data output rate.

Whereas the Time-Tagged mode can only stick to the base data output rate, the Fast RTK mode on the other hand can continue to deliver its positions at an unaffected output rate. The only difference, when a base data epoch is missing, is that the last received RTK correction data is extrapolated for a longer time to produce up to four positions (instead of two).

**RTK Position
Output Rate**

In Time-tagged RTK mode, clearly the rover's position output rate is equal to the RTK correction data output rate set at the base. It will also depend on the installed firmware options, if applicable to the Ashtech equipment used.

In Fast RTK mode, the rover's position output rate can be a multiple of the RTK correction data output rate. It is controlled by a specific user-settable parameter and will also depend on the installed firmware options, if applicable to the Ashtech equipment used.



Chapter 6. Troubleshooting



List of Alarms

Alarms are reported on the receiver display screen. A blinking warning sign appears on the status screen prompting you to press the Scroll button so you can read the alarm label.

To acknowledge an alarm message once the alarm label is displayed on the screen, press the Scroll button again. If several alarm messages are reported, press the Scroll button as many times. This will acknowledge each message, one after the other.

If the reason for raising an alarm persists, you won't be able to acknowledge the alarm until you correct the problem.

Some of the alarms listed below can only be the result of a bad serial command submitted to the receiver (in command mode). Serial commands can be applied to the receiver in different ways, from the field terminal running your field software, or from a PC's terminal window (through a serial connection).

#	Rank	Alarm Label	Symptoms & Remedies
0	Medium	Software error	Receiver detected an internal error due to software. If persisting, 2nd-level maintenance is required for the receiver.
1	Medium	Unknown command	Unknown serial command received. Correct syntax and re-send command.
2	Medium	Bad parameter	Not well-formatted parameter in the command sent. Correct syntax and re-send command.
3	Medium	Bad command checksum	Serial command received with bad checksum. Correct checksum and re-send command.
4	Medium	File open error	Receiver failed to open the raw data file. Restart the receiver an try again. If error persists and selected storage medium is USB, change USB key and try again. If error persists and selected storage medium is internal memory, re-format internal memory using command \$PASHS,INI,2 (configuration will be lost).

#	Rank	Alarm Label	Symptoms & Remedies
5	Medium	File close error	Receiver failed to close the raw data file. Try again. If still unsuccessful, turn off the receiver and try again.
6	Medium	File write error	Receiver failed to write data into the raw data file. If the alarm persists, close the file and resume data logging. If error persists and selected storage medium is USB, check that it's not in read-only (remove lock). Else, change USB key and try again. If error persists and selected storage medium is internal memory, re-format internal memory using command \$PASHS,INI,2 (configuration will be lost).
7	Medium	File read error	Receiver failed to read the number of files in the selected storage medium. If error still occurs, change the USB key or re-format the internal memory (see Alarm 4).
8	Medium	File system mount error	Receiver failed to detect the USB key. Remove USB key and re-insert it. If still unsuccessful, use a new USB key.
12	Medium	GSM connection failed	GSM connection has been lost. Try again. Most of the time, the server ends the connection for one of the following reasons: - User name and/or password is incorrect (contact your provider) - Server is faulty (contact provider) - You are outside the area covered by the NTRIP or Direct IP server.
14	Medium	GSM initialization failed	Receiver failed to initialize GSM modem. Check the GSM status icon on the display screen (should indicate Modem is powered on). If error persists, contact your GPRS provider for assistance.
16	Medium	GSM data write error	Receiver failed to write data on the GSM port. Try again. If error persists, restart the receiver. If error persists, call your local dealer or email Ashtech technical support for assistance.
19	Medium	GSM power error	Receiver failed to power on the modem or action required from modem while it is off. If error persists, call your local dealer or email Ashtech technical support for assistance.
21	High	USB removed while file opened	User error. USB key should not be removed while data is being logged to this key. Data file in progress will be entirely lost.
22	High	File transfer Error	Receiver failed to transfer data from the internal memory to the USB key. Change the USB key and try again. If error persists, restart receiver. If error still persists, call your local dealer or email Ashtech technical support for assistance.
23	High	Transfer to USB failed	Receiver failed to transfer data from the internal memory to the USB key because the key is full. Empty the key or insert a new one and then try again.
24	Low	RTC send error	Receiver has detected a task not running properly. Restart receiver. If error still persists, call your local dealer or email Ashtech technical support for assistance
25	Medium	Bad radio settings	Bad \$PASHS,RDP,PAR command received. Consider the following: -Settings may be incompatible with the type of radio used -Settings may have been rejected by the radio Correct command syntax and/or parameters and re-send command.

#	Rank	Alarm Label	Symptoms & Remedies
26	Medium	No radio detected	Receiver fails to communicate with the external or internal radio device, or radio does not respond to your command. Check to see if radio is present (internal radio) or connected and powered on (external radio). Then send your command again.
27	Medium	Radio settings corrupted	Receiver failed to interpret data received from Pacific Crest receiver or transmitter. Check baud rate and retry.
28	Medium	Bad radio response	Receiver failed to interpret data received from transmitter. Check baud rate and retry.
29	Medium	Bad radio channel	Bad \$PASHS,RDP,PAR command received (contains invalid channel number). Consider the following: -Submitted channel number may be absent from channel table -Submitted channel number rejected by radio. Check channel table and send the command again.
30	Medium	No GNSS detected	GNSS board found missing. Restart receiver. If error persists, call your local dealer or email Ashtech technical support for assistance.
31	Low	Bad PVT received	Bad position data delivered by GNSS board. If error persists, call your local dealer or email Ashtech technical support for assistance.
32	Low	Bad PVT decoded	Bad position data delivered by GNSS board. If error persists, call your local dealer or email Ashtech technical support for assistance.
33	Low	PVT multiflag	If error persists, call your local dealer or email Ashtech technical support for assistance.
34	Medium	Unknown option code	OPTION command received includes invalid option code. Check command syntax/parameters and send the command again.
35	Medium	C3 code checksum is bad	Option codes are corrupted at power-on. Re-install receiver options.
36	High	Option has expired	At receiver power-on, all installed firmware options are tested for validity. This alarm is activated if at least one option has expired. Need to purchase option if no longer available.
37	High	All attempts failed	Number of tries exceeded. Check phone number. Resume the connection procedure from the beginning. If error persists, call your local dealer or email Ashtech technical support for assistance
38	High	Memory full	Data memory full. Data logging stopped or impossible. You need to empty memory partially or entirely before data logging can be resumed.
39	Low	Spy too long	A Debug command. Apart from acknowledging the alarm, no particular action required.
40	Medium	GSM already in DIP Mode	Source table requested whereas GSM already used in DIP mode. End DIP connection before requesting the source table.
41	Medium	GSM currently in NTRIP Mode	Source table requested whereas GSM already used in NTRIP mode. End NTRIP connection before requesting the source table.
43	Medium	Invalid mount point	You are trying to connect the receiver to an invalid mount point. Correct mount point parameters and try again.
44	Low	Input buffer full	If error persists, call your local dealer or email Ashtech technical support for assistance.
45	Medium	GSM Pin code invalid	Correct pin code and try again. If error persists, contact GPRS provider to fix the problem.
46	Medium	GSM band error	Correct GSM band and try again. If error persists, call your local dealer or email Ashtech technical support for assistance.

#	Rank	Alarm Label	Symptoms & Remedies
47	Medium	GSM protocol error	Correct protocol used and try again. If error persists, call your local dealer or email Ashtech technical support for assistance.
48	Medium	GSM CSD mode error	Problem configuring the modem in CSD mode. Try again. If error persists, call your local dealer or email Ashtech technical support for assistance.
49	Medium	APN error	Problem configuring the APN. If error persists, contact GPRS provider to fix the problem.
51	Medium	GPRS login error	Check GPRS login. If error persists, contact GPRS provider to fix the problem.
53	Medium	GPRS password error	Check GPRS password. If error persists, contact GPRS provider to fix the problem.
54	Medium	GPRS connection failed	Receiver failed to connect to GPRS. Check GSM antenna. Check GPRS parameters and reception level and try again.
56	Medium	Invalid caster hostname	Correct caster hostname and try again.
57	Medium	Invalid caster port	Receiver failed to access the caster through the port mentioned. Check caster port number.
60	Medium	Disconnect. from GPRS failed	Receiver failed to disconnect from GPRS. Try again. If still unsuccessful, shut down the receiver.
61	Medium	Connect. to DIP failed	Receiver failed to connect to the specified DIP address. Check DIP parameters and access rights and try again.
62	Medium	CSD dial error	Receiver failed to dial the specified phone number.
63	Medium	CSD hangup error	Receiver failed to hang up. Shut down the receiver.
66	Medium	Auto pickup error	Receiver failed to set "auto pickup" in GSM modem
67	Medium	No SIM card detected	Receiver needs SIM card to operate in requested mode. Install SIM card or check that the installed SIM card has been inserted correctly. If still unsuccessful, call your GPRS provider to make sure the SIM card holds the information to make it usable.
69	High	Too many files	Up to 96 files (index A to Z) can be logged per day, based on the same site name. To log more files on the same day, change the site name.
70	High	Low battery	Battery output voltage below lower limit defined by \$PASHS,PWR,PAR.
71	High	Low voltage	External DC source voltage below lower limit defined by \$PASHS,PWR,PAR.
72	Medium	Storage overflow	Storage overflow. This can be solved by reducing the data recording rate.
90	Medium	BTH Name Rejected	Bluetooth name rejected. Try another one.
91	Medium	BTH PIN Rejected	Bluetooth pin rejected. Try another one.
108	High	Option K has expired	The use of the [K] firmware option was granted to you for a limited period of time, which has now expired. Please contact Ashtech to renew the use of this option.
109	High	Option F has expired	The use of the [F] firmware option was granted to you for a limited period of time, which has now expired. Please contact Ashtech to renew the use of this option.
110	High	Option Z has expired	The use of the [Z] firmware option was granted to you for a limited period of time, which has now expired. Please contact Ashtech to renew the use of this option.

#	Rank	Alarm Label	Symptoms & Remedies
111	High	Option S has expired	The use of the [S] firmware option was granted to you for a limited period of time, which has now expired. Please contact Ashtech to renew the use of this option.
112	High	Option P has expired	The use of the [P] firmware option was granted to you for a limited period of time, which has now expired. Please contact Ashtech to renew the use of this option.
113	High	Option G has expired	The use of the [G] firmware option was granted to you for a limited period of time, which has now expired. Please contact Ashtech to renew the use of this option.
114	High	Option M has expired	The use of the [M] firmware option was granted to you for a limited period of time, which has now expired. Please contact Ashtech to renew the use of this option.
115	High	Option L has expired	The use of the [L] firmware option was granted to you for a limited period of time, which has now expired. Please contact Ashtech to renew the use of this option.
116	High	Option N has expired	The use of the [N] firmware option was granted to you for a limited period of time, which has now expired. Please contact Ashtech to renew the use of this option.
117	High	Option C has expired	The use of the [C] firmware option was granted to you for a limited period of time, which has now expired. Please contact Ashtech to renew the use of this option.
118	High	Option R has expired	The use of the [R] firmware option was granted to you for a limited period of time, which has now expired. Please contact Ashtech to renew the use of this option.
192	Medium	Baseline Out of Range	The receiver won't use the received corrections data because the distance to the base station is greater than 3 kilometers. Work with a closer station or buy the [K] firmware option (full RTK).

Receiver is Not Tracking Satellites

	RTK Base	RTK Rover	PP Base	PP Rover
Relevant to	•	•	•	•

Step 1. Has the Receiver Been Powered Up?

To determine if the receiver is powered up, examine the power LED on the front panel of the receiver. If the LED is on, the receiver is on.

1. **If the receiver is not powered up**, turn on the receiver by pressing and holding the power key on the front panel. The button must be held for a few seconds since there is a delay in power on. You will see the power LED turn on and the display will show the logo followed by the message "Starting...".

2. **If the receiver does not power up**, check the power source. The receiver supports both internal (battery) and external power sources.
If using the internal power source, make sure the internal battery has been fully charged before it was inserted in the receiver. A too low battery will prevent the receiver from powering up.
If using external power, check to ensure the power cable is properly connected to both the external battery and the receiver.
 - If the cable is properly connected, check the power level of the external power source. If low, replace the battery with a charged battery and turn on the receiver.
 - If the external power source is good and the cable is connected to both the receiver and the power source, there may be a problem with the cable. If available, try a different power cable. If the new cable works, the old cable is malfunctioning. Call your local dealer or email Ashtech technical support to have the cable repaired.
3. **If the receiver is now powered up**, go to step 2.

Step 2. Does the Number of Tracked Satellites Stay Abnormally Low?

1. **Check the information displayed on the receiver front panel.** In the upper line, starting from the left, the first number displayed should gradually rise from 0 to 8 or more. This information represents the number of tracked satellites. In the same time, the last number in the same line should increase as well, in the same proportion. This information represents the number of satellites actually used by the receiver, and should be equal to, or slightly less than, the first number in the line.
2. **If the receiver fails to track any satellites** after a few minutes of operation, see if you can improve this by moving the receiver to a better place (a more open-sky area) where there can't be any doubt on the possibility for a receiver to track satellites.
3. **If the receiver still fails to track any satellites**, a component may be malfunctioning. Call your local dealer or email Ashtech technical support for assistance.

Receiver is Not Logging Data

	RTK Base	RTK Rover	PP Base	PP Rover
Relevant to	•	•	•	•

Raw Data Logging Icon:



The Raw Data Logging icon on the front panel of the receiver will be animated when data logging is in progress.

Examining the General Status screen, you determine that the receiver is not logging data to memory. Follow the procedures below to determine the cause of this problem.

Step 1. Has Data Logging Been Started?

At receiver power up, data logging is disabled in the receiver (default setting). To start data logging, press the Log button on the front panel. By default, raw data is written to the receiver's internal memory.

1. **If the Raw Data Logging icon starts blinking** (animated icon), then the problem is solved. **Warning!** The Raw Data Logging icon may blink throughout a logging session, but if not a single satellite is received during this time, then your raw data file will be empty.
2. **If the problem is not yet resolved**, go to step 2.

Step 2. Is the Currently Selected Memory Usable?

The receiver logs raw data to the internal memory (recommended) or to a USB stick. With the default settings, the selected memory is the internal memory. Changing the storage medium can only be made using the field software running your field terminal. You can determine which memory is currently selected by reading the memory screens. The “*” symbol indicates the currently selected storage medium.

If the USB stick is the currently selected memory, there is no USB stick connected and you are using the receiver in standalone mode (no field terminal used), then the receiver won't start data logging when you press the Log button.

1. **If you are using the receiver alone** and the currently selected memory is the USB stick, do one of the following:
 - Connect a USB stick to the receiver through the USB device cable provided and press the Log button again.
 - Restore the default settings (by pressing the Log+Scroll+Power buttons simultaneously) in order to make the internal memory the active memory. Press the Log button again.

If neither of these two actions resolves your problem, go to step 3.

Step 3. Is the Currently Used Memory Full?

Data logging will stop automatically or won't start if the storage medium used (internal memory or USB stick) is full. On the General Status screen, read the remaining percentage of free memory (second line, last number in the line).

1. **If "0%" is displayed**, then the memory used is full. Do one of the following:
 - Change the storage medium
 - Using your field terminal, empty the memory or delete the files you don't need anymore.

If neither of these two actions resolves your problem, you may have a malfunctioning receiver. Contact your local dealer or email Ashtech Technical Support for assistance.

2. **If the memory is not full (>0%)**, you may have a malfunctioning receiver. Contact your local dealer or email Ashtech Technical Support for assistance.

Radio Data Link Fails to Provide Base Corrections to Rover

	RTK Base	RTK Rover	PP Base	PP Rover
Relevant to		•		

The Data Link icon is displayed on the rover's General Status screen when base corrections are received and a float or fixed solution is available. Next to it is the age of corrections, a value which should not normally exceed a few seconds when the data link operates smoothly.

After examining the General Status screen, you determine that the rover is not receiving data. Follow the outline below to troubleshoot this problem.

Step 1. Is the Receiver Fitted with the Appropriate Radio Module?

The radio module used should be compatible with the radio transmitter used at the base. Several sub-bands and channel bandwidths are available for the radio (see *Communication Modules and Associated Antennas on page 3*).

1. **If you are using the right module**, go to step 2.
2. **If you are not using the right module**, turn off the receiver and replace the module with the right one. You then need

to restore the default settings in the receiver (by pressing the Log+ Scroll+ Power buttons simultaneously on the front panel) so the receiver can recognize and use the new module. If using the right module does resolve the problem, go to step 2.

NOTE: There is no particular action required to power up the radio module other than to power up the receiver. This automatically applies power to the radio module.

Step 2. Is the Radio Antenna Connected to the Radio Module?

The radio module cannot operate properly without an antenna. Make sure the antenna is connected to the radio module.

1. **If the antenna is not connected**, connect the radio antenna (provided in the radio receiver kit) to the radio module. Ensure that the connection is secure. If the problem is not yet resolved, go to step 3
2. **If the antenna is connected**, ensure the connection to the radio module is secure. If the problem is not yet resolved, go to step 3.

Step 3. Are the Rover Radio Settings Compatible with those of the Base Radio?

The rover radio must use settings that are compatible with those of the base radio, in order for the rover to receive corrections from the base. (This means you are supposed to know the currently used base radio settings.)

1. **Check the radio settings in the rover:**
Use the field software running your field terminal to check the frequency, protocol and “Over the Air” baud rate used.
2. **If the rover radio is set properly**, go to step 4.

Step 4. Is the Line of Sight Between the Base and the Rover Antennas Obstructed?

Although radios are fairly robust, an excessive amount of obstructions can block out the signal.

1. **If the line of sight is not obstructed**, go to step 5 below.
2. **If the line of sight is obstructed:**
 - Move to a less obstructed location. In order to test if the system is functioning properly, move to a location that does not have an obstructed view between the base and rover radio antennas.
 - If this is not possible, move to higher ground or a location where there is less obstruction.
 - If, after moving, the rover radio begins to receive data from the base, then the previous location is too obstructed from the base. You will need to either raise the base radio antenna higher, or move the base to a

location with less obstruction between the base and rover radio antennas.

3. If the problem is not yet resolved, go to step 5.

Step 5. Are you Within Range Specifications of Your Radio System?

The range within which your radio system will function varies greatly with the conditions under which the system is being used. With clear line of sight between the base and rover radio antennas, and no interference on the frequencies you are working on, a UHF system can function with tens of miles of separation. Unfortunately, these are ideal situations seldom found. In most situations, the range of UHF radio will be between 5 and 10 miles.

1. **If you are not within range specifications**, move within range. Either move closer to the base, or move the base closer to you. If the problem is not yet resolved, go to step 6.
2. **If you are within range specifications**, move closer to the base to test the system. Since radio range is difficult to predict due the varying effects of local conditions, try moving closer to the base in an attempt to resolve the problem.

If by moving closer you find that the rover radio begins to receive data, the previous location is out-of-range of the radio system. You will need to elevate the base radio antenna or move the base to a location closer to you to solve the problem. If the problem is not yet resolved, go to step 6.

Step 6. Is the Radio Being Jammed?

When working with UHF radios, it is possible that the frequency you are using is being shared with other people in your vicinity. Traffic on this frequency can interfere with the rover's ability to receive data from the base. The effect may be no reception of base data or intermittent reception of data. Both are detrimental to proper operation of the RTK system. Interference can be a problem with UHF radios.

There are two methods to determine if there is traffic on the frequencies you wish to use. The best method is to acquire a handheld scanner and to listen for traffic on the frequency you plan to use. The second method is to observe the Data Link icon on the rover's General Status screen. The base and rover radio will receive any traffic on the frequency they are set to causing this icon to appear. This is best done before setting up the base to transmit data. Any appearance of the Data Link icon indicates some traffic on your frequency.

1. **If there is no jamming**, your radio module or radio antenna may be malfunctioning. There is no way to further isolate this problem unless you have spares for these components. Call your local dealer or email Ashtech technical support for assistance.

2. **If there is jamming:**

- Lower the sensitivity of the rover radio using the field software running your field terminal. The software lets you change the sensitivity of the rover radio, and you can also lower the sensitivity of the PDL radio via the front panel display.

Lower the sensitivity of the rover to medium or low. If the traffic on your frequency is not strong in power, lowering the sensitivity of the rover radio may cause the radio to ignore the traffic. This will not help if the traffic is caused by a nearby or very high powered radio.

The disadvantage of lowering the sensitivity is a reduction in the range of your radio system. A lower sensitivity at the rover may cause the rover to not hear the base transmissions as the rover moves farther away from the base.

- Try another frequency. If you are licensed to operate on more than one frequency, move to a different frequency in hopes that the new frequency has less traffic.

If you have a license for only one frequency, you may need to find another frequency in your area that is clear of traffic in order for the system to function reliably and acquire a license for this frequency if possible.

Data Link Okay but No Fixed Position Computed

	RTK Base	RTK Rover	PP Base	PP Rover
Relevant to		•		

Once the receiver is set to function in RTK (i.e. RTK firmware option has been enabled), it will compute RTK quality positions. In order to accomplish this, the rover must collect raw satellite data at its position and also receive RTK

correction data transmitted by the base. Without these two components, the rover will not be able to fix RTK position solutions.

To determine if the rover is computing a fixed position, you can read the General Status screen (2nd parameter in upper line).

Using either the display screen or your field terminal, you have determined that the rover system is not computing a “Fixed” position. Follow the steps outlined below to troubleshoot this problem.

Step 1. Is the Radio Receiving Base Data?

To determine if the rover is receiving base data, examine the 2nd line on the General Status screen. The Data Link icon should be visible. Refer to *Radio Data Link Fails to Provide Base Corrections to Rover on page 106* if you need to fix this problem, and then come back to this procedure.

Step 2. Is the Receiver Tracking satellites?

Use either the front panel of the receiver or the field software running on your field terminal to determine if the rover is tracking satellites.

- **If the receiver is not tracking satellites**, refer to *Receiver is Not Tracking Satellites on page 103* and then come back to this procedure.
- **If the receiver is tracking satellites**, go to step 3 below.

Step 3. Are The Base and Rover Tracking at least 5 Common Satellites?

In order for the rover to compute an RTK position, the base and rover must observe data from at least 5 common healthy satellites simultaneously. Without this common data, the rover cannot compute an RTK position.

Use the receiver front panel or the field terminal to determine if the base and rover are indeed tracking at least 5 common healthy satellites.

1. **If the base and rover are not tracking at least 5 common satellites:**
 - Check satellite availability. Use Web Mission Planning (<http://asp.ashtech.com/wmp/>) to check satellite availability for your current location and time. Look for the number of satellites available higher than 5° above the horizon. Ensure at least 5 healthy satellites are available. If not, you will need to perform your survey at another time.

If the problem is not yet resolved and at least 5 satellites are now tracked and used, your rover may be

malfunctioning. Contact your local dealer or email Ashtech technical support for assistance.

- Move the base or rover if sites have satellite obstructions. If your base or rover site has any obstructions 5° above the horizon, the obstructions may be blocking essential satellites. If obstructions exist at the base or the rover, move the system to an open area.

If the problem is not yet resolved and at least 5 satellites are now tracked and used, your rover may be malfunctioning. Contact your local dealer or email Ashtech technical support for assistance.

2. **If the base and rover are tracking at least 5 common satellites**, your rover may be malfunctioning. Contact your local dealer or email Ashtech technical support for assistance.

Rover is Computing Positions with High Uncertainties

	RTK Base	RTK Rover	PP Base	PP Rover
Relevant to		*		

You find that the rover is computing a position but the uncertainties (HRMS, VRMS) assigned to the position are unacceptably high. Follow the steps outlined below to troubleshoot this problem.

Step 1. Is the Receiver Set to Function as an RTK Rover?

The rover must be set to function in RTK rover mode in order for it to compute accurate RTK positions. If the rover is not set in RTK rover mode, the receiver will compute autonomous positions which could contain about 10 meters or more of error. This is probably the problem if HRMS and VRMS values are in the 10s of meters. Check that the system is configured as an RTK rover (see General status screen).

- **If the receiver is not set to function as an RTK rover**, use the field software running your field terminal to set the different parameters making the receiver an operational rover.
- **If the receiver is set to function as an RTK rover**, go to step 2.

Step 2. Are the Base and Rover Tracking at least 5 common Satellites?

Although the rover is capable of computing a position with only 4 common healthy satellites with the base, the rover will not attempt to fix ambiguities unless 5 common healthy satellites are observed. Fixing ambiguities is a required process for the rover to compute highly precise RTK positions. The receiver will inform you if you currently have a fixed ambiguity solution or a float ambiguity solution. Your field application software will also inform you which satellites are being tracked by the base and which are being tracked by the rover and whether or not these satellites are healthy. If you find that your solution will not fix, look to determine if the base and rover are indeed tracking at least 5 common healthy satellites.

1. If the base and rover are not tracking at least 5 satellites:

- Check satellite availability. Use Web Mission Planning (<http://asp.ashtech.com/wmp/>) to check satellite availability for your current location and time. Look for the number of satellites higher than 5° above the horizon. Ensure at least 5 healthy satellites are available. If not, you will need to perform your survey at another time.

Go to step 3 below if the problem is not yet resolved.

- Move the base or rover if sites have satellite obstruction. If your base or rover site has any obstructions higher than 5° above the horizon, the obstructions may be blocking essential satellites. If obstructions exist at the base or rover, move the system to an open area.

Go to step 3 below if the problem is not yet resolved.

2. If the base and rover are tracking at least 5 satellites, go to step 3 below.

Step 3. Are HDOP & VDOP Values Too High for Precision Requirements?

Dilution of Precision (DOP) values give a quality indication of the satellite geometry at any given time. Satellite geometry is important to the precision of an RTK solution.

In fact, the DOP value is used as a multiplier in the computation of position precision. For example, in the computation of horizontal RMS (HRMS), an estimated precision value is multiplied by the HDOP at that given time to produce HRMS. The larger the HDOP value, the larger the HRMS value. The same relationship holds for VDOP and VRMS.

Therefore, poor satellite geometry will result in poor solution precision. The smaller the DOP value, the better the geometry and solution precision.

Your field software allows you to view different DOP values. If your precision estimates (HRMS, VRMS) do not meet expected values, use this feature to examine the current DOP values.

1. **If DOP values are too high**, look for a satellite window with more suitable DOP values to perform the survey:

Use Web Mission Planning (<http://asp.ashtech.com/wmp>) to examine expected DOP values for periods during which you would like to perform your survey. Avoid surveying during periods where DOP values are above 4. For the highest level of accuracy, limit surveying to periods where DOP values are between 1 and 2.

Remember that obstructions to line of sight between the GPS antenna and the satellites will block out satellite signals. Every time a satellite is lost due to obstructions, DOP values will be adversely affected. An obstructed area may not be suitable to meet your precision needs due to the adverse effect on satellite geometry.

2. **If DOP values are not too high**, go to step 4 below.

Step 4. Are Precision Requirements Too Stringent for RTK?

If the RTK system is not delivering the precision requirements you need for your specific task, it is possible that your precision requirements are too stringent for the RTK system. Review your system documentation to determine the precision specifications for the RTK system.

- If the precision is not beyond capability, then the rover may be malfunctioning. Contact your local dealer or email Ashtech technical support for assistance.
- If the precision is beyond capability, your precision requirements are not attainable through RTK surveying. You will need to find some other measurement system to perform your survey.

This concludes the troubleshooting section. If the tips given here did not help you to resolve your problem with your system, please call your local dealer or email Ashtech Technical Support for assistance.

Logging Data for RTK Troubleshooting Purposes - Reporting a Problem to Ashtech Tech Support

Logging the data received, processed and output by the receiver may help Ashtech isolate RTK malfunction when none of the available troubleshooting procedures has allowed you to solve the problem.

This procedure is based on the capability of the receiver to execute serial commands from a text file stored on a USB key. You can create by yourself the text file required to launch this process. Create the text file with the following content, making sure the four commands are typed in that order:

```
$PASHS,MEM,2  
$PASHS,ATL,ON
```

(Press the ENTER key after typing the last command. This is mandatory.)

Save the file as “autoconfig.cmd” and copy it to the USB key. By naming the file that way, the receiver will automatically prompt you to run the script when you connect the USB key to the receiver.

Then follow the instructions below:

- Check that the receiver is not currently logging data. If it is logging data, press the Log button to stop data logging.
- Connect the USB key to the receiver. Wait until the USB logo appears on the receiver screen and a message is prompted (**Upload Script?**).
- Accept the request by pressing the Log button. The receiver will then run the script from the text file, and then will start logging the data, as indicated by the blinking diskette icon on the receiver screen.
- After enough data has been recorded, firmly press the Log button once, then wait until the diskette icon on the screen stops blinking. When this happens, this means data recording has been stopped.
- Turn off the receiver.
- Remove the USB key and read the content of the USB key on your computer.
- Send the collected data file (ATL_yymmdd_hhmmss.log) to Ashtech for further diagnosis.

When reporting a problem to Ashtech Technical Support, please attach to your email the response of your receiver to the following commands:

```
$PASHQ,RID
```

\$PASHQ,VERSION
\$PASHQ,OPTION
\$PASHQ,PAR

Log these responses in Terminal mode (with Hyperterminal for example) at a speed of 19600 Bd in a text file (*.txt).



Chapter 7. Miscellaneous



ATOM File Naming Conventions

Raw data files in ATOM format are named using the following syntax:

G<Site><Index><Year>.<Day>

Where:

Item in Filename	Description
G	Header indicative of a file containing ATOM data.
<Site>	A 4-character string recalling the name of the site where data was collected (a point name in static, a trajectory name in kinematic, or name of last surveyed point in stop & go). The default string is four underscores ("____").
<Index>	Order number of file being recorded (in the form "A" to "Z" for the first 26 files logged in the same day, then "AA" to "ZZ" for the next ones recorded in the same day, starting from the 27th file).
<Year>	Last two figures of current year (e.g. "08" for 2008) for up to 26 files recorded in the same day, then only the last figure of current year for the 27th and next files.
.<Day>	File extension: a three-figure number representing the current day number in year (1.. 365).

Example of first file logged on May 6th 2008 on point 584V:

G584VAA8.127

Reverting to V1 for All ATOM Messages Generated by the Receiver

The current version of ATOM is V2 (October 2011). Your receiver is by default configured to generate ATOM V2 messages.

For some reason, for example you are using your receiver in conjunction with older equipment, you may need to revert to V1. This is possible using the \$PASHS,ATM,VER command (see *ATM,VER: Setting the Version of ATOM Messages on page 167*).

The history of the ATOM format can be summarized as follows:

- 2009: First official release of ATOM (V1 version)
- 2011: Second official release of ATOM (V2 version).
ProMark 800 is the first commercial receiver to benefit from this new format version.

For more information on the ATOM format, please refer to the *ATOM Reference Manual* (P/N 631648).

Time-tagged RTK vs. FAST RTK Position Output

Your receiver can deliver RTK positions either in Time-Tagged or Fast RTK mode. The default mode is Fast RTK.

If you wish your receiver to operate in Time-Tagged mode, use the appropriate serial command to switch into that mode (see *CPD,FST: RTK Output Mode on page 180*).

In its standard version, the receiver features a Fast RTK mode with an output rate of 2 Hz. With the FASTOUTPUT firmware option, the output rate is 20 Hz. After purchasing this option, use the \$PASHS,OPTION command to install it. See *OPTION: Receiver Firmware Options on page 218*.

Special Button Combinations Summary

Button Combination	Receiver State	Function
Power+Log+Scroll	OFF	Restores Factory Settings.
Power+Scroll	OFF	Initiates firmware update from USB key.

Refer to *Special Button Combinations on page 9* for more information.

Reset Procedure

The receiver may be reset to the default settings using the Log+Scroll+Power button combination. Release the three buttons only after the logo is displayed.

The reset procedure is also used to poll the radio module. If a new module is detected, the receiver will update its database so it can successfully communicate with the new module.

The default settings can also be restored using the \$PASHS,INI command. With this command, you can ask more than a simple “restore default settings”. See *INI: Receiver Initialization on page 200*.

Using a USB key to Save/Upload Receiver Configurations or Copy User Data

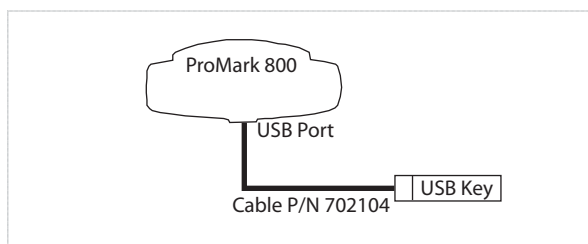

Generally speaking, after connecting a USB key to the receiver, the USB logo will appear on the screen after a while. Then three different screens (or less, depending on the content of the USB key) will be shown in succession, at a rate of 10 seconds, provided no button is pressed in the meantime. These three possible screens are shown below.

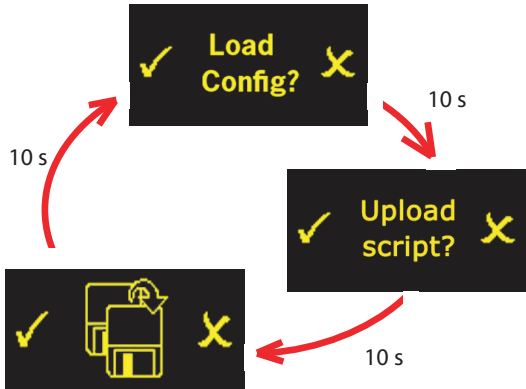

- **Load Config?** will first show up if a PAR file is stored on the USB key.
- **Upload Script?** will show up after 10 seconds of displaying **Load Config?** if the USB key also contains a text file named "autoconfig.cmd" containing a list of \$PASH commands.
- Symbols representing two storage media will show up after 10 seconds of displaying **Upload Script?** inviting you to copy the user data (raw data files, log files) from the internal memory to the USB key.

Note that the first two screens will be skipped if the required files are not found on the USB key.

While either of these three screens is displayed, you can either accept the corresponding request by pressing the Log button (left-hand button), or reject it by pressing the Scroll button (right-hand button).

When you reject the request, the screen immediately switches to the next screen.

The receiver will indefinitely continue to browse through the different possible screens, at the same rate, as long as no action is taken and the USB key remains connected to the receiver.

"Load Config?" Procedure

When the message below appears on the screen, press the Log button to start the upload procedure:

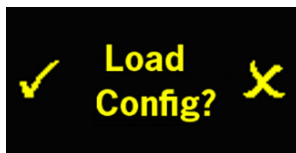

The following messages will appear in succession:

Analyzing File...
Loading PM_<Date>.PAR...

At the end of the upload procedure, the receiver will be re-booted automatically. Disconnect the USB key from the receiver and let the receiver re-boot.

NOTE: There is another way of uploading a configuration to a receiver, which is to use the \$PASHS,PAR,LOD command, whether the configuration file (a PAR file) is present on the connected USB key or in the receiver's internal memory. See *PAR,LOD: Configuring the Receiver From a PAR File on page 219*.

“Upload Script?” Procedure

When the message below appears on the screen, press the Log button to start the upload script procedure:

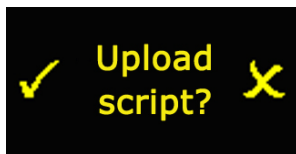

The receiver will start executing the script of commands. For more information on this procedure, see *Running Serial Commands from a USB Key on page 146*.

Copying User Data

When the message below appears on the screen, press the Log button to start copying the files to the USB key:



Note that the procedure will be aborted from the start (not a single file copied) if the free memory space on the USB key is found less than the total size of files to be copied.

Saving a Receiver Configuration

Saving the whole configuration of a receiver may be done using the \$PASHS,PAR,SAV command. The configuration is saved as a PAR file, which is a binary file, and not an ASCII file that would list all the \$PASH commands relevant to the receiver configuration.

The file naming convention used is the following:

PM_<Date>.PAR

Typically, the configuration will be saved on a USB key so that later on you may possibly upload this configuration to another of your receivers.

Connect the USB key as shown at the beginning of this section before running the command from your data collector or command terminal.

The configuration can alternately be saved to the internal memory if necessary. For more information on the save command, please refer to *PAR,SAV: Saving the Receiver Configuration To a PAR File* on page 220.

Asking a Rover to Use the Same Local Coordinate System as the Base

In some applications, you may want your rover to deliver its position in the same local coordinate as the one in which the reference position of the base used is expressed.

This can be done by selecting the same local coordinate system in the job open on rover side, but there is no guarantee that the coordinate system you select in your job uses exactly the same transformation parameters as the one used at the base.

There is another more efficient and automatic process that guarantees that the same coordinate transformation is used on both sides, which is to ask the base to generate RTCM messages 1021, 1022 and 1023 and enable the rover to receive, decode and use them.

Using these messages, you can be certain that the rover will use exactly the same local coordinate system as the base, without any errors or discrepancies.

Implementing this function in the rover is simply made by using the appropriate \$PASHS,LCS command (see *LCS: Enabling/Disabling Use of Local Coordinate System* on page 201).

Once the function is enabled in the rover, and provided the base generates these RTCM messages and the rover actually

receives them, then the rover position will automatically be delivered in the requested local coordinate system.

Firmware Upgrade Procedure

Firmware upgrades can be downloaded from the Ashtech FTP server in the form of one or more compressed “.tar.bz2” files. The file(s) provided, as well as the step-by-step upgrade procedure are given in the relevant *Release Note*.

Completing a firmware upgrade procedure may take up to 30 minutes. For this reason, it must be run with the receiver powered from both a fully charged internal battery and the AC/DC power supply kit. You also need a USB key to make the upgrade files available to the receiver.

Follow the instructions below to complete the upgrade of your receiver:

1. Check that the USB key used for the upgrade is not write-protected and then connect it to your computer.
2. Using Windows Explorer, copy the “.tar.bz2” file(s) to the root directory of the USB key.
3. Check that there is at least 10 Mbytes of free memory left on the USB key. The free memory will be used during the upgrade for decompressing data.
4. Disconnect the USB key from the computer (after taking the usual safety precautions related to the USB standard).
5. Make sure the receiver you want to upgrade is OFF and ready for upgrade (i.e. internal battery present and external AC/DC power supply connected and on).

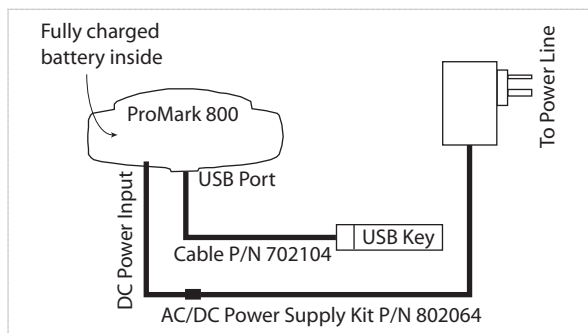

6. Connect the USB key now containing the upgrade files to the receiver's USB connector through cable P/N 702104 (provided).
7. Hold down the Scroll button and then press the Power button for about 10 seconds. After about 30 seconds, the Ashtech logo on the screen is replaced with the "Upgrade in progress" message, meaning that the upgrade procedure has now started.
8. Let the receiver proceed with the upgrade. **Take care not to turn off the receiver while the upgrade is in progress.**

The receiver screen will display successively:

```

Upgrade in progress.
Writing xx%
ramdisk.img.gz
...
uboot
uimage_pm4_rd
Upgrading GNSS
...
Erasing partitions
Creating Backing file
Creating partition
Config
Starting...

```

9. Follow the instructions provided in the *Release Note* to complete the upgrade. The receiver is automatically restarted at the end of the procedure.
10. Disconnect the USB key and its cable from the receiver.
11. Check that the new firmware is installed (read the second line on the Receiver Identification Screen).

Enabling a Firmware Option

- Set up your equipment in such a way that it can successfully receive and process a serial command sent from outside the equipment. See *Applying Commands Through Bluetooth or a Serial Port on page 144* in this manual to know how this can be done.
- Use the \$PASHS,OPTION serial command to enable the firmware option. Refer to *OPTION: Receiver Firmware Options on page 218* in this manual to learn how to use this command.

Through this command, you will enter the code provided by Ashtech after you purchased the option. Entering this code into the receiver will unlock the option.

Configuring Serial Port A

- Set up your equipment in such a way that it can successfully receive and process a serial command sent from outside the equipment. See *Applying Commands Through Bluetooth or a Serial Port on page 144* in this manual to know how this can be done.
- Use the \$PASHS,MDP serial command to configure serial port A as an RS232 or RS422 port. Refer to *MDP: Setting Port A to RS232 or RS422 on page 207* in this manual to learn how to use this command.
- Use the \$PASHS,CTS command to enable/disable hardware handshaking. Refer to *CTS: Handshaking on page 186*.

NOTE: A Bluetooth connection is also possible between a Bluetooth-enabled computer and the receiver.

Installing a SIM Card

- Turn the ProMark 800 upside down.
- Using a flat screwdriver, loosen the two quarter-turn screws of the radio module (or compartment door if your ProMark 800 was purchased without a radio module).
- Pull the radio module or compartment door out of the ProMark 800. This unveils the printed circuit board located at the bottom of the case, on which you can insert your SIM card.
- Insert the SIM card as shown below.

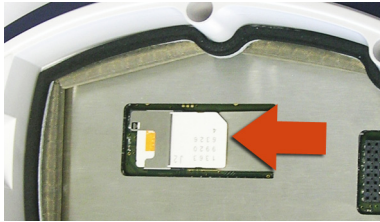

- Put the radio module or compartment door back in place. Tighten the two screws.

Changing the Radio Module or Using One for the First Time

- Turn the ProMark 800 upside down.
- Using a flat screw driver, loosen the two quarter-turn screws of the radio module (or compartment door if your ProMark 800 was purchased without a radio module).
- Gently pull the module (or compartment door) out of the ProMark 800. The picture below shows a ProMark 800 from which a radio module was removed.



- Insert the new radio module. This should be done gently, taking care not to damage the 16-pin male connector, which connects to the bottom of the receiver. When the module is fully inserted, tighten the screws.
- When next turning on the ProMark 800, don't forget to use the Power+Log+Scroll button combination. By restoring

the factory settings, this procedure will allow the receiver to query, and so identify, the new radio module.

Direct IP Connection To Your Own Base Through GPRS Modem and RTDS Software

Introduction

Until recently, Direct IP connections from Ashtech rovers were possible only with third-party reference stations. Today, with the Ashtech RTDS¹ software, you can also have your own base transmitting its corrections to your rovers through a Direct IP connection.

In this configuration, the RTDS software serves as the relaying device between the base and the rovers. The presence of a relaying device is required because modems are assigned an IP address by the network when they connect to it, and this IP address cannot be known ahead of time for both modems. The RTDS software solves this problem by providing a fixed IP address through which that base and rover modems can communicate.

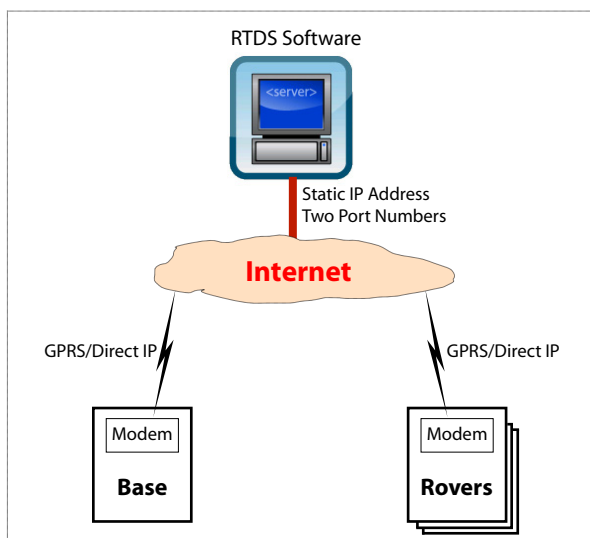

1. RTDS for Real Time Data Server

Software Requirements & Features

- The computer used to run the RTDS software is Internet-accessible through a **static IP address** and one or two port numbers.
- Several instances of the RTDS software can be run on the same computer, meaning the same computer can serve as data relay for several bases.
- Up to 100 rovers can receive data from a single instance of the RTDS software. All rovers communicate with a given instance of RTDS through the same port number.

Configuration Modes

The diagram below summarizes the possible two cases of use for the RTDS software with your system.

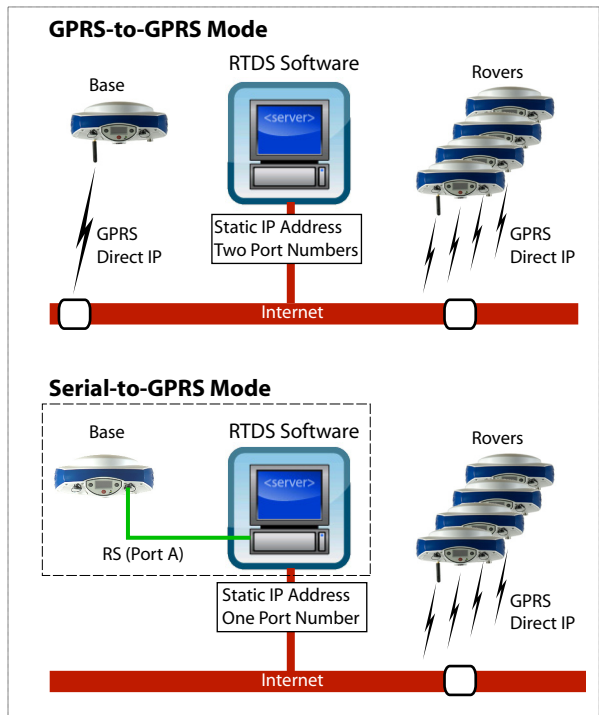

In Serial-to-GPRS mode, the base and the computer running RTDS are at the same location since a conventional RS232 serial line is used to connect one to the other.

Getting Started With RTDS

The implementation procedure can be outlined as follows:

1. You first need to know which IP address should be entered in your surveying system to establish a Direct IP connection to the RTDS software.

Unless you already have a static IP address, or if you don't know whether you have one or not, call your Internet Service Provider (ISP) to obtain a **static IP address** for the computer on which you will install the RTDS software.

With most ISPs, you'll have to pay a fee to get a static IP address option for your computer.

2. You then have to choose one or two **port numbers**, depending on whether you will be using the GPRS-to-GPRS or Serial-to-GPRS mode.

In theory, port numbers can range from 1 to 65536 but No. 1 to No. 1024 are considered as reserved numbers.

There are also conventions recommending the use of specific port numbers for specific applications. For example, all GNSS-related data exchanged on the Internet are usually routed through port 2101. This port number can then be chosen (plus others if necessary, for example, "2102", "2103", etc.), but remember that any numbers greater than 1024 may be chosen, provided they are not used on your computer for some other application.

3. Take the necessary steps to allow data to flow freely between RTDS and your surveying system through the chosen port number(s). This means you have to declare the use of this port (or these ports) in the ADSL modem firewall (or gateway), and possibly in the computer firewall. You may need some advice from your computer specialist to complete this operation.

If your computer is part of a local network (LAN), ask the network administrator to perform the required network address translations (NAT) and declare the port numbers used so the data arriving at the public IP address can be routed to your computer through its local IP address and port.

4. Install the RTDS software on your computer. This is an easy step during which you just have to run the "Ashtech Real Time Data Server x.x-x setup.exe" file provided, then follow the instructions to complete the installation phase.
5. Determine whether you need to use the GPRS-to-GPRS or Serial-to-GPRS mode (see above), depending on your application. Choose the base location and computer location accordingly.
6. On the computer, launch RTDS and make the appropriate settings (plus make the serial connection if the Serial-to-

GPRS mode is selected). See *RTDS on-line help* for more details.

7. Start the RTDS server and let the software run throughout your field survey, or permanently if you wish to set up a community base station.
8. Set the base in Direct IP mode so that it sends its corrections to the RTDS software. When defining the Direct IP connection, you need to enter:
 - The static IP address of the computer running the RTDS software.
 - The port number assigned to the base connection in the RTDS software (as entered in RTDS Software's **RTDS Config>Port Config>Base Port** field).

The RTDS operator will see the base-to-server arrow blink when corrections are received from the base. The IP address of the base will appear under the base icon. The incoming data throughput will be indicated just underneath the blinking arrow.

9. Set the rover in Direct IP mode in order to receive corrections from the RTDS software.
 - The static IP address of the computer running the RTDS software.
 - The port number assigned to the rover connection in the RTDS software (as entered in RTDS Software's **RTDS Config>Port Config>Rover Port** field).

On the rover side, wait until the data link icon appears on the front panel. When this happens, corrections are received and at least a float solution is available.

The RTDS operator will see the server-to-rover arrow start blinking when at least one rover queries the server for corrections. The outgoing data throughput is also indicated just underneath the blinking arrow.

Using a Background Map In FAST Survey

Preparing a Map File for Use as a Background Map in FAST Survey

Use your office computer and the Carlson Image X-Port.exe program to georeference a map before uploading it into your FAST Survey field terminal as a background map.

The Carlson Image X-Port.exe program can be downloaded for free from:

http://update.carlsonsw.com/kbase_main.php?action=display_topic&topic_id=477

After opening this web page, click on the “Carlson Image-Export.exe” link at the bottom of the page and save the file to your computer.

Follow the instructions below to prepare a map.

1. Create a new folder (e.g. “Maps”) on your computer, **necessarily in the “My Documents” folder.**
2. Copy the image file (e.g. “RFS20L.TIF”) you want to georeference to the new folder.
3. Run Carlson Image X-Port.exe.
4. Select **File>Open Image File**. Browse to the image file folder, and double-click the file name. This opens the map in the program window.

If necessary, use the **Zoom Level** drop-down menu to adjust the map zoom setting.

You can also use the **Tools>Image Brightness** function to make the map lighter or darker. **Important!** The resulting background map in FAST Survey will feature the same brightness.

5. Select **Tools>World File Editor**. This opens the World File Editor window in which you have to define the following parameters:

- **X Resolution:** Indicates the real distance represented by one pixel in the image file. It is obtained by making the ratio between the real distance represented by the total width of the map and the total number of pixels used horizontally. For example, the map width represents 200 meters and the number of pixels used is 1000, then X Resolution=0.2, which means one pixel represents a square of 20 cm.
- **Negative Y Resolution:** Usually equal to X Resolution with a minus sign placed before.
- **Amount of Translation, Amount of Rotation:** Keep the default value “0.0000” for these two parameters.
- **X Coordinate:** Easting of upper left corner of the map (pixel 1,1)
- **Y Coordinate:** Northing of upper left corner of the map (pixel 1,1)

Note that if the file was georeferenced earlier, all these parameters may have been saved in a *.tfw, *.jgw or *.bpw file. If that is the case, click on the **Import World Files** button, select the corresponding file and click **Open**. This

causes all the fields on the World File Editor window to be filled in from this file.

If there is not such a file, you have to work on finding georeferencing information for the map, as explained in *Determining Georeferencing Information for an Image File on page 133*.

6. After entering all the parameters in the World Map Editor window, click **OK** to close it.
7. Select **Image Database>Add Image to Database**. This opens the Add Images to Database window in which the program indicates that the original map is going to be split into several smaller map sections, each in BMP file format. The program indicates the number of files that will be created in the horizontal (columns) and vertical (row) directions. Depending on the extent of the original map, up to five different levels of image resolution may be created to match the different zoom settings in FAST Survey.
8. Click on the **Process** button and wait until the program has finished processing the original map. In the left column is an example of a map split into three smaller map sections arranged vertically (i.e. column=1; rows=3).
9. Click **OK** to close the window.
10. Click **File>Save as Image Database** and name the project file (e.g. "Map1"). This will be a text file gathering the georeferencing data of the map project as well as the paths and names of the different bmp files created through the above process step.
11. Click **Save** to save the different files of the map project to the folder created earlier ("Maps" in our example).
12. Click **File>Exit** to quit the program. If you now have a look into the "Maps" folder, you will see the following list of files (still referring to our example):
 - Map1.imd (map project description file)
 - A_RFS20Lr1c1.bmp (1st bitmap file, 1st row, 1st column),
 - A_RFS20Lr2c1.bmp (2nd bitmap file, 2nd row, 1st column),
 - A_RFS20Lr3c1.bmp (3rd bitmap file, 3rd row, 1st column).

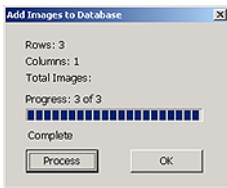





The naming convention used for the BMP files is the following:

- Prefix representative of the resolution of each file ("A_"= lower resolution; "F_"= higher resolution),

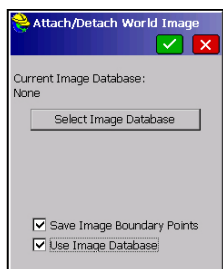
- Original file name re-used in the body of the filename,
- “rxcx” suffix to identify the row and column of the map section,
- File extension (bmp).

Enabling/Disabling a Background Map in FAST Survey



1. Create a new folder in the root directory of your field terminal's memory card. This folder must have the same name as the one created in “My documents” on the office computer (“Maps” in our example).
2. Copy the IMD file as well as the generated BMP files to that folder. You don't need to copy the original image file or the world file to the folder.
3. Remove the memory card from the office computer and insert it into your field terminal.
4. Run FAST Survey and start a new job.
5. Tap  in the upper-right corner of the screen.
6. Tap **TOOLS>Place World Image**.
7. Check on **Use Image Database** and **Save Image Boundary Points**.
8. Tap on the **Select Image Database** button and find the IMD file on the memory card.
9. Select the IMD file and tap  twice.
10. Tap  to adjust the zoom so the background map can now be seen.
If later on you wish to hide the background map, simply go back to **TOOLS>Place World Image** and clear the **Use Image Database** box.

Determining Georeferencing Information for an Image File

You may have no information at all that would allow you to quickly georeference the image file of your background map. In that case, you need to determine the following parameters (illustrated in the diagram below) to be able to georeference the image file:

1. **Real coordinates of points A (x1, y1) and B (x2, y2)**, and **horizontal distance (D)** between points A and B. Points A and B are arbitrary points well distributed horizontally on the image file and easy to spot both on the image file (map) and in the field.
2. **Real coordinates of point O (x0, y0)** located at the upper-left corner of the image file.
3. **Image width** expressed in pixels.

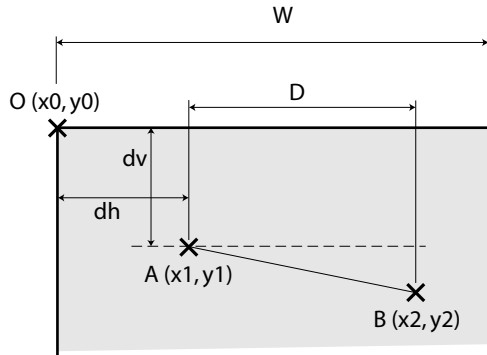

Determining Points A & B and Distance D

- Choose two points that can easily be spotted both on the image file and in the field.
- Go to the field and survey these two points with your surveying system. This immediately gives the coordinates x_1, y_1 and x_2, y_2 of points A and B respectively.
- From these coordinates, you can deduce D:

$$D = |x_2 - x_1|$$

Determining the Coordinates (x0, y0) of Point O

- Print out the image file using a high-quality printer.
- Using a graduated ruler, measure successively the lengths of D, dh and dv on the map printout.
- Assuming the obtained measurements are respectively D' , dh' and dv' , we have:

$$D / D' = dh / dh' = dv / dv'$$

This means the values of dv and dh can be determined as follows (make sure you use the same distance unit for all these distances):

$$dh = (D \times dh') / D' \text{ and } dv = (D \times dv') / D'$$

The (x0, y0) coordinates are then:

$$x_0 = x_1 - dh \text{ and } y_0 = y_1 + dv$$

x_0 and y_0 are the values you have to enter in the **X Coordinate** and **Y Coordinate** fields of the World File Editor window.

Reading the Image Width

- Still with the graduated ruler, measure the map width. Assuming W is the real distance in the field, then W' is the equivalent length measured on the map printout.
- Using Windows Explorer on your office computer, navigate to the folder containing the image file.
- Right-click on the filename and select **Properties** from the popup menu.
- On the **Summary** tab, click on the **Advanced** button (this may not be necessary if the advanced parameters are displayed by default).
- Read the number of pixels (P) displayed for the width parameter (see example on the left).

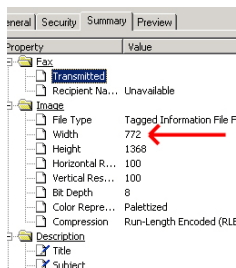

Computing the X Resolution

- Since we have:

$$W / W' = D / D'$$
- Then the value of the real distance W is:

$$W = (W' \times D) / D'$$
- And the X Resolution is finally equal to:

$$X \text{ Resolution} = W / P$$

The X Resolution is the value you have to enter in the **X Resolution** field of the World File Editor window. Enter this value as well in the **Negative Y Resolution** field, this time with a minus sign placed ahead.

Saving the Georeferencing Information

You can create an ASCII text file, using a simple text editor such as Microsoft Notepad, to save the parameters you have just determined. The file should be saved with the tfw, igw or bpw extension, depending on whether the original image file is respectively a TIF (or TIFF), JPG (or JPEG) or BMP file. The content of the ASCII text file should always be formatted as follows:

```
X Resolution (x.x)
Amount of Translation (x.xxx)
Amount of Rotation (x.xxx)
Y Resolution -x.x)
x0 coordinate (xxxxxx)
y0 coordinate (xxxxxx)
```

After saving the ASCII text file to the same folder as the original image file, you can come back to the procedure

described in *Preparing a Map File for Use as a Background Map in FAST Survey on page 130* to georeference your map and generate the corresponding BMP map sections used by FAST Survey.

Default Settings

This section describes the factory settings saved in the ProMark 800's permanent memory. (These default settings were pre-loaded into your receiver by running the appropriate set of serial commands.)

Wherever mentioned in this section, "M" and "U" ports refer to memories or files. "M" designates the internal memory, and "U" the external memory (USB mass storage device).

Serial Ports

Parameter	Range	Default
Port A baud rate	300 to 115200 Bd	19200 Bd
Port A RTS/CTS protocol	ON or OFF	ON
Port A mode	232, 422	232
Port D baud rate	300 to 115200	38400

Bluetooth

Parameter	Range	Default
Device name	64 characters max.	Serial number
PIN code	8 digits max.	-1 (no PIN code)

Modem

Parameter	Range	Default
Power management	Manual, Automatic	Manual
PIN code	8 digits max.	
Protocol	GPRS	GPRS
Network type	2G/3G auto or 2G	Auto
GPRS access point name	32 characters max.	
GPRS login	32 characters max.	
GPRS password	32 characters max.	
Internet protocol	TCP, UDP	TCP
Auto-dial mode	Yes, No	Yes
Number of re-dials	0-15	2
Watch dog	0-99	0
NTRIP IP address	xxx.xxx.xxx.xxx	

Parameter	Range	Default
NTRIP host name	32 characters max.	
NTRIP port number	0-65535	2100
NTRIP login	32 characters max.	
NTRIP password	32 characters max.	
NTRIP type	Client, Server	Client
Direct IP address (or host name)	xxx.xxx.xxx.xxx	0.0.0.0
Direct IP port number	0-65535	2100

Internal Radio (Port D)

Parameter	Range	Default
Radio type	UNKNOWN, NONE, ADL	
Power management	Manual, Automatic	Automatic

NMEA Messages, Computed Data

Parameter	Range	Default
Output rate	0.05 s - 999 s	1 s
Port A - xxx	ON, OFF	OFF
Port A - xxx rate	0.05 s - 999 s	1 s
Port C - xxx	ON, OFF	OFF
Port C - xxx rate	0.05 s - 999 s	1 s
Port E - xxx	ON, OFF	OFF
Port E - xxx rate	0.05 s - 999 s	1 s
Port M - xxx	ON, OFF	OFF
Port M - xxx rate	0.05 s - 999 s	1 s
Port U - xxx	ON, OFF	OFF
Port U - xxx rate	0.05 s - 999 s	1 s

xxx: NMEA message type ALM, DTM, GGA, GLL, GRS, GSA, GST, GSV, RMC, SGA, SGL, SGP, VTG, ZDA, CRT, DCR, DPO, LTN, POS, PTT, RRE, SAT or VEC.

NMEA Messages, Raw Data

Parameter	Range	Default
Output rate	0.05 s - 999 s	1 s
Port A - xxx	ON, OFF	OFF
Port A - xxx rate	0.05 s - 999 s	1 s
Port C - xxx	ON, OFF	OFF
Port C - xxx rate	0.05 s - 999 s	1 s
Port M - xxx	ON, OFF	OFF
Port M - xxx rate	0.05 s - 999 s	1 s

Parameter	Range	Default
Port U - xxx	ON, OFF	OFF
Port U - xxx rate	0.05 s - 999 s	1 s

xxx: NMEA message type MPC, DPC, PBN, SNV, SNG, SNW, SAG, SAL, SAW, SBD or ION.

Raw Data Logging

Parameter	Range	Default
Memory Storage location	Internal, External	Internal
Raw data recording mode	Yes, No	No
Raw data recording rate	0.05 s - 999 s	1 s
Site name	4 characters	The last four digits of the serial number

GNSS Reception

Parameter	Range	Default
SBAS use	ON, OFF	ON
GLONASS use	ON, OFF	ON
GALILEO use	ON, OFF	OFF

Note: Refer to \$PASHS,CFG and \$PASHS,GPS for more information on the frequencies received for each constellation.

Antenna Parameters

Parameter	Range	Default
Antenna reduction mode	OFF, ON, ARP	ON
Antenna height	0-6.553 m	0
Type of antenna height	Vertical, slant	Vertical

Position Computation

Parameter	Range	Default
Receiver mode	Rover, Base, Backup	Rover
Ambiguity fixing parameter	95.0, 99.0, 99.9	99.0
Fast RTK output mode	OFF, ON	ON
Rover dynamics	1-8	8
RTK network operation mode (GPS)	0-1	1
RTK network operation mode (GLONASS)	0-1	0

Parameter	Range	Default
Position elevation mask	0-90°	5°
Incoming differential data	Automatic, Manual	Automatic
Incoming differential port 1	A, C, D, E	
Incoming differential port 2	A, C, D, E	

Base

Parameter	Range	Default
Differential data type 1	NONE, ATM, RT2 (RTCM2.3), RT3 (RTCM3.x), CMR, CMR+, DBN	RT3
Differential data port 1	A, C, E, M, U	A
Differential data type 2	NONE, ATM, RT2 (RTCM2.3), RT3 (RTCM3.0), DBN (DBEN), CMR, CMR+	NONE
Differential data port 2	A, C, E, M, U	A
RTCM 2.3 type xxx rate*	0-300 s	Type 18: 1 s Type 19: 1 s Type 23: 31 s Type 24: 13 s Other: 0
RTCM 3.x type xxx rate**	0-300 s	Type 1004: 1 s Type 1006: 13 s Type 1012: 1 s Type 1033: 13 s
ATOM scenario xxx ***	0-1800 s	Scenario No.: 4 Observations: 1 s Attributes: 31 s
CMR station ID	0-31	1
RTCM2.3 station ID	0-1023	1
RTCM3.x station ID	0-4095	1
CMR type 0 rate	0, 0.5 s, 1-300 s	1 s
CMR type 1 rate	0-300 s	30 s
CMR type 2 rate	0-300 s	30 s
CMR type 3 rate	0, 0.5 s or 1-300 s	1 s
Base position (lat, lon, height)		0°, 0°, 0 m
Elevation mask	0-90 degrees	5 degrees

*: Message type 1, 3, 9, 16, 18, 20, 22, 23, 24, 31, 32, 34 or 36.

** : Message type 1001, 1002,.. 1013, 1019, 1020, 1029 or 1033.

***: Message scenario 1-4, 100, 101, 201-204 or 300.

Other Settings

Parameter	Range	Default
Minimum battery level	6.7 - 8.4 V DC	6.8
Minimum external DC level	9.0 - 28.0 V DC	9.1
Local time zone, hours	-13 to +13	0
Local time zone, minutes	0-59	0
Beeper state	ON, OFF	ON
RTC Bridge	ON, OFF	OFF
VRS	Automatic, Compulsory	Automatic
Generating log files automatically	Enabled, disabled	Enabled, 1 Mbyte size limit, saved for 10 days
Auto-dial mode	Yes, No	Yes
1 PPS	OFF-ON	OFF
Dynamic model	0-100000 m/s velocity 0-100 m/s ² acceleration	Hor. & vert. velocity: 100000m/s; Hor. & vert acceleration: 100 m/s ²

**ProMark 800
Serial Commands
& Data Outputs
Supplement**



Appendix A. Using Serial Commands



Introduction to Serial Commands

Serial commands allow you to communicate directly with the receiver in its proprietary command language. Serial commands can be used for various purposes such as:

- Changing default settings
- Monitoring different receiver statuses (internal operation, constellations, etc.)
- Outputting messages on request

Serial commands fall into two categories:

- *Set* commands (\$PASHS,...), used to set or modify the receiver's internal parameters.
- *Query* commands (\$PASHQ,...), used to interrogate the receiver.

The few conventions used to describe the serial commands in this manual are summarized in the table below.

String or sign	Description
\$PASHS	Header for set commands (Whole line shown in bold characters)
\$PASHQ	Header for query commands (Whole line shown in bold characters)
\$PASHR	Receiver response line, in normal characters.
\$-	Header prefix for all standard NMEA messages delivered by the receiver.
[]	Optional field or parameter
,	Field delimiter
.	Decimal point (used in f-type fields)
c..	One-character string
d..	Integer
f..	Real number, with decimal places
h..	Parameter in hexadecimal notation
m..	Denotes specific data format used, such as angles (e.g. ddm.ddd) or time (e.g. hhmmss.sss)

String or sign	Description
n	Used in the syntax of responses to query commands to indicate that a sequence of parameters will be repeated “n” times in the response. For example, n(f1,f2,f3) means the response will include the sequence “f1,f2,f3,f1,f2,f3,f1,f2,f3...”. The value of n is specific to each command.
s..	Character string
*cc	Checksum

In response to a well recognized and properly executed set command, the receiver will return the message:

```
$PASHR,ACK*3D
```

A set command is said to be “NAKed” when it is not accepted or acknowledged. The following message is then returned:

```
$PASHR,NAK*30
```

If this happens, check that the command has been typed correctly and the number and format of parameters are correct. In some cases, the execution of a set command may be contingent upon the prior activation of the corresponding firmware option.

Checksum Calculation: The checksum is computed by “exclusive-ORing” all of the bytes in the message between, but not including, the “\$” and the “*”. The result is “*hh” where h is a hexadecimal character.

Applying Commands Through Bluetooth or a Serial Port

From the Office Computer

Use GNSS Solutions’ WinComm utility, or any terminal emulation program such as HyperTerminal (a standard Windows communication accessory), to send serial commands to the receiver.

Interfacing the chosen program with the receiver is achieved by establishing a connection through one of the computer’s COM port (a serial data cable is then required), or using Bluetooth if this device is available on the computer.

For more information on WinComm, see *GNSS Solutions Reference Manual* or WinComm On-Line Help.

When using HyperTerminal, perform the following settings after creating a new connection (serial ports on Ashtech receivers are usually set as follows: 19200 Bd, 8 data bits, 1

stop bit, no parity, no flow control), and before typing your first command:

- In the HyperTerminal menu bar, select **File>Properties**.
- Click on the **Settings** tab.
- Click on the **ASCII Setup** button.
- Enable the following two options: **Send line ends with line feeds** and **Echo typed characters locally**. This will automatically complete all your command lines with <cr><lf> characters and allow you to see in real time the commands you are typing.
- Click **OK** twice to close the Properties window.

From FAST Survey

From the FAST Survey menu, tap on the **Equip** tab, then on the **GPS Utilities** button, and then on the **Send Command** button. It is assumed that the communication with the receiver has been established via Bluetooth or a serial cable.

Running a Single Command at a Time

- Tap your command directly in the combo box using FAST Survey's virtual keyboard. The keyboard appears automatically when you tap inside the box.
- Tap after you have typed the command line.
- Tap on the **Send** button to send the command to the receiver. The command line as well as the response line(s) then appear at the bottom of the screen.



Running a Series of Commands

First of all, you need to create a TXT file containing all the commands you want the receiver to run. Save the file to the "MyDevice/FAST Survey/Data/" folder. Then do the following:

- Use the **Send File** button in the upper part of the window to select the TXT file and send it to the receiver.
- Once the receiver has executed all the commands included in the file, a new window is displayed listing each of the commands run in the receiver as well the resulting receiver response line(s).
- Tapping will take you back to the command window.

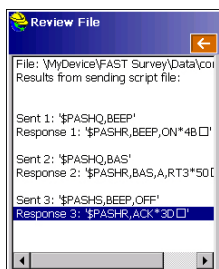

Running Serial Commands from a USB Key

Serial commands can also be run from a USB key you connect to the receiver's USB port through the dedicated cable.

What you have to do is create a text file containing the list of serial commands you would like the receiver to execute.

In this file can also be inserted the \$PASHS,CMD,WTI command, which is used to introduce an idle time before the receiver is allowed to execute the command that comes after. After typing the last command in the file, press the ENTER key to insert a carriage return + line feed as the last item in the file. This is mandatory.

Then you just have to copy the file to the USB key's root directory.

The receiver will always execute the list of commands (the *script*) in the given order, except for some commands like \$PASHS,REC and \$PASHS,INI, which are necessarily run last.

Starting the execution of the script may be done in two different ways:

- **Automatically:** The receiver will automatically prompt you to run the script when you connect the USB key to the receiver. This is achieved by simply naming the file "autoconfig.cmd"
- **Manually:** This is achieved by naming the file differently and using the \$PASHS,CMD,LOD command to initiate the execution of the script.

Described below is the typical procedure to make the receiver run automatically a series of commands stored on a USB key under a file named "autoconfig.cmd":

- Connect the USB key to the receiver.

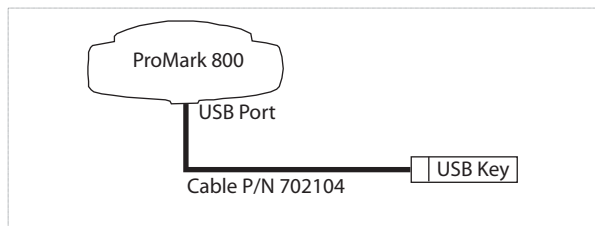

- Wait until the USB logo appears on the receiver screen and a message is prompted (**Upload Script?**).

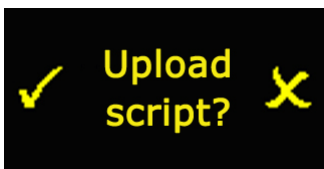

- Accept the request by pressing the Log button (you could reject it by pressing the Scroll button). The receiver will then start executing the script of commands. This is indicated on the display screen where you can see the number of commands to be run (on the right) and the rank of the command being currently run (on the left). In the example below, the receiver is running the 1st command of the 18 ones it has to go through:

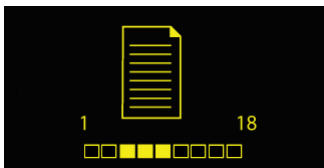

- When all the commands have been run, the receiver comes back to the screen it was displaying before.
- Remove the USB key.
- You can now have a check on how the receiver ran each of the commands: Connect the USB key to a computer and edit the `autoconfig.log` file created on the USB key by the receiver while executing the commands. Each correctly executed command is followed by:

```
$PASHR,ACK*3D
```

List of Commands

The two categories of commands (set/query) are combined in a single table. Commands appear in alphabetical order. All

pairs of related set and query commands (e.g. \$PASHS,ANH and \$PASHQ,ANH) always appear in the same row.

Table 1. Receiver Configuration Commands

Set Command	Description	Query Command	Description
\$PASHS,AGB	Adjusting GLONASS biases	\$PASHQ,AGB	GLONASS biases
\$PASHS,ANH	Antenna height	\$PASHQ,ANH	Antenna height
\$PASHS,ANP,..	Antenna definitions	\$PASHQ,ANP	Antenna parameters
\$PASHS,ANP,DEL	Deleting user-defined antennas		
\$PASHS,ANP,OUT	Virtual antenna	\$PASHQ,ANP,OUT	Virtual antenna
		\$PASHQ,ANP,OWN	Local antenna name
		\$PASHQ,ANP,RCV	Antenna Name & Offsets of Received Base
\$PASHS,ANP,REF	Reference antenna	\$PASHQ,ANP,REF	Reference antenna
\$PASHS,ANR	Antenna reduction mode	\$PASHQ,ANR	Antenna reduction mode
\$PASHS,ANT	Antenna height	\$PASHQ,ANT	Antenna height
\$PASHS,ATL	Debug data recording	\$PASHQ,ATL	Debug data recording
\$PASHS,ATM	ATOM messages	\$PASHQ,ATM	ATOM data parameters
\$PASHS,ATM,ALL	Disable ATOM messages		
\$PASHS,ATM,PER	ATOM output rate		
\$PASHS,ATM,VER	Set Version of ATOM Messages		
		\$PASHQ,ATO	ATOM message parameters
\$PASHS,BAS	Differential data type	\$PASHQ,BAS	Differential data type
\$PASHS,BEEP	Beeper	\$PASHQ,BEEP	Beeper
\$PASHS,BRD	RTC Bridge	\$PASHQ,BRD	RTC Bridge
		\$PASHQ,BTH	Bluetooth settings
\$PASHS,BTH,NAME	Bluetooth device name		
\$PASHS,BTH,PIN	Bluetooth device pin code		
\$PASHS,CFG	GNSS tracking configuration	\$PASHQ,CFG	GNSS tracking configuration
\$PASHS,CMD,LOD	Run command file		
\$PASHS,CMD,WTI	Insert wait time in command file		
		\$PASHQ,CMR,MSI	CMR message status
\$PASHS,CMR,TYP	CMR message type & rate		
\$PASHS,CPD,AFP	Set confidence level	\$PASHQ,CPD,AFP	Ambiguity fixing parameter
\$PASHS,CPD,FST	RTK output mode	\$PASHQ,CPD,FST	RTK output mode
\$PASHS,CPD,MOD	Base/rover mode	\$PASHQ,CPD,MOD	Base/rover mode
\$PASHS,CPD,NET	Network corrections	\$PASHQ,CPD,NET	Network operation mode
\$PASHS,CPD,REM	Differential data port	\$PASHQ,CPD,REM	Differential data port
\$PASHS,CPD,RST	RTK process reset		
\$PASHS,CPD,VRS	VRS assumption mode	\$PASHQ,CPD,VRS	VRS assumption mode
\$PASHS,CTS	Handshaking	\$PASHQ,CTS	Handshaking
		\$PASHQ,DBN,MSI	DBEN message type & rate
\$PASHS,DBN,TYP	DBEN message type & rate		
\$PASHS,DIP		\$PASHQ,DIP	Direct IP parameters
\$PASHS,DIP,OFF	Direct IP connection		
\$PASHS,DIP,ON	Direct IP connection		
\$PASHS,DIP,PAR	Direct IP parameters		

Table 1. Receiver Configuration Commands (Continued)

Set Command	Description	Query Command	Description
\$PASHS,DRI	Raw data recording rate	\$PASHQ,DRI	Raw data recording rate
\$PASHS,DSY	Daisy chain mode	\$PASHQ,DSY	Daisy chain mode
\$PASHS,DYN	Receiver dynamics	\$PASHQ,DYN	Receiver dynamics
\$PASHS,ELM	Elevation mask	\$PASHQ,ELM	Elevation mask
		\$PASHQ,FIL,CUR	G-File information
\$PASHS,FIL,D	Deleting files		
\$PASHS,FIL,DEL	Deleting files and directories		
		\$PASHQ,FIL,LST	List of files
		\$PASHQ,FLS	List of raw data files
\$PASHS,GAL	GALILEO Tracking	\$PASHQ,GAL	GALILEO Tracking
\$PASHS,GLO	GLONASS tracking	\$PASHQ,GLO	GLONASS tracking
\$PASHS,GPS	GPS tracking	\$PASHQ,GPS	GPS tracking
\$PASHS,INI	Receiver initialization		
\$PASHS,LCS	Enable/disable local datum	\$PASHQ,LCS	Local datum
		\$PASHQ,LOG	Editing a log file
\$PASHS,LOG,DEL	Deleting log files		
		\$PASHQ,LOG,LST	Listing log files
\$PASHS,LOG,PAR	Log file settings	\$PASHQ,LOG,PAR	Log file settings
\$PASHS,LTZ	Time zone		
		\$PASHQ,MDM	Modem status and parameters
\$PASHS,MDM,INI	Initializing the modem		
		\$PASHQ,MDM,LVL	Modem signal level
\$PASHS,MDM,OFF	Internal modem power off		
\$PASHS,MDM,ON	Internal modem power on		
\$PASHS,MDM,PAR	Setting modem parameters		
		\$PASHQ,MDM,STS	Modem status
\$PASHS,MDP	Port A setting	\$PASHQ,MDP	Port A setting
\$PASHS,MEM	Memory device used	\$PASHQ,MEM	Memory device used
\$PASHS,MWD	Modem timeout	\$PASHQ,MWD	Modem timeout
\$PASHS,NME	NMEA messages (ON/OFF)		
\$PASHS,NME,ALL	Disabling all NMEA messages		
\$PASHS,NME,PER	NMEA output rate		
		\$PASHQ,NMO	NMEA output settings
\$PASHS,NPT	Tag SBAS Diff Positions in NMEA and NMEA-Like Messages	\$PASHQ,NPT	Tagging of SBAS Diff Positions in NMEA and NMEA-Like Messages
		\$PASHQ,NTR	NTRIP settings
\$PASHS,NTR,LOD	Loading NTRIP source table		
\$PASHS,NTR,MTP	Connect to NTRIP mount point	\$PASHQ,NTR,MTP	Current mount point
\$PASHS,NTR,PAR	NTRIP settings		
		\$PASHQ,NTR,TBL	Source table
\$PASHS,OCC	Writing occupation data	\$PASHQ,OCC	Occupation state and parameters
\$PASHS,OPTION	Receiver firmware options	\$PASHQ,OPTION	Receiver firmware options
		\$PASHQ,PAR	Receiver parameters

Table 1. Receiver Configuration Commands (Continued)

Set Command	Description	Query Command	Description
\$PASHS,PAR,LOD	Configure receiver from PAR File		
\$PASHS,PAR,SAV	Save receiver config to PAR File		
\$PASHS,PEM	Position elevation mask	\$PASHQ,PEM	Position elevation mask
\$PASHS,POP	Internal update rates	\$PASHQ,POP	Internal update rates
\$PASHS,POS	Antenna position		
\$PASHS,PPS	1 PPS properties	\$PASHQ,PPS	1 PPS properties
\$PASHS,PRT	Baud rates	\$PASHQ,PRT	Baud rates
\$PASHS,PWR,OFF	Powering off the receiver		
\$PASHS,PWR,PAR	Power management	\$PASHQ,PWR	Power status
\$PASHS,RAW	Raw data messages (ON/OFF)	\$PASHQ,RAW	Raw data settings
\$PASHS,RAW,ALL	Disabling all raw data messages		
\$PASHS,RAW,PER	Raw data output rate		
\$PASHS,RCP,GB..	GLONASS biases		
		\$PASHQ,RCP	Receiver parameters
\$PASHS,RCP,DEL	Delete user-defined rec. name		
		\$PASHQ,RCP,OWN	Receiver name
\$PASHS,RCP,REF	Naming reference receiver	\$PASHQ,RCP,REF	Reference receiver name
		\$PASHQ,RDP,CHT	Radio channel table
		\$PASHQ,RDP,LVL	Radio reception level
\$PASHS,RDP,OFF	Powering off internal radio		
\$PASHS,RDP,ON	Powering on internal radio		
\$PASHS,RDP,PAR	Setting the radio	\$PASHQ,RDP,PAR	Radio parameters
\$PASHS,RDP,TYP	Radio type used	\$PASHQ,RDP,TYP	Radio type used
\$PASHS,REC	Raw data recording	\$PASHQ,REC	Raw data recording
		\$PASHQ,RID	Receiver identification
\$PASHS,RNX,TYP	ATOM RNX message		
		\$PASHQ,RNX,MSI	ATOM RNX message
\$PASHS,RST	Default settings		
		\$PASHQ,RTC	RTCM status
\$PASHS,RTC,MSG	User message		
		\$PASHQ,RTC,MSI	RTCM messages status
\$PASHS,RTC,TYP	RTCM message type		
		\$PASHQ,RWO	Raw data output settings
\$PASHS,SBA	SBAS tracking (ON/OFF)	\$PASHQ,SBA	SBAS tracking status
\$PASHS,SIT	Site name	\$PASHQ,SIT	Site name
\$PASHS,SNM	Signal/noise ratio mask (PVT)	\$PASHQ,SNM	Signal/noise ratio mask (PVT)
\$PASHS,SOM	Masking signal observations	\$PASHQ,SOM	Masking signal observations
\$PASHS,SOM,CTT	Cumulative tracking time mask	\$PASHQ,SOM,CTT	Cumulative tracking time mask
\$PASHS,SOM,NAV	Navigation data mask	\$PASHQ,SOM,NAV	Navigation data mask
\$PASHS,SOM,SNR	Signal-to-Noise ratio mask	\$PASHQ,SOM,SNR	Signal-to-Noise ratio mask
\$PASHS,SOM,WRN	Channel warnings mask	\$PASHQ,SOM,WRN	Channel warnings mask

Table 1. Receiver Configuration Commands (Continued)

Set Command	Description	Query Command	Description
\$PASHS,STI	Station ID	\$PASHQ,STI	Station ID
\$PASHS,SVM	No. of observations in PVT	\$PASHQ,SVM	No. of observations in PVT
\$PASHS,UDP	User-defined dynamic model	\$PASHQ,UDP	User-defined dynamic model
\$PASHS,UNT	Distance unit on display screen	\$PASHQ,UNT	Distance unit on display screen
\$PASHS,UTS	Synchronization with GPS time	\$PASHQ,UTS	Synchronization with GPS time
\$PASHS,VEC	Set vector output mode		
		\$PASHQ,VERSION	Firmware version
\$PASHS,WAK	Alarm acknowledgement		
		\$PASHQ,WARN	Warning messages
\$PASHS,ZDA	Time and date		

Table 2. Data Output Commands

Set Command	Description	Query Command	Description
		\$PASHQ,ALM	Almanac message
		\$PASHQ,CPD,ANT	Base antenna height
		\$PASHQ,CPD,POS	Base position
		\$PASHQ,CRT	Cartesian coordinates of position
		\$PASHQ,DCR	Cartesian coordinates of baseline
		\$PASHQ,DDS	Differential decoder status
		\$PASHQ,DPO	Delta position
		\$PASHQ,DTM	Datum Reference
		\$PASHQ,GGA	GNSS position message
		\$PASHQ,GLL	Geographic position-lat./long.
		\$PASHQ,GNS	GNSS fix data
		\$PASHQ,GRS	GNSS range residuals
		\$PASHQ,GSA	GNSS DOP & active satellites
		\$PASHQ,GST	GNSS pseudorange error statistics
		\$PASHQ,GSV	GNSS satellites in view
		\$PASHQ,POS	Computed position data
		\$PASHQ,PTT	PPS time tag
		\$PASHQ,RMC	Recomm. min. specific GNSS data
		\$PASHQ,RRE	Residual error
		\$PASHQ,SAT	Satellites status
		\$PASHQ,SGA	GALILEO Satellites status
		\$PASHQ,SGL	GLONASS Satellites status
		\$PASHQ,SGP	GPS & SBAS Satellites status
		\$PASHQ,VEC	Vector & accuracy data
		\$PASHQ,VTG	COG and ground speed
		\$PASHQ,ZDA	Time and date



Appendix B. Set Command Library



AGB: Enabling/Disabling GLONASS Bias Adjustments

Function This command is used to enable or disable the adjustment of L1 & L2 GLONASS carrier biases in the receiver so that the GLONASS Double-Difference carrier residuals between the receiver and the *golden Ashtech receiver* are equal to zero (\pm noise errors).

MB 500 is considered as the golden Ashtech receiver.

After activating the adjustment function, the receiver name provided by any message supposed to deliver that name (e.g. RTCM-3 MT 1033) will appear in the form:

```
ASHTECH<space><name>
```

Where <space> is a space character between the two words and <name> is the receiver name entered through the \$PASHS,RCP,OWN command.

Command Format **Syntax**

```
$PASHS,AGB,s1[*cc]
```

Parameters

Parameter	Description	Range	Default
s1	Enabling (ON) or disabling (OFF) adjustment of GLONASS biases	ON, OFF	OFF
*cc	Optional checksum	*00-*FF	

Example

Enabling adjustment of GLONASS biases:

```
$PASHS,AGB,ON*1C
```

ANH: Antenna Height

Function This command allows you to enter the antenna height . If not specified, the height measurement type is set to “Vertical”.

Command Format Syntax
\$PASHS,ANH,f1[,c2][*cc]

Parameters

Parameter	Description	Range
f1	Antenna height.	0-6.553 m
c2	Antenna height measurement type: <ul style="list-style-type: none"> • V: Vertical measurement • S: Slant measurement 	V, S
*cc	Optional checksum	*00-*FF

Examples

Entering the vertical measurement (2 m) of a rover antenna:

\$PASHS,ANH,2.000

Entering the slant measurement (1.543 m) of a base antenna:

\$PASHS,ANH,1.543,S

Relevant Query Command \$PASHQ,ANH

See also \$PASHS,ANR

ANP,PCO & ANP,EDx: Creating/Editing Antenna Definitions

Function These commands allow you to create or modify antenna definitions. The definition of an antenna includes a name for the antenna, all its phase center offsets as well as the elevation-dependent delays (in 5-degree steps).

Command Format Syntax
\$PASHS,ANP,PCO,s1,f2,f3,f4,f5,f6,f7[*cc]
\$PASHS,ANP,ED1,s1,f2,f3,f4,f5,f6,f7,f8,f9,f10,... ,f19,f20[*cc]
\$PASHS,ANP,ED2,s1,f2,f3,f4,f5,f6,f7,f8,f9,f10,... ,f19,f20[*cc]

Parameters

ANP,PCO (PCO for Phase Center Offsets)

Parameter	Description	Range
s1	Antenna name	31 characters max.
f2	L1 phase center offset, in mm, in the North direction	±0-1000.0
f3	L1 phase center offset, in mm, in the East direction	±0-1000.0
f4	L1 phase center offset, in mm, in the vertical direction	±0-1000.0
f5	L2 phase center offset, in mm, in the North direction	±0-1000.0
f6	L2 phase center offset, in mm, in the East direction	±0-1000.0
f7	L2 phase center offset, in mm, in the vertical (up) direction	±0-1000.0
*cc	Optional checksum	*00-*FF

ANP,EDx (EDx for L1 and L2 Elevation Dependent delays)

Parameter	Description	Range
s1	Antenna name	31 characters max.
f2-f20	Elevation-dependant delays, in mm, for elevations from 90 to 0 degrees, in 5-degree steps.	±0-1000.0
*cc	Optional checksum	*00-*FF

Examples

Setting the PCO parameters for antenna ASH8987:

```
$PASHS,ANP,PCO,ASH8987,0,0,110,0,0,128*29
```

Setting the L1 delays for antenna MYANTENNA:

```
$PASHS,ANP,ED1,MYANTENNA,0,-2,0,-1.5,1,1.2,0,0,0,1,1,-1,0,1.2,-1.2,0,1,0*49
```

Relevant Query Command \$PASHQ,ANP

See also \$PASHS,ANP,DEL

ANP,DEL: Delete User-Defined Antenna

Function This command allows you to delete the definition of a user-defined antenna.

Command Format Syntax`$PASHS,ANP,DEL,s1[*cc]`**Parameters**

Parameter	Description	Range
s1	User-defined antenna name (case-sensitive)	31 characters max.
*cc	Optional checksum	*00-*FF

Example

Deleting RZ510A antenna definition:

`$PASHS,ANP,DEL,RZ510A*1A`**Relevant Query Command**`$PASHQ,ANP`**See Also**`$PASHS,ANP,PCO``$PASHS,ANP,ED1``$PASHS,ANP,ED2`**ANP,OUT: Defining a Virtual Antenna**

Function

This command allows you to specify the name of an antenna that raw data will be adjusted to. By specifying the name of a virtual antenna, you ask the receiver to correct (“reduce”) the raw and differential data it generates from the received GNSS signals to make them available as if they had been received through *that* antenna.

Command Format Syntax`$PASHS,ANP,OUT,s1[*cc]`**Parameters**

Parameter	Description	Range
s1	Virtual antenna name (case-sensitive) or “OFF” to specify that no virtual antenna is used.	31 characters max. or OFF
*cc	Optional checksum	*00-*FF

Examples

Setting the ADVNULLANTENNA as the virtual antenna:

\$PASHS,ANP,OUT,ADVNULLANTENNA*73

Disabling the use of the virtual antenna:

\$PASHS,ANP,OUT,OFF*2B

Comments

- Raw data reduction will not be performed on data from any satellite located below the elevation mask.
- When raw data reduction is effective, any antenna name messages generated by the receiver will include the name of the virtual antenna, and not the antenna serial number or the setup ID.
- If no reference position has been entered in the receiver, raw data reduction is performed in such a way that the location of the L1 phase center is left unchanged.
- Antenna reduction is performed in such a way that the ARP is unchanged. If the reference position is given with respect to the ARP, and not to the L1 phase center, then the receiver computes the position of the ARP using the physical parameters of the antenna, and then re-computes the position of the L1 phase center according to the ANP,OUT antenna parameters. This guarantees that the reported reference position, the antenna name and the observables are all consistent with one another.

Relevant Query Command \$PASHQ,ANP

ANP,REF: Naming the Antenna Used at the Base

Function This command is used to enter the name of the antenna used by the base with which the receiver is working.

Command Format Syntax
\$PASHS,ANP,REF,s1[,d2][*cc]

Parameters

Parameter	Description	Range	Default
s1	User-defined antenna name (case-sensitive).	31 characters max.	UNKNOWN
d2	Antenna name preference: <ul style="list-style-type: none"> • 0: s1 is ignored if a base antenna name is decoded from the incoming reference data. • 1: s1 is always used regardless of whether a base antenna name is decoded from the incoming reference data or not. 	0, 1	0
*cc	Optional checksum	*00-*FF	

Comments

- Specifying the antenna name allows the receiver to know the antenna offset parameters using the predefined list. In the receiver, the predefined parameters can be listed using \$PASHQ,ANP. New offset parameters can be added using \$PASHS,ANP,PCO.
- The predefined list complies with the IGS antenna source table.

Example

Entering “MAG990596” as the name of the base antenna:
\$PASHS,ANP,REF,MAG990596*3A

Relevant Query Command \$PASHQ,ANP
 \$PASHQ,ANP,REF

See Also \$PASHS,ANP,OWN

ANR: Antenna Reduction Mode

Function This command allows you to set the antenna reduction mode. The default value is ON.

Command Format Syntax
\$PASHS,ANR,s1[*cc]

Parameters

Parameter	Description	Range
s1	Antenna reduction mode: <ul style="list-style-type: none"> • OFF: No antenna reduction. The receiver ignores the antenna parameters entered via \$PASHS, ANH or \$PASHS,ANT. The computed position is that of the antenna's L1 phase center. This implies that the entered position for the base should also be that of its antenna's L1 phase center • ON: Antenna reduction is active (default). From the parameters entered through the \$PASHS, ANH or \$PASHS,ANT command, the position computed for the L1 phase center is projected to the ground thus making this point (ground mark) the real location of the rover. This implies that the entered position for the base should also be that of its ground mark. • ARP: The receiver ignores the antenna parameters entered via \$PASHS,ANH or \$PASHS,ANT. The computed position represents the location of the ARP. This implies that the entered position for the base should also be that of its antenna's ARP. 	OFF, ON, ARP
*cc	Optional checksum	*00-*FF

Example

Setting the antenna reduction mode to ON:

```
$PASHS,ANR,ON*05
```

Relevant Query Command \$PASHQ,ANR

See also \$PASHS,ANH
 \$PASHS,ANT

ANT: Antenna Height

Function This command is used to define the antenna height, especially when it was determined using the slant measurement method. However, a vertical measurement can also be entered through this command.

Using the \$PASHS,ANT command overwrites all previous settings performed with the \$PASHS,ANH command.

Command Format Syntax

\$PASHS,ANT,f1,f2,f3[,m4,f5][*cc]

Diagrams and Definitions

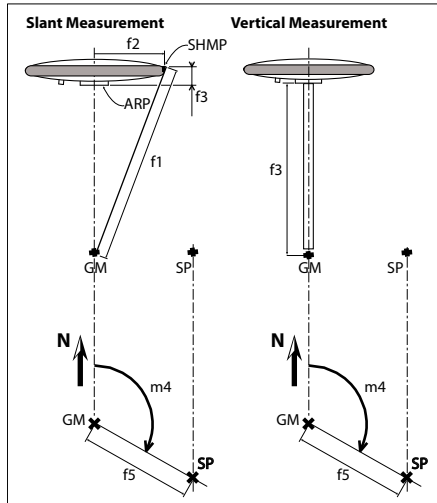

- ARP: Antenna Reference Point (usually bottom of the antenna).
- SHMP: Slant Height Measurement Point (usually at the hedge of the antenna, above the ARP).
- Ground Mark (GM): above the ARP (same horizontal coordinates).
- Survey Point (SP): same height as Ground Mark but with a horizontal offset.

Parameters

Parameter	Description	Range
f1	Slant height measurement, from ground mark (GM) to antenna edge (SHMP).	0-6.553 m
f2	Antenna radius: horizontal distance from the geometrical center to the antenna edge.	0-6.553 m
f3	Vertical offset: <ul style="list-style-type: none"> From ARP to SHMP, if radius and slant height are not null. From Ground Mark to ARP, if radius and slant height are null. 	0 to ±6.553 m
m4	Horizontal azimuth [dddmm.mm], in degrees, for the horizontal line connecting the ground mark (GM) to the surveyed point (SP), measured with respect to WGS84 North.	0-35959.99 (from 0° to 359° 59.99")
f5	Horizontal offset from the ground mark (GM) to the surveyed point (SP).	0-6.553 m
*cc	Optional checksum	*00-*FF

Examples

Entering the vertical measurement (2 m) of a rover antenna:

```
$PASHS,ANT,0,0,2.000*2E
```

Entering the slant measurement (1.543 m) of the ASH802147 antenna used at a base:

```
$PASHS,ANT,1.543,0.0980,-0.0400*07
```

Comments

- The vertical height from ARP to ground mark can also be entered through the ANT command, which in this case should be used as follows:
 - Set **f1** and **f2** to “0.0”
 - Enter the antenna height from ARP to ground mark as **f3**. Only when **f1=f2=0.0** can you define **f3** this way.
 - **f3** is negative when the ARP is below the SHMP.
- Parameters **m4** and **f5** are currently NOT processed in the ProMark 800.
- Using this command is not recommended to enter a slant height in the ProMark 800 for which **f2** and **f3** are hard-coded (**f2**=0.098 m and **f3**= -0.04 m).

Relevant Query Command

```
$PASHQ,ANT
```

See Also \$PASHS,ANH
\$PASHS,ANR

ATL: Debug Data Recording

Function This command allows you to enable or disable the recording of debug data. The resulting log file (called “ATL file”) is saved to the memory selected through the \$PASHS,MEM command. The file is named as follows:

ATL_yymmdd_hhmmss.log

Normally you don’t have to record debug data. However, the Ashtech Technical Support may ask you to do so if a problem occurs in your receiver and Technical Support needs to analyze the resulting log file to fix the problem. The content of this file can only be analyzed by Ashtech as it uses a proprietary, undisclosed data format, which in addition is subject to change without notice.

Command Format **Syntax**

\$PASHS,ATL,s1[,d2][,f3][,d4][*cc]

Parameters

Parameter	Description	Range	Default
s1	Controls debug data recording: <ul style="list-style-type: none"> • ON: Enables debug data recording • OFF: Disables debug data recording • AUT: Automatically starts debug data recording every time the receiver is turned on. 	ON, OFF, AUT	OFF
d2	Recorded data: <ul style="list-style-type: none"> • 0: Only \$ATL messages from GNSS board to system board • 1: Only those from system board to GNSS board • 2: All data exchanged between GNSS board and system board 	0-2	0
f3	Output interval, in seconds	0.05, 0.1, 0.2, 0.5, 1	1
d4	Configuration index	0-1	0
*cc	Optional checksum	*00-*FF	

Example

Enabling the ATL message:

```
$PASHS,ATL,ON*01
```

Comment

- If the memory selected through \$PASHS,MEM is unavailable, then “ACK” is returned in response to the command enabling recording (ON or AUT), prompting you to read the status of the debug data recording using the \$PASHQ,ATL command.

Relevant Query Command

```
$PASHQ,ATL
```

See Also

```
$PASHS,MEM
```

ATM: Enabling/Disabling ATOM Messages

Function

This command allows you to enable or disable ATOM messages on the specified port.

Command Format

Syntax

```
$PASHS,ATM,s1,c2,s3[,f4][*cc]
```

Parameters

Parameter	Description	Range
s1	ATOM message type	PVT, ATR, NAV, DAT, EVT, RNX. See table below.
c2	Port routing the ATOM message: <ul style="list-style-type: none"> • A: Serial port • C: Bluetooth port • E: Modem • M, U: Internal memory (U), USB key (U) • R: Automatic recording session (internal or external memory) 	A, C, E, M, R, U
s3	Enable (ON) or disable (OFF) this ATOM message type.	ON, OFF
f4	Output rate, in seconds. (Default value is specific to each message type.)	0.05 or 0.1-0.4 sec with [F] option activated. 0.5-0.9 s 1-999 s
*cc	Optional checksum	*00-*FF

ATOM Messages:

Data	ATOM Number	Description	Default Output Status on Port A	Default Output Status on Ports M, U and R
PVT	4095,3	Positioning results	OFF	OFF
ATR	4095,4	Receiver attributes	OFF	ON
NAV	4095,5	GNSS navigation data	OFF	ON, at 300 seconds
DAT	4095,6	Raw GNSS data: <ul style="list-style-type: none"> • GPS Raw Subframe (DAT, GPS) • GLONASS Raw String (DAT, GLO) • SBAS Subframe (DAT, SBA) 	OFF	OFF (no output rate)
EVT	4095,14	Event	OFF	OFF
RNX	4095,7 Scenario 0	GNSS raw measurementst	OFF	ON, at 1 second

\$PASHS,ATM,ATR is used only to enable or disable the recording or output of ATOM ATR XDR messages. These are generated when a meteorological unit or tiltmeter is used.

When the ATOM RXN message is enabled, and regardless of the last \$PASHS,ATM,ATR command run, the following messages are always recorded in the G-file:

- ATOM ATR ANM (antenna name)
- ATOM ATR RNM (receiver name)
- ATOM ATR AOP (antenna offset parameter)
- ATOM ATR OCC (occupation)

ATOM PVT messages contain the following sub-blocks: COO, ERR, VEL, CLK, LCY, HPR, BLN, MIS, PRR and SVS.

DAT messages are generated every time a new frame is decoded.

Example

Enabling ATOM message type PVT on serial port A at a 1-second output rate:

```
$PASHS,ATM,PVT,A,ON,1*0E
```

Relevant Query \$PASHQ,ATO
Commands \$PASHQ,ATM

See also \$PASHS,ATM,PER
 \$PASHS,ATM,ALL

ATM,ALL: Disabling All ATOM Messages

Function This command disables all ATOM messages currently enabled on the specified port.

Command Format **Syntax**
 \$PASHS,ATM,ALL,c1,OFF[*cc]

Parameters

Parameter	Description	Range
c1	Port related to the ATOM message(s) you want to disable. <ul style="list-style-type: none"> A: Serial port C: Bluetooth port E: Modem M, U: Internal memory (M), USB key (U) 	A, C, E, M, U
*cc	Optional checksum	*00-*FF

Example

Disabling all ATOM messages on port A:

```
$PASHS,ATM,ALL,A,OFF*4E
```

Relevant Query Command None.

See also \$PASHS,ATM

ATM,PER: Setting Unique Output Rate for all ATOM Messages

Function This command is used to set the same output rate for all ATOM messages. This command will overwrite all the output rates set individually for each message type using \$PASHS,ATM,RNX and \$PASHS,ATM,PVT.

Command Format Syntax

```
$PASHS,ATM,PER,f[*cc]
```

Parameters

Parameter	Description	Range
f	Output rate. Setting \$PASHS,POP to "20" is a prior condition to operating at 0.05 s (20 Hz).	0.05 sec or 0.1-0.4 sec if the [F] option is activated 0.5-0.9 sec 1-999 sec
*cc	Optional checksum	*00-*FF

Example

Setting the output rate to 1 second:

```
$PASHS,ATM,PER,1*5B
```

Relevant Query Command \$PASHQ,ATM

See also \$PASHS,ATM

ATM,VER: Setting the Version of ATOM Messages

Function This command is used to set the version in which the receiver will generate ATOM messages on all its ports.

Command Format Syntax
 \$PASHS,ATM,VER,d[*cc]

Parameters

Parameter	Description	Range	Default
d	Index of ATOM version: <ul style="list-style-type: none"> • 1: ATOM V1 • 2: ATOM V2 	1, 2	2
*cc	Optional checksum	*00-*FF	-

Example

Setting to ATOM V2:

\$PASHS,ATM,VER,2*5E

Relevant Query Command \$PASHQ,PAR

See also \$PASHS,ATM

BAS: Differential Data Type

Function This command is used in a base to select the type of differential data the base should generate and the port, or two ports, through which this data should be routed. The command can also be used with the OFF operator to disable the output.

Command Format Syntax

\$PASHS,BAS,c1,s2[,c3,s4][*cc]

or, to disable the differential data output:

\$PASHS,BAS,OFF[*cc]

Parameters

Parameter	Description	Range
c1	First port ID: <ul style="list-style-type: none"> • A: Serial port (default) • C: Bluetooth port • E: Modem • M, U: Internal memory (M), USB key (U) 	A, C, E, M, U
s2	Differential data type: <ul style="list-style-type: none"> • RT2: RTCM 2.3 messages • RT3: RTCM 3.0 & 3.1 messages (default) • CMR: CMR messages • CMP: CMR+ messages • ATM: ATOM messages • DBN: DBEN messages 	RT2, RT3, CMR, CMP, ATM, DBN
c3	Second port ID: same as c1 above	A, C, E, M, U
s4	Differential data type: same as s2 above.	RT2, RT3, CMR, CMP, ATM, DBN
*cc	Optional checksum	*00-*FF

Examples

Sending RTCM 3.0 message to the external UHF transmitter via port A:

\$PASHS,BAS,A,RT3*51

Sending RTCM 2.3 messages to the external UHF transmitter via port D and CMR+ messages to the GSM modem via port E:

\$PASHS,BAS,D,RT2,E,CMP*4E

Disabling the differential data output:

\$PASHS,BAS,OFF*46

Relevant Query Command

\$PASHQ,BAS

See also

\$PASHS,CPD,MOD

\$PASHS,RTC,TYP

\$PASHS,RNX,TYP

\$PASHS,CMR,TYP

BEEP: Beeper Setup

Function This command enables or disables the internal beeper.

Command Format **Syntax**

`$PASHS,BEEP,s1[,d2][*cc]`

Parameters

Parameter	Description	Range	Default
s1	Enables (ON) or disables (OFF) the beeper.	ON, OFF	ON
d2	Timeout, in seconds: <ul style="list-style-type: none"> • 0: No timeout. If an alarm is activated, the beeper will sound indefinitely until the alarm is acknowledged. • >0: If an alarm is activated, the beeper will sound only for a limited period of time (it will go out automatically at the end of the specified timeout). 	0-99	30
*cc	Optional checksum	*00-*FF	

Example

Disabling the beeper:

`$PASHS,BEEP,OFF*04`

Relevant Query Command `$PASHQ,BEEP`

BRD: Enabling/Disabling the RTC Bridge Function

Function This command is used to control the RTC Bridge function. Its use is required only in the receiver in charge of forwarding its RTK corrections to other nearby rovers through its licence-free radio transmitter.

Command Format **Syntax**

`$PASHS,BRD,s1[,d2,c3,c4][*cc]`

Parameters

Parameter	Description	Range	Default
s1	Controls the availability of RTK corrections on the specified output port: <ul style="list-style-type: none"> • OFF: No RTK corrections forwarded to the output port. • ON: RTK corrections forwarded to the output port. 	ON, OFF	OFF
d2	Enables or disables the use of RTK corrections in the receiver's position computation. <ul style="list-style-type: none"> • 0: RTK corrections used • 1: RTK corrections not used 	0, 1	0
c3	Input port ID (port from which RTK corrections are available in the receiver).	E (modem)	E
c4	Output port ID (serial port to which the licence-free radio transmitter is connected).	A	A
*cc	Optional checksum	*00-FF	

Examples

Enabling RTC Bridge in the receiver by forwarding RTK corrections from the modem to its port A (to which the license-free radio transmitter is connected):

```
$PASHS,BRD,ON,0,E,A*14
```

Disabling RTC Bridge by preventing RTK corrections from being forwarded to the output port:

```
$PASHS,BRD,OFF*42
```

Comments

- To receive data, the \$PASHS,NTR,.. and \$PASHS,DIP commands should be used.
- If the data needs to be sent to an external UHF transmitter, the \$PASHS,RDP command should be used to configure the transmitter.
- The d2 parameter is taken into account only if the Automatic mode is selected for the choice of differential data inputs (see \$PASHS,CPD,REM).

Relevant Query Command

```
$PASHQ,BRD
```

See also

```
$PASHS,NTR,..
$PASHS,DIP
$PASHS,RDP,TYP
```

\$PASHS,RDP,PAR

\$PASHS,CPD,REM

Using RTC Bridge

The RTC Bridge function is typically used to allow a rover to forward the RTK corrections it receives from an RTK network through its built-in modem to other rovers operated in the vicinity, using a license-free radio transmitter connected to its serial port. Being a low-power unit (<500 mW), the license-free radio can be powered directly from the receiver, without the need for another external battery.

Starting RTC Bridge is a three-step procedure:

- Mounting the license-free radio onto the range pole and connecting it to port A using the Y-shaped cable supplied (USB connection is for powering the radio, the other connection to the serial port is for the data).
- Setting the license-free radio, then the GPRS modem, using FAST Survey.
- Activating RTC Bridge through a serial command (\$PASHS,BRD) sent from FAST Survey.

This procedure is detailed below.



Mounting and Connecting the License-Free Radio

The following setup is recommended for both the “transmitting” rover and the “receiving” rover(s).



Setting the License-Free Radio

Follow the instructions below. Each step should be executed in the specified order:

1. Establish a connection with the receiver from FAST Survey
2. Select **Equip>GPS Rover** and then tap on the **RTK** tab
3. In the **Device** field, select “ARF7474..” corresponding to the license-free radio used.
4. Tap on  and complete the license-free radio settings.
5. Still on the **RTK** tab and in the same **Device** field, select “Internal GSM”.
6. Tap on  and and complete the GSM settings.
7. Tap  to complete the receiver setting.

Activating RTC Bridge

- In FAST Survey, select **Equip>GPS Utilities** and then tap on the **Send Command** button.
- In the combo box, type the following command, assuming port E is the input port and port A the output port:
`$PASHS,BRD,ON,0,E,A`
- Tap on the **Send** button. The RTC Bridge function is activated once the receiver has executed the command and the `$PASHR,ACK*3D` line has been returned to FAST Survey.

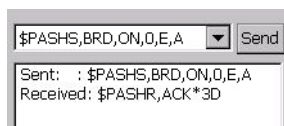

- Tap  twice to close the **GPS Utilities** window and return to the FAST Survey menu.

NOTE: As for the configuration of the rovers supposed to receive the RTK corrections from this receiver, there is nothing else to be done apart from configuring the licence-free radio connected to each of them. Setting this radio can be done using FAST Survey, from the **RTK** tab of the **GPS Rover** window (select the appropriate radio model in the **Device** field).

BTH,NAME: Bluetooth Device Name

Function This command is used to name the Bluetooth device.

Command Format **Syntax**

\$PASHS,BTH,NAME,s1[*cc]

Parameters

Parameter	Description	Range
s1	Bluetooth device name	64 characters max.
*cc	Optional checksum	*00-*FF

Example

Naming the Bluetooth device as “My Surveying Unit”:

\$PASHS,BTH,NAME,My Surveying Unit*60

Relevant Query Command \$PASHQ,BTH

See also \$PASHS,BTH,PIN

BTH,PIN: Bluetooth Device Pin Code

Function This command is used to assign a PIN code to the Bluetooth device.

Command Format **Syntax**

\$PASHS,BTH,PIN,d1[*cc]

Parameters

Parameter	Description	Range
d1	Bluetooth PIN code	16 digits max. -1: no PIN code
*cc	Optional checksum	*00-*FF

Example

Assigning PIN code “02” to the Bluetooth device:

\$PASHS,BTH,PIN,02*7E

Relevant Query Command \$PASHQ,BTH

See also \$PASHS,BTH,NAME

CFG: GNSS Tracking Configuration

Function This command is used to set the GNSS tracking configuration in the receiver.

Command Format Syntax

\$PASHS,CFG,s1[*cc]

Parameters

Parameter	Description	Range
s1	GNSS tracking configuration: <ul style="list-style-type: none"> • SSL: Single-signal tracking • DSL: Dual-signal tracking • TSL: Triple-signal tracking 	SSL, DSL, TSL
*cc	Optional checksum	*00-*FF

The possible GNSS tracking configurations are detailed in the table below.

	Single Signal	Dual Signal	Triple Signal
GPS Tracking	14 GPS (similar to \$PASHS,GNS,CFG, 0 or 1)	See \$PASHS,GPS command	See \$PASHS,GPS command
GLONASS Tracking	14 GLO (L1 only)	14 GLO (L1+L2)	10 GLO (L1+L2)
GALILEO Tracking	8 GAL E1 only	8 GAL (E1+E5a)	8 GAL (E1+E5a)
SBAS Tracking	2 + SBAS	2 SBAS	2 SBAS

Default Settings

They depend on the presence or not of two firmware options ([P] option for L2, [Q] option for L5). See tables below (the \$PASHS commands detailed in some of the cells below

describe the resulting default settings, as if you had run these commands at start-up).

Common Defaults	[Q] Option Enabled	No [Q] Option
[P] Option Enabled	Default is DSL; GPS,ON,1C,2LW	
No [P] Option	Default is DSL; \$PASHS,GPS,ON,1C,5Q	Default is SSL; \$PASHS,CFG,DSL is NAKed

TSL Defaults	[Q] Option Enabled	No [Q] Option
[P] Option Enabled	\$PASHS,GPS,ON,1C,2LW,L5	\$PASHS,GPS,ON,1C,2W,2L
No [P] Option	\$PASHS,CFG,TSL is NAKed	\$PASHS,CFG,TSL is NAKed

Comments

- Changing the GNSS tracking configuration will automatically cause the receiver to re-start.
- The settings you make by running \$PASHS,CFG have priority over those you make using \$PASHS,GPS (for GPS), \$PASHS,GLO (for GLONASS) and \$PASHS,GAL (for Galileo). After you have run \$PASHS,CFG to change the GNSS tracking configuration, GNSS tracking is set to the appropriate defaults, depending on the installed firmware options.
- Using \$PASHS,CFG to change the GNSS tracking mode does not affect the output of periodical messages as long as they are compatible with the selected mode. For example, if “SSL” is selected and a message is then programmed through \$PASHS,NME,POS,A,ON, then changing the GNSS tracking mode to “DSL” will not affect the message at all.
- The L2C signal has priority over the L2P signal if both signals are available for a given satellite (2LW mode)
- Whenever \$PASHS,CFG is run, appropriate defaults are restored.

Example

Setting the receiver in dual-signal configuration:

```
$PASHS,CFG,DSL*40
```

Relevant Query Command \$PASHQ,CFG
 \$PASHQ,PAR

See also \$PASHS,GPS

\$PASHS,GLO
 \$PASHS,SBA
 \$PASHS,GAL

CMD,LOD: Running a List of \$PASH Commands

Function This command is used to run the complete list of \$PASH commands stored in a file found in the USB key currently connected to the receiver.
 This implies that the file (in text editable format) should have first been saved to that key before connecting the key to the receiver's USB port.

Command Format **Syntax**

`$PASHS,CMD,LOD[,s][*cc]`

Parameters

Parameter	Description	Range	Default
s	File name. If s is omitted, it is assumed that the file to be run is "autoconfig.cmd".	255 characters max.	autoconfig.cmd
*cc	Optional checksum	*00-*FF	

Examples

Running the serial commands in autoconfig.cmd:

`$PASHS,CMD,LOD*54`

Running the serial commands in a file named "myconfig.cmd":

`$PASHS,CMD,LOD,myconfig.cmd*02`

Comments

- The file can contain any \$PASHS or \$PAHSQ commands.
- If the file contains the \$PASHS,REC or \$PASHS,INI command, this command will always be run last, whatever its position in the file.
- All data lines returned by the receiver in response to the executed commands are written to a log file named as follows:

<command_file_name>.log

- To insert an idle wait time of several seconds between any two \$PASH commands, you can insert a specific command named \$PASHS,CMD,WTI between these two commands. The \$PASHS,CMD,WTI command may be inserted as many times as necessary in the file.
- Naming the command file “autoconfig.cmd” or “uploadconfig.cmd” on the USB key will allow the receiver to automatically start the execution of all the commands stored in the file when you plug the USB key to the receiver. 6A6EC3667E000The difference between the two file names is in the need for a user confirmation before running the file: “autoconfig.cmd” will require user confirmation, not “uploadconfig.cmd”.

Relevant Query Command None.

See also \$PASHS,CMD,WTI

CMD,WTI: Inserting Wait Times

Function This command can be inserted one or more times in the list of \$PASH commands run with the CMD,LOD command. When running this command, in fact the receiver inserts a wait time of the requested value in the execution of the \$PASH commands.

Command Format Syntax

\$PASHS,CMD,WTI,d[*cc]

Parameters

Parameter	Description	Range
d	Wait time generated by the command, in seconds.	1-3600
*cc	Optional checksum	*00-*FF

Example

The command line below inserted in a command file will generate a 10-s wait time when executed:

\$PASHS,CMD,WTI,10*74

Comments This command will be interpreted by the receiver only if found in a command file.

Relevant Query Command None.

See also \$PASHS,CMD,LOD

CMR,TYP: CMR Message Type and Rate

Function This command is used in a base to set the type and rate of CMR message the base will generate and output.

Command Format Syntax

\$PASHS,CMR,TYP,d1,d2[*cc]

Parameters

Parameter	Description	Range
d1	Message type	0, 1, 2, 3 (See table below)
d2	Output rate in seconds	0, 0.5 or 1-300 (See table below)
*cc	Optional checksum	*00-*FF

Message Type	Description	Output Rate (Range)	Output Rate (Default)
0	Observables	0, 0.5 s or 1-300 s	1 s
1	Base coordinates	0-300 s	30 s
2	Base description	0-300 s	30 s
3	GLONASS observables	0, 0.5 s or 1-300 s	1 s

Examples

Setting a CMR message type 0 (observables) at a 1-second output rate:

\$PASHS,CMR,TYP,0,1*59

Setting a CMR message type 1 (base coordinates) at a 30-second output rate:

\$PASHS,CMR,TYP,1,30*6A

Relevant Query Command \$PASHQ,CMR,MSI

See also \$PASHS,BAS
\$PASHS,CPD,MOD,BAS

CPD,AFP: Setting the Confidence Level of Ambiguity Fixing

Function This command is used to set the confidence level required of the ambiguity fixing process. The higher the confidence level, the more likely the ambiguities are fixed correctly, but the longer the time it takes to fix them.

Command Format Syntax

\$PASHS,CPD,AFP,f1[*cc]

Parameters

Parameter	Description	Range	Default
f1	Confidence level, in percent, required of ambiguity fixing process. Choosing "0" means the receiver will not try to fix ambiguities but instead will stay indefinitely in Float mode.	0, 95.0, 99.0 or 99.9	99.0
*cc	Optional checksum	*00-*FF	-

Example

Setting the confidence level to 99.9%:

\$PASHS,CPD,AFP,99.9*62

Relevant Query Commands \$PASHQ,CPD,AFP
\$PASHQ,CPD

CPD,FST: RTK Output Mode

Function This command enables or disables the fast RTK output mode (Fast CPD mode).

Command Format Syntax
\$PASHS,CPD,FST,s1[*cc]

Parameters

Parameter	Description	Range	Default
s1	Enables (ON) or disables (OFF) the fast RTK output mode	ON, OFF	ON
*cc	Optional checksum	*00-*FF	-

Example

Enabling the fast RTK output mode:

\$PASHS,CPD,FST,ON

Relevant Query Command \$PASHQ,CPD,FST

CPD,MOD: Base/Rover/Backup Mode

Function This command is used to set the addressed receiver as a base or a rover, thus defining the operating mode for the receiver. In addition the command allows you to specify the satellite constellations that will be used if the receiver is defined as a base. Additionally, this command allows a rover to be set to deliver two independent RTK position solutions. This can be done by activating the backup mode.

Command Format Syntax
\$PASHS,CPD,MOD,s1[, [d2],[d3],[c4]][*cc]

Parameters

Parameter	Description	Range	Default
s1	CPD mode: <ul style="list-style-type: none"> • BAS: Base • ROV: Rover • BKP: Backup ("Hot Standby RTK") 	BAS, ROV, BKP	ROV
d2	Constellations used in the base: <ul style="list-style-type: none"> • 0: GPS, GLONASS, SBAS (default) • 1: Only GPS and SBAS • 2: Only GPS and GLONASS • 3: Only GPS 	0-3	0
d3	Position mode. If s1=BAS: <ul style="list-style-type: none"> • 0: Base position is a static position (as set through \$PASHS,POS). • 1: Base position is a moving position • 2: "Current position" (the command allocates the currently computed position to the base. The base position is then kept unchanged.) If s1=ROV: <ul style="list-style-type: none"> • 0: Rover operates with static base • 1: Rover operates with moving base 	0-2	0
c4	Input port for backup mode: <ul style="list-style-type: none"> • A: Serial port • C: Bluetooth port • D: Radio • E: Modem 	A, C, D, E	A
*cc	Optional checksum	*00-*FF	

Examples

Setting the receiver as a base using all constellations:

```
$PASHS,CPD,MOD,BAS,0*28
```

Setting the receiver as a rover:

```
$PASHS,CPD,MOD,ROV*2F
```

Setting the receiver to operate as a rover in which the backup mode is activated and port A is used for that purpose:

```
$PASHS,CPD,MOD,BKP,,,A*50
```

Comments

- With s1=BAS (Base mode) and d3=2 ("Current position"), once the current position has been defined as the base position, then the position mode is automatically switched to "0". The base position can then be read using the \$PASHQ,CPD,POS command.

- In “Hot Standby RTK” (s1=BKP), the receiver computes two independent positions from the two independent corrections streams entering the receiver. The input port for the correction stream of the primary RTK is defined by the \$PASHS,CPD, REM command. The input port for the correction stream of the backup RTK position is defined by parameter c4 in \$PASHS,CPD,MOD. The receiver checks that the submitted value for c4 is compatible with the settings last performed with \$PASHS,CPD,REM. In “Hot Standby RTK”, the position delivered by the receiver through the chosen output messages (ATM, PVT, GGA, etc.) is the best position between the primary RTK and backup RTK. The receiver itself determines which is the best position, based on all the available parameters and indicators. At any time, users can find out which RTK provides the best position by analyzing the Base Station ID field in these messages.
- The backup position is computed only from reference data received at integer seconds of time intervals.
- In “Hot Standby RTK”, the Fast CPD mode is always active (ON) whatever the setting last performed with \$PASHS,CPD, FST. In addition, the base is assumed to be static regardless of the current value assigned to parameter d3 in \$PASHS,CPD,MOD.

Relevant Query Command \$PASHQ,CPD,MOD

See also \$PASHS,BAS
 \$PASHS,CPD,REM
 \$PASHS,CPD,FST

CPD,NET: Network Corrections

Function This command sets the behavior of the receiver with relation to network corrections, i.e. RTK correction data delivered by a network.

Command Format Syntax
 \$PASHS,CPD,NET,d1[,d2][*cc]

Parameters

Parameter	Description	Range	Default
d1	RTK network operating mode relative to GPS corrections: <ul style="list-style-type: none"> • 0: GPS corrections from network are not used. • 1: FKP/MAC GPS corrections from network are used when available and healthy, otherwise they are rejected. 	0-1	1
d2	RTK network operating mode relative to GLONASS corrections: <ul style="list-style-type: none"> • 0: GLONASS corrections from network are not used. • 1: FKP/MAC GLONASS corrections from network are used when available and healthy, otherwise they are rejected. 	0-1	0
*cc	Optional checksum	*00-FF	

Example

Setting the receiver to process GPS and GLONASS network corrections:

```
$PASHS,CPD,NET,1,1*51
```

Relevant Query Command

```
$PASHQ,CPD,NET
```

CPD,REM: Differential Data Port

Function

This command sets the reception mode for all differential data.

If Automatic is chosen, all received differential data is processed whatever the input ports.

On the contrary, if Manual is chosen, only the data coming in through the specified ports (one or two ports) will be processed.

Command Format

Syntax

```
$PASHS,CPD,REM,s1[,c2][,c3][*cc]
```

Parameters

Parameter	Description	Range	Default
s1	Reception mode: <ul style="list-style-type: none"> • AUT: Automatic (default) • MAN: Manual 	AUT, MAN	AUT
c2	Input port #1: <ul style="list-style-type: none"> • A: Serial port • C: Bluetooth port • D: Radio • E: Modem 	A, C, D, E	
c3	Input port #2: <ul style="list-style-type: none"> • A: Serial port • C: Bluetooth port • D: Radio • E: Modem 	A, C, D, E	
*cc	Optional checksum	*00-*FF	

Examples

Setting the receiver to receive and process differential data in Automatic mode:

```
$PASHS,CPD,REM,AUT*38
```

Setting the receiver to receive and process differential data in Manual mode with the data received on port D:

```
$PASHS,CPD,REM,MAN,D*52
```

Relevant Query Command \$PASHQ,CPD,REM

See also \$PASHS,CPD,MOD

CPD,RST: RTK Process Reset

Function This command resets the RTK processing.

Command Format Syntax

```
$PASHS,CPD,RST[*cc]
```

Parameters

None.

Example

Resetting the RTK processing:

\$PASHS,CPD,RST*5B

Relevant Query Command None.

CPD,VRS: VRS Assumption Mode

Function This command is used specifically to set the receiver (a rover) to operate in the so-called “compulsory VRS mode” through which it is forced to consider that the differential corrections it receives are always VRS corrections (this impacts the way corrections are processed internally).

When not operated in this mode, the receiver will automatically detect whether the received corrections are, or are not, VRS corrections (Automatic detection).

Command Format Syntax

\$PASHS,CPD,VRS,d[*cc]

Parameters

Parameter	Description	Range	Default
d	VRS assumption mode: <ul style="list-style-type: none"> • 0: Automatic detection • 1: Compulsory VRS mode • 2: Never switches to VRS mode 	0, 1, 2	0
*cc	Optional checksum	*00-*FF	

Example

Enabling the compulsory VRS mode:

\$PASHS,CPD,VRS,1*44

Comment Users working in VRS using the CMR or RT2 format should activate the compulsory VRS mode (d=1).

Relevant Query Command \$PASHQ,CPD,VRS

CTS: Handshaking

Function This command enables or disables the RTS/CTS handshaking protocol for the specified port. If no port is specified, the command applies to the port through which the command is routed.

Command Format Syntax
\$PASHS,CTS,[c1],s2[*cc]

Parameters

Parameter	Description	Range	Default
c1	Port ID	A	
s2	RTS/CTS control (default: ON)	ON, OFF	ON
*cc	Optional checksum	*00-*FF	

Example

Disabling RTS/CTS on port A:

\$PASHS,CTS,A,OFF*3F

Relevant Query Command \$PASHQ,CTS

See also \$PASHS,PRT
 \$PASHS,MDP

DBN,TYP: DBEN Message Type & Output Rate

Function This command is used in a base to define the type of DBEN message the base should generate (type and rate). Enabling or disabling the output of the DBEN message is made through \$PASHS,BAS or \$PASHS,BDS.

Command Format Syntax
\$PASHS,DBN,TYP,s1,d2[*cc]

Parameters

Parameter	Description	Range
s1	Message type	See table below
d2	Output rate, in seconds	See table below
*cc	Optional checksum	*00-*FF

Type	Description	Range	Default Output Rate
RPC	Code & phase measurement	0, 0.1-0.9 s and 1-300 s	1
BPS	Reference station position	0-300 s	30

Examples

Selecting DBEN message type “RPC” at 0.5 second:

\$PASHS,DBN,TYP,RPC,0.5*26

Selecting DBEN message type “BPS” at 60 seconds:

\$PASHS,DBN,TYP,BPS,60*0B

Relevant Query Command

\$PASHQ,DBN,MSI

See Also

\$PASHS,BAS

\$PASHS,BDS

DIP: Server Connection

Function

This command is used to connect the receiver to a base via the base's IP address or host name.

Command Format

Syntax

\$PASHS,DIP,RIP,s1,PRT,d2[,LGN,s3,PWD,s4][*cc]

Parameters

Parameter	Description	Range
RIP,s1	IP address (xxx.xxx.xxx.xxx) or host name	32 char. max.
PRT,d2	Port number	0-65535
LGN,s3	User name (optional)	32 char. max.
PWD,s4	Password (optional)	32 char. max.
*cc	Optional checksum	*00-*FF

Comments

Optional fields s3 and s4 need to be specified when the base used requires a user name and password. In this case, the receiver sends the \$GUUID,s2,s4 command to the base right after the IP connection has been established.

Examples

Connecting the receiver to IP address 134.20.2.100 and port number 6666:

```
$PASHS,DIP,RIP,134.20.2.100,PRT,6666*2C
```

Connecting the receiver to www.MyProFlex.com through port 2100:

```
$PASHS,DIP,RIP,www.MyProFlex.com,PRT,2100*6E
```

Relevant Query Commands \$PASHQ,MDM
\$PASHQ,DIP

See also \$PASHS,MDM,...
\$PASHS,DIP,ON
\$PASHS,DIP,OFF

DIP,OFF: Terminating Direct IP Connection

Function This command is used to terminate the current IP connection to a server.

Command Format Syntax
\$PASHS,DIP,OFF[,c1][*cc]

Parameters

None.

Examples

Terminating the current connection:

\$PASHS,DIP,OFF*4B

Relevant Query Command \$PASHQ,MDM

See also \$PASHS,DIP
 \$PASHS,DIP,PAR
 \$PASHS,DIP,ON

DIP,ON: Establishing the Programmed Direct IP Connection

Function This command is used to establish the programmed Direct IP connection.

Command Format Syntax
\$PASHS,DIP,ON[,c1][*cc]

Parameters

None.

Examples

Establishing the programmed Direct IP connection:

\$PASHS,DIP,ON*05

Relevant Query Command \$PASHQ,MDM

See also \$PASHS,DIP
 \$PASHS,DIP,PAR
 \$PASHS,DIP,OFF

DIP,PAR: Setting Direct IP Parameters

Function This command is used to set the different parameters allowing the receiver to perform a Direct IP connection to an external server, typically a base.

Command Format Syntax

`$PASHS,DIP,PAR,ADD,s1,PRT,d2[,LGN,s3,PWD,s4][*cc]`

Parameters

Parameter	Description	Range	Default
ADD,s1	IP address or host name of external server	32 characters max.	
PRT,d2	IP port of external server	0-65535	
LGN,s3	User name (optional)	32 characters max.	
PWD,s4	Password (optional)	32 characters max.	
*cc	Optional checksum	*00-*FF	

Comments

When connecting to the specified server requires a user name and password, then the receiver will send the serial command `$GPRID,s3,s4` after the IP connection with the server has been established.

Examples

Entering the parameters of the server the receiver has to connect to (through an IP address):

`$PASHS,DIP,PAR,ADD,192.65.54.1,PRT,2100*74`

Entering the parameters of the server the receiver has to connect to (through a host name):

`$PASHS,DIP,PAR,ADD,www.MyProFlex.com,PRT,2100*0B`

Relevant Query Commands `$PASHQ,DIP`
`$PASHQ,MDM`

See Also `$PASHS,DIP,ON`
`$PASHS,DIP,OFF`
`$PASHS,MDM`

DRI: Raw Data Recording Rate

Function This command sets the recording rate for all raw data logged in the internal or external memory. This rate can be independent of the data output rate on a serial port.

Command Format Syntax

\$PASHS,DRI,[*cc]

Parameters

Parameter	Description	Range	Default
s	Raw data recording rate. Setting \$PASHS,POP to "20" is a prior condition to operating at 0.05 s (20 Hz).	0.05 sec or 0.1-0.4 sec if the [F] option is activated. 0.5-0.9 s 1-999 s	1 s
*cc	Optional checksum	*00-*FF	

Example

Setting the recording rate to 5 seconds:

\$PASHS,DRI,5*33

Relevant Query Command

\$PASHQ,DRI

See also

\$PASHS,ATM

\$PASHS,RAW

\$PASHS,REC

\$PASHS,POP

DSY: Daisy Chain

Function

This command is used to redirect all the characters flowing through a given serial port (source port) to another (destination port), without interpreting the flow of redirected data.

Once the daisy chain mode is on, only the command used to discontinue this mode can be interpreted on the source port. Redirection can be in both directions, in which case two DSY commands, instead of one, are required to allow bidirectional data flow.

Command Format Syntax

Redirecting data from a source port to a destination port:

\$PASHS,DSY,c1,c2[,d3][*cc]

Discontinuing the daisy chain mode from a specified source port:

```
$PASHS,DSY,c1,OFF[*cc]
```

Discontinuing the daisy chain mode for all source ports:

```
$PASHS,DSY,OFF[*cc]
```

Parameters

Parameter	Description	Range
c1	Source port ID	A, C, D, E
c2	Destination port ID	A, C, D, E
d3	Mode: <ul style="list-style-type: none"> • 0: Raw (default). Data are sent to the destination port as and when they arrive. • 1: Block. Data are sent to the destination port only after a complete message has arrived. 	0,1
*cc	Optional checksum	*00-*FF

Examples

Redirecting port D to port A:

```
$PASHS,DSY,D,A*3E
```

Redirecting port D to port A and port A to port D:

```
$PASHS,DSY,D,A*3E
$PASHS,DSY,A,D*3E
```

Discontinuing the daisy chain mode from port A:

```
$PASHS,DSY,A,OFF*35
```

Discontinuing the daisy chain mode from all source ports:

```
$PASHS,DSY,OFF*58
```

DYN: Receiver Dynamics

Function This command allows you to define the receiver dynamics. The chosen number best represents the receiver motion.

Command Format **Syntax**

```
$PASHS,DYN,d1[*cc]
```

Parameters

Parameter	Description	Range	Default
d1	Receiver dynamics: <ul style="list-style-type: none"> • 1: Static • 2: Quasi-static • 3: Walking • 4: Ship • 5: Automobile • 6: Aircraft • 7: Unlimited • 8: Adaptive • 9: User-defined 	1-9	8
*cc	Optional checksum	*00-*FF	

Example

Setting rover dynamics to “Walking”:

```
$PASHS,DYN,3*39
```

Comments

In the adaptive mode (8), the receiver analyzes its own motion and automatically chooses one of the dynamic models that is the most suitable. The possible dynamic models are those corresponding to the other choices in the command (i.e. 2 to 7, but not 1 or 9). Using the adaptive mode rejects the possible use of the user-defined dynamic model.

Relevant Query Command \$PASHQ,DYN

See Also \$PASHS,UDP

ELM: Setting the Elevation Mask for Raw Data Output

Function This command is used to set the minimum satellite elevation for raw data recording, raw data and differential data output.

Command Format **Syntax**
 \$PASHS,ELM,d1[*cc]

Parameters

Parameter	Description	Range	Default
d1	Elevation mask, in degrees.	0-90°	5
*cc	Optional checksum	*00-*FF	

Example

Setting the elevation mask to 10 degrees:

```
$PASHS,ELM,10*1C
```

FIL,D: Deleting Files

Function This command allows you to delete files from the selected internal or external memory.

Command Format Syntax

```
$PASHS,FIL,D,d[*cc]
```

Parameters

Parameter	Description	Range
d	File index number: <ul style="list-style-type: none"> In the range 0-99: With file index number=n, then file "n+1" will be deleted. Warning! If the deleted file is not the last one in memory, all the files that follow the deleted file will have their index number re-ordered after deletion of the file. The index of a file is as listed when using the \$PASHQ,FLS command. =999: All the files in memory will be deleted, except for the following: G-file in use, D-file in use, ring file buffer, ATL file in use, all directories, all .log files excluding ATL log files not in use. 	0-99, 999
*cc	Optional checksum	*00-*FF

Example

Deleting the 6th file from memory:

```
$PASHS,FIL,D,5*47
```

Comments

If the file you want to delete is the only file present in the selected memory and this file is currently being used, the “NAK” message is returned to inform you that the file cannot be deleted.

Relevant Query Command

None.

See also

\$PASHQ,FLS
\$PASHS,MEM to select the memory from which to delete files.

FIL,DEL: Deleting Files and Directories

Function

This command allows you to delete files and directories from the selected internal or external memory.

Command Format**Syntax**

```
$PASHS,FIL,DEL,[d1],[s2],s3[s4[...sn]][*cc]
```

Parameters

Parameter	Description	Range
d1	Memory from which to delete files or directories: • 0: Internal memory. • 2: USB key. If d1 is omitted, files or directories are deleted from the memory specified by the last run \$PASHS,MEM command.	0, 2
s2	Path	255 characters max.
s3	Name of the file or directory you want to delete.	255 characters max.
	...	
sn	Name of the file or directory you want to delete.	255 characters max.
*cc	Optional checksum	*00-*FF

Comments

- To delete a file or directory located in a subdirectory, the full path to this file or directory should be specified in the s2 field. You cannot enter a path in the s3 field.

- The “*” character can be used as a wild card to delete several files at the same time. In this case, the complete string should be placed between simple or double quotation marks.

Examples

Deleting a G file:

```
$PASHS,FIL,DEL,,,GabcdA09.241*69
```

Deleting three G files:

```
$PASHS,FIL,DEL,,,GabcdA09.241,GabcdB09.242,GabcdC09.242*68
```

Deleting a G file from a subdirectory located on the USB key:

```
$PASHS,FIL,DEL,2,2009/241/,GabcdA09.241*67
```

Deleting all the files from the USB key:

```
$PASHS,FIL,DEL,2,,".*"*67
```

Deleting all the files recorded on the USB key on the 241th day of the year:

```
$PASHS,FIL,DEL,2,,"*.241"*7A
```

Relevant Query Command

None.

See also

```
$PASHQ,FIL,LST
$PASHS,MEM
```

GAL: Galileo Tracking

Function

This command is used to enable or disable Galileo tracking. Enabling Galileo tracking will power on the corresponding part in the RF section and the FPGA (Field-Programmable Gate Array), if not powered on yet.

Conversely, disabling Galileo tracking will power off the corresponding part in the RF section, and the FPGA, unless GPS reception requires that they both be kept in use.

Command Format

Syntax

```
$PASHS,GAL,s1[*cc]
```

Parameters

Parameter	Description	Range	Default
s1	Enabling/disabling Galileo tracking: <ul style="list-style-type: none"> • On: Track and use Galileo satellites • Off: Do not track Galileo satellites 	ON, OFF	OFF
*cc	Optional checksum	*00-*FF	-

Comments

The command is NAKed if the [O] option is not installed or the receiver does not support Galileo.

Example

Enabling Galileo:

```
$PASHS,GAL,ON*12
```

Relevant Query Command \$PASHQ,GAL
 \$PASHQ,PAR

See also \$PASHS,CFG
 \$PASHS,SBA
 \$PASHS,GPS
 \$PASHS,GLO

GLO: GLONASS Tracking

Function This command is used to enable or disable GLONASS tracking. It is valid only if the GLONASS option has been activated in the receiver.

Command Format Syntax
 \$PASHS,GLO,s1[*cc]

Parameters

Parameter	Description	Range	Default
s1	Enables (ON) or disables (OFF) GLONASS tracking.	ON, OFF	ON
*cc	Optional checksum	*00-*FF	

Example

Enabling GLONASS:

```
$PASHS,GLO,ON*1C
```

Relevant Query Command \$PASHQ,GLO

See also \$PASHS,SBA

GPS: GPS Tracking

Function This command is used to enable or disable GPS tracking. Enabling GPS tracking will power on the corresponding part in the RF section, if not powered on yet.

Conversely, disabling GPS tracking will power off the corresponding part in the RF section, unless Galileo and SBAS reception requires that this part be kept in use.

Important! Combined with \$PASHS,CFG, this command makes command \$PASHS,GNS,CFG obsolete.

Command Format **Syntax**

```
$PASHS,GPS,ON[,s1[,s2[,s3]]][*cc]
```

```
$PASHS,GPS,OFF[*52]
```

Parameters

Parameter	Description	Range
s1	First Signal: • 1C: Tracking GPS L1 C/A signal	1C
s2	Second Signal: • 2L: Tracking L2CS signal for all GPS SVs • 2W: Tracking L2P signal for all GPS SVs • 2LW: Tracking L2CS signal for L2CS-capable GPS SVs and L2P for others • 5Q: Tracking L5 signal for all GPS SVs • "Blank": No second signal to be tracked	2L, 2W, 2LW, 5Q or "blank"
s3	Third Signal: • 2L: Tracking L2CS signal for all GPS SVs • 5Q: Tracking L5 signal for all GPS SVs • "Blank": No third signal to be tracked	2L, 5Q or "blank"
*cc	Optional checksum	*00-*FF

Remember the settings you make with \$PASHS,CFG have priority over those made with \$PASHS,GPS.

The table below summarizes the interaction between these two commands. Its content should be interpreted as follows:

- If you run one of the \$PASHS,GPS,... commands mentioned in the left-hand column,
- and you earlier chose to enable the single, dual- or triple-signal tracking using \$PASHS,CFG (headers of 2nd, 3rd, 4th columns),
- then the resulting tracking will be the one specified in the corresponding cell."NAK" means the command will be rejected (NAKed)

If You Run \$PASHS,GPS,... :	Single Signal	Dual Signal	Triple Signal
ON	14 GPS (Similar to \$PASHS,GNS,CFG, 0 or 1)	See \$PASHS,GPS command, Common Defaults table.	See \$PASHS,GPS command, TSL Defaults table.
ON,1C	14 GPS (similar to \$PASHS,GNS,CFG, 0 or 1)	Same as Single Signal; Second Signal not tracked.	Same as Single Signal; Second and Third Signals not tracked.
ON,1C,2W	NAK	12 GPS (C/A+P) (Similar to \$PASHS,GNS,CFG, 2 or 4)	Same as Dual Signal; Third Signal not tracked).
ON,1C,2L	NAK	12 GPS (C/A+L2CS) (Similar to \$PASHS,GNS,CFG, 3 or 5)	Same as Dual Signal; Third Signal not tracked).
ON,1C,2LW	NAK	12 GPS (C/A+(P or L2CS))	Same as Dual Signal; Third Signal not tracked).
ON,1C,5Q	NAK	12 GPS (C/A+L5)	Same as Dual Signal; Third Signal not tracked).

If You Run \$PASHS,GPS,.. ::	Single Signal	Dual Signal	Triple Signal
ON,1C,2W,2L	NAK	NAK	12 GPS (C/A+P+L2CS)
ON1C,2W,5Q	NAK	NAK	12 GPS (C/A+P+L5)
ON, 1C,2L,5Q	NAK	NAK	12 GPS (C/A+L2CS+L5)
ON,1C,5Q,2L	NAK	NAK	12 GPS (C/A+L5+L2CS)
ON,1C,2LW,5Q	NAK	NAK	12 GPS (C/A+(P or L2CS)+L5)

Example

Enabling GPS reception:

\$PASHS,GPS,ON,1C,2W*0B

Relevant Query Command \$PASHQ,GPS
 \$PASHQ,PAR

See also \$PASHS,CFG
 \$PASHS,SBA
 \$PASHS,GLO
 \$PASHS,GAL

INI: Receiver Initialization

Function This command resets the receiver memory and then restarts the receiver.

Command Format **Syntax**
 \$PASHS,INI,d1[*cc]

Parameters

Parameter	Description	Range
d1	Init code: <ul style="list-style-type: none"> • 0: Restarts the receiver without memory reset. • 1: Resets user settings, clears ephemeris, almanac and latest position/time data, and re-starts the receiver. • 2: Resets user settings, formats internal memory and re-starts the receiver. • 3: Resets user settings, formats internal memory, clears ephemeris, almanac and latest position/time data, and restarts the receiver. 	0, 1, 2, 3
*cc	Optional checksum	*00-*FF

Example

Resetting all and restarting the receiver:

```
$PASHS,INI,1*26
```

Relevant Query Command None.

See also \$PASHS,RST

LCS: Enabling/Disabling Use of Local Coordinate System

Function This command is used to enable or disable the use of the local coordinate system in the receiver. Having the receiver using a local coordinate system requires that it receives RTCM 3.1 message type 1021, 1022 or 1023 from the base.

Command Format Syntax
 \$PASHS,LCS,s1[*cc]

Parameters

Parameter	Description	Range	Default
s1	ON: Local coordinate system used if RTCM 3.1 messages received. OFF: Coordinate system used is WGS84.	ON, OFF	OFF
*cc	Optional checksum	*00-*FF	-

Example

Enabling the use of the local coordinate system in the receiver:

```
$PASHS,LCS,ON*04
```

Relevant Query \$PASHQ,LCS
Commands \$PASHQ,PAR

LOG,DEL: Deleting Log Files

Function This command is used to delete log files.

Command Format **Syntax**

```
$PASHS,LOG,DEL,d[*cc]
```

Parameters

Parameter	Description	Range
d	Index of the log file you want to delete. Use the \$PASHQ,LOG, LST command to read the index associated with each existing log file. Use d=999 to delete all the log files, but the current one.	0 to no limit
*cc	Optional checksum	*00-*FF

Example

Deleting all log files:

```
$PASHS,LOG,DEL,999*45
```

Relevant Query \$PASHQ,LOG,LST
Command

See Also \$PASHQ,LOG

LOG,PAR: Log File Settings

Function This command is used to set the log file. A log file keeps track of the different connections performed in a day (one file created per day).

Command Format Syntax

```
$PASHS,LOG,PAR,s1,d2,d3[*cc]
```

Parameters

Parameter	Description	Range	Default
s1	Enabling/disabling the log file: • ON: Enable • OFF: Disable	ON, OFF	ON
d2	Maximum size, in Mbytes, allowed for a log file.	1-90	1
d3	Number of days during which log files are kept in memory. After this delay, they are automatically deleted.	1-100	10
*cc	Optional checksum	*00-*FF	

Example

Enabling the log file with a maximum size of 2 Mbytes and 10 days of backup:

```
$PASHS,LOG,PAR,ON,2,10*40
```

Relevant Query Command \$PASHQ,LOG

See Also \$PASHS,LOG,DEL
\$PASHS,LOG,LST

LTZ: Time Zone

Function This command is used to set the local time zone.

Command Format Syntax`$PASHS,LTZ,d1,d2[*cc]`**Parameters**

Parameter	Description	Range	Default
d1	Local time zone (hours).	-13 to +13	0
d2	Local time zone (minutes)	0-59	0
*cc	Optional checksum	*00-*FF	

Example

Setting local time to UTC+2:

`$PASHS,LTZ,2,0*35`**Relevant Query Command** `$PASHQ,ZDA`**See also** `$PASHS,ZDA`

MDM,INI: Initializing the Modem

Function This command is used to initialize the modem.**Command Format Syntax**`$PASHS,MDM,INI[*cc]`**Parameters**

None.

Example

Initializing the modem:

`$PASHS,MDM,INI`

If modem initialization is successful, you will get the following answer:

`$PASHR,MDM,INI,OK*7A`

If modem initialization failed, you will get the following answer:

`$PASHR,MDM,INI,FAIL*7C`

Relevant Query Command \$PASHQ,MDM

See also \$PASHS,MDM,PAR

MDM,OFF: Powering Off the Internal Modem

Function This command is used to power off the internal modem. By default, the modem is off.

Command Format Syntax
 \$PASHS,MDM,OFF[*cc]

Parameters

None.

Example

Turning off the internal modem:

\$PASHS,MDM,OFF*52

Relevant Query Command \$PASHQ,MDM

See also \$PASHS,MDM,ON

MDM,ON: Powering On the Internal Modem

Function This command is used to power on the internal modem. By default, the modem is off.

Command Format Syntax
 \$PASHS,MDM,ON[*cc]

Parameters

None.

Example

Turning on the internal modem:

\$PASHS,MDM,ON*1C

Relevant Query Command \$PASHQ,MDM

See also \$PASHS,MDM,OFF

MDM,PAR: Setting the Modem Parameters

Function This command is used to set the modem parameters.

Command Format Syntax

\$PASHS,MDM,PAR[,PWR,s1][,PIN,s2][,BND,d3][,PTC,d4][,CBS,d5]
 [,APN,s6] [,LGN,s7][,PWD,s8][,IPT,d9][,PHN,s10][,ADL,c11]
 [,RNO,d12][,NET,d13][*cc]

Parameters

Parameter	Description	Range	Default
PWR,s1	Power mode: • AUT: Automatic • MAN: Manual	AUT, MAN	MAN
PIN,s2	PIN code	4-8 digits	Empty
BND,d3	Irrelevant to ProMark 800	-	-
PTC,d4	Not supported in ProMark 800	1	1
CBS,d5	Not supported in ProMark 800	-	-
APN,s6	Access Point Name (GPRS)	32 char. max.	Empty
LGN,s7	Login (GPRS)	32 char. max.	Empty
PWD,s8	Password (GPRS)	32 char. max.	Empty
IPT,d9	Internet Protocol: • 0: TCP • 1: UDP	0-1	0
PHN,s10	Not supported in ProMark 800	-	-

Parameter	Description	Range	Default
ADL,c11	Auto-dial mode. When this parameter is set to Yes (Y), the receiver will do the following when next turned on: <ul style="list-style-type: none"> • if d4=0, the phone number that the receiver was last communicating with will be re-dialed automatically. • if d4=1, a connection to the mount point or IP server to which the receiver was last connected will be initiated automatically. 	Y, N	Y
RNO,d12	Maximum number of re-dials	0-15	2
NET,d13	2G/3G selection: <ul style="list-style-type: none"> • 0: Automatic (2G or 3G) • 1: Forced to 2G 	0, 1	0
*cc	Optional checksum	*00-*FF	

Examples

Setting GPRS Configuration:

```
$PASHS,MDM,PAR,PWR,AUT,PIN,1234,APN,orange.fr,LGN,orange,PWD,orange,IPT,0,ADL,Y,NET,1*68
```

Relevant Query Command \$PASHQ,MDM

See also \$PASHS,DIP
 \$PASHS,NTR
 \$PASHS,MWD

MDP: Setting Port A to RS232 or RS422

Function This command is used to set port A as an RS232 or RS422 serial port.

Command Format **Syntax**
 \$PASHS,MDP,A,c[*cc]

Parameters

Parameter	Description	Range	Default
c	Port setting (RS232 or RS422)	232, 422	232
*cc	Optional checksum	*00-*FF	

Example

Setting port A to RS422:

```
$PASHS,MDP,A,422
```

Relevant Query Command \$PASHQ,MDP

See also \$PASHS,PRT
\$PASHS,CTS

MEM: Selecting Memory Device Used

Function This command is used to select the memory used by the receiver for data storage.

Command Format **Syntax**

```
$PASHS,MEM,d[*cc]
```

Parameters

Parameter	Description	Range	Default
d	Memory used: • 0: Internal memory (NAND Flash) • 2: USB mass storage key	0, 2	0
*cc	Optional checksum	*00-*FF	

Example

Selecting internal memory as the memory used by the receiver:

```
$PASHS,MEM,0*2C
```

Relevant Query Command \$PASHQ,MEM

See also \$PASHS,FIL,D
 \$PASHQ,FLS
 \$PASHQ,FIL,LST

MWD: Setting the Modem Timeout

Function This command is used to set the modem watchdog timeout. This parameter refers to the time during which the modem connection is active but no data is sent or received through the modem port. In case of timeout, the modem will hang up automatically.

Command Format **Syntax**
 \$PASHS,MWD,d[*cc]

Parameters

Parameter	Description	Range	Default
d	Timeout setting: <ul style="list-style-type: none"> • 1-99: Modem timeout in minutes. • 0: No timeout 	0-99	0
*cc	Optional checksum	*00-*FF	

Example

Setting the timeout to 5 minutes:

\$PASHS,MWD,5*32

Relevant Query Command \$PASHQ,MWD

See also \$PASHS,MDM,PAR
 \$PASHQ,FLS

NME: Enabling/Disabling NMEA Messages

Function This command is used to enable or disable NMEA messages and Ashtech NMEA-like messages.

Command Format Syntax

\$PASHS,NME,s1,c2,s3[,f4][*cc]

Parameters

Parameter	Description	Range
s1	Data message type	See tables below
c2	Port routing the message: <ul style="list-style-type: none"> • A: Serial port • C: Bluetooth • E: Modem • M, U: Internal memory (M), USB key (U) 	A, C, E, M, U
s3	Enables (ON) or disables (OFF) the message	ON, OFF
f4	Output rate: <ul style="list-style-type: none"> • Omitted: The message output rate will be as defined with \$PASHS,NME,PER • Setting \$PASHS,POP to "20" is a prior condition to operating at 0.05 s (20 Hz). f4 is not applicable to message PTT.	0.05 s or 0.1-0.4 s if [F] option activated. 0.5-0.9 s 1-999 s
*cc	Optional checksum	*00-*FF

NMEA messages:

Data	Description
ALM	GPS almanac data
DTM	Datum Reference
GGA	GPS fix data
GLL	Geographic position - Latitude / Longitude
GRS	GNSS range residual
GSA	GNSS DOP and active satellites
GST	GNSS pseudo-range error statistics
GSV	GNSS satellites in view
RMC	Recommended minimum specific GNSS data
VTG	Course over ground and ground speed
ZDA	Time and date

Ashtech NMEA-like messages:

Data	Description
CRT	Cartesian coordinates
DCR	Delta Cartesian
DDS	Differential decoder status
DPO	Delta position
LTN	Latency

Data	Description
POS	Position
PTT	1 PPS time tag
RRE	Residual error
SAT	Satellite status
SGA	Galileo satellite status
SGL	GLONASS satellite status
SGP	GPS and SBAS satellite status
VEC	Baseline vector

Example

Setting GGA message on Bluetooth port at 1-second output rate:

```
$PASHS,NME,GGA,C,ON,1*01
```

Comments

- For ALM messages, the f4 parameter can only take an integer value of seconds (by default 3600) and refers to the interval between messages related to the same satellite and with the same content.
- For a given satellite, the ALM messages are therefore renewed every “x” seconds (x=f4), or following a change in the message content (“on change”), whichever occurs first.
- ALM messages cannot be output more than once over a given period of 1 second.

Relevant Query Command

```
$PASHQ,NMO
```

See also

```
$PASHS,NME,PER
```

NME,ALL: Disabling All NMEA and NMEA-Like Messages

Function

This command is used to disable all NMEA messages and Ashtech NMEA-like messages currently enabled on the specified port.

Command Format

Syntax

```
$PASHS,NME,ALL,c1,OFF[*cc]
```

Parameters

Parameter	Description	Range
c1	Port ID A: Serial port C: Bluetooth port E: Modem M, U: Memory	A, C, E, M, U
*cc	Optional checksum	*00-*FF

Example

Disabling all NMEA and NMEA-like messages on port A:

```
$PASHS,NME,ALL,A,OFF*50
```

NME,PER: Setting Unique Output Rate for all NMEA Messages

Function

This command is used to set the same output rate for all NMEA and Ashtech NMEA-like messages. This command will overwrite all the output rates set individually for each message type using \$PASHS,NME,xxx.

Command Format

Syntax

```
$PASHS,NME,PER,f[*cc]
```

Parameters

Parameter	Description	Range	Default
f	Output rate. Setting \$PASHS,POP to "20" is a prior condition to operating at 0.05 s (20 Hz).	0.05 s or 0.1-0.4 s with [F] option activated. 0.5-0.9 s 1-999 s	1 s
*cc	Optional checksum	*00-*FF	

Example

Setting the output rate to 1 second:

```
$PASHS,NME,PER,1*45
```

Relevant Query Command

```
$PASHQ,NMO
```

See also

```
$PASHS,NME
```

\$PASHS,POP

NPT: Tagging SBAS Differential Positions in NMEA & NMEA-Like Messages

Function This command allows you to define the code the receiver will insert in each of its NMEA-like or NMEA messages to tell that the position solution inserted in the message is of the SBAS Differential type.

Command Format **Syntax**
\$PASHS,NPT,d1,d2[*cc]

Parameters

Parameter	Description	Range	Default
d1	Code assigned to SBAS differential position solution in NMEA-like messages (CRT, DCR, DPO, POS, VEC): <ul style="list-style-type: none"> • 0: Code "1" • 1: Code "9" 	0,1	0
d2	Code assigned to SBAS differential position solution in NMEA messages (GGA): <ul style="list-style-type: none"> • 0: Code "2" • 1: Code "9" 	0, 1	0
*cc	Optional checksum	*00-*FF	

Example

Tagging SBAS Differential position solutions in NMEA-like and NMEA messages with code "9":

\$PASHS,NPT,1,1*3F

Relevant Query \$PASHQ,NPT
Commands \$PASHQ,PAR

NTR,LOD: Loading the NTRIP Caster Source Table

Function This command is used to load the source table from the NTRIP caster.

Command Format **Syntax**
`$PASHS,NTR,LOD[*cc]`

Parameters
None.

Example
Loading the source table:
`$PASHS,NTR,LOD`

If the source table is downloaded successfully, the following response line will be returned:

`$PASHR,NTR,OK*14`

If the receiver fails to download the source table, the following response line will be returned:

`$PASHR,NTR,FAIL*12`

Relevant Query Command None.

See also `$PASHQ,NTR,TBL`
`$PASHS,NTR,PAR`

NTR,MTP: Connecting Receiver to NTRIP Caster Mount Point

Function This command allows you to connect the receiver to a NTRIP caster mount point.

Command Format Syntax

\$PASHS,NTR,MTP,s1[*cc]

Parameters

Parameter	Description	Range
s1	Name of the NTRIP mount point, or OFF command (ending the connection to the current mount point).	100 characters max., or OFF
*cc	Optional checksum	*00-*FF

Example

Connecting to mount point MUWFO:

\$PASHS,NTR,MTP,MUWFO*4D

If the connection is successful, the following response line will be returned:

\$PASHR,NTR,OK*cc

If the connection failed, the following response line will be returned:

\$PASHR,NTR,FAIL*12

Relevant Query Command None.

See also \$PASHQ,NTR,TBL

NTR,PAR: NTRIP Settings

Function This command allows you to set all the NTRIP parameters.

Command Format Syntax

`$PASHS,NTR,PAR[,ADD,s1][,PRT,d2][,LGN,s3][,PWD,s4][,TYP,d5]*cc]`

Parameters

Parameter	Description	Range
ADD,s1	Caster IP address or host name	000.000.000.000-255.255.255.255 or www.....
PRT,d2	Caster port number	0-65535
LGN,s3	Login	32 characters max.
PWD,s4	Password	32 characters max.
TYP,d5	Caster type: <ul style="list-style-type: none"> • 0: Client • 1: Server 	0-1
*cc	Optional checksum	*00-*FF

Example

Entering NTRIP settings for a client caster by specifying its IP address, port number, login and password:

`$PASHS,NTR,PAR,ADD,192.34.76.1,PRT,2100,LGN,Ashtech,PWD,u6huz8,TYP,0*52`

Relevant Query Commands \$PASHQ,NTR
\$PASHQ,PAR

See Also \$PASHS,NTR,MTP
\$PASHS,NTR,LOD

OCC: Writing Occupation Data to Raw Data File

Function This command is used to write information about the current occupation to the raw data file being logged.

Command Format Syntax

```
$PASHS,OCC,d1,d2,s3[,s4][*cc]
```

Parameters

Parameter	Description	Range
d1	Occupation type: <ul style="list-style-type: none"> • 0: Static • 1: Quasi-static • 2: Dynamic • 3: Event • 4: On kinematic bar, 20 cm long 	0-4
d2	Occupation event: <ul style="list-style-type: none"> • 0: Begin • 1: End 	0-1
s3	Occupation name	255 characters max.
s4	Occupation description	255 characters max.
*cc	Optional checksum	*00-*FF

Examples

Starting a static occupation on point "SITE01":

```
$PASHS,OCC,0,0,SITE01,Park_Entrance*63
```

Ending the static occupation on point "SITE01":

```
$PASHS,OCC,0,1,SITE01,Park_Entrance*62
```

Relevant Query Command \$PASHQ,OCC

See also \$PASHS,REC
\$PASHS,ATM

OPTION: Receiver Firmware Options

Function This command is used to install the receiver firmware options that have been purchased after the initial receiver purchase. Options purchased at the time of receiver purchase are factory pre-loaded.

Command Format Syntax

```
$PASHS,OPTION,c1,h2[*cc]
```

Parameters

Parameter	Description	Range
c1	Option ID	K, F, Z, S, P, M, L, N, C, O, Q R (See table below)
h2	Hexadecimal unlock code	13 characters max.
*cc	Optional checksum	*00-*FF

Option ID	Label	Description
#	REGISTRATION CODE	Depends on the firmware version installed. This is a mandatory code. If absent, all options become invalid.
K	RTK	Enables RTK processing. Corrections generated in RTCM2.3, RTCM3.0, CMR or CMR+ format.
F	FASTOUTPUT	Enables data output at 20 Hz
Z	MODEM	Enables the GSM/GPRS modem
S	GLONASS	Enables GLONASS
P	GNSSSL2	Enables L2 tracking
M	RTK2	Enables RTK using proprietary data formats (ATOM, DBEN or LRK)
L	RTK3	Enables limited RTK range
N	STA	Enables RTK base
O	GALILEO	Enables Galileo tracking
Q	GNSSSL5	Enables L5 tracking

NOTE: Options K, M and L are also relevant to a base.

Comments

- When activating GLONASS or GNSSSL2, it is essential that you modify the receiver configuration, using \$PASHS,GPS and \$PASHS,GLO to enable the tracking of the new

signals. Alternatively, you can run `$PASHS,RST` to update the default configuration, taking into account all the activated firmware options.

- Firmware options may be activated for limited periods of time, depending on the type of unlock code generated for each of them. Several validity times are possible:
 - Permanent
 - 6 months
 - 3 months
 - 1 month
 - 30 days
 - 15 days
 - 8 days

Example

Enabling the RTK option:

```
$PASHS,OPTION,K,878A8874*48
```

Relevant Query Command `$PASHQ,OPTION`

See also `$PASHQ,RID`

PAR,LOD: Configuring the Receiver From a PAR File

Function This command configures the receiver in one step, using the data stored in the specified PAR file. The PAR file may have been saved previously to the receiver's internal memory or on a USB key.

Command Format **Syntax**
`$PASHS,PAR,LOD[,d1][,s2][*cc]`

Parameters

Parameter	Description	Range	Default
d1	Memory where the PAR file can be found: <ul style="list-style-type: none"> • 0: Internal memory (NAND Flash) • 2: USB key If d1 is omitted, the receiver will assume that the PAR file is on the USB key.	0, 2	2
s2	File name (PM_SSSSS_dddhhmss.par) where: <ul style="list-style-type: none"> • SSSSS: Last 5 digits from serial number • ddd: Day number (1.. 366) • hhmmss: Time If s2 is omitted, the receiver checks that only one PAR file is found in the specified memory. If that is the case, the receiver will be configured according to this file. If several PAR files are found, then \$PASHR,NAK will be returned and the receiver will keep its current configuration.	-	-
*cc	Optional checksum	*00-*FF	-

Examples

Changing the receiver configuration by loading the PAR file saved on the USB memory:

```
$PASHS,PAR,LOD*5D
```

Changing the receiver configuration by loading the PAR file named "PM_95685_145084518.par" located in the internal memory:

```
$PASHS,PAR,LOD,0,PM_95685_145084518.par*1A
```

Relevant Query Command None.

See also \$PASHS,PAR,SAV

PAR,SAV: Saving the Receiver Configuration To a PAR File

Function This command is used to save the current receiver configuration to a PAR file.

Command Format Syntax

```
$PASHS,PAR,SAV[,d1][*cc]
```

Parameters

Parameter	Description	Range	Default
d1	Memory where the PAR file will be written: <ul style="list-style-type: none"> • 0: Internal memory (NAND Flash) • 2: USB key If d1 is omitted, the receiver will assume that the PAR file should be saved to the USB key.	0, 2	2
*cc	Optional checksum	*00-*FF	-

Comments

The command will create a PAR file named as follows:

```
PM_SSSSS_dddhhmss.par
```

Where:

- SSSSS: Last 5 digits from receiver serial number
- ddd: Day number (1.. 366)
- hhmmss: Current time

The command will be rejected (\$PASHR,NAK) in the following cases:

- No USB key detected and d1=2 or is omitted
- Not enough space available on the specified memory
- The PAR file already exists.

Example

Saving the receiver configuration to the USB key:

```
$PASHS,PAR,SAV*5E
```

Relevant Query Command

None.

See also

```
$PASHS,PAR,LOD
```

PEM: Setting the Position Elevation Mask

Function This command is used to set the elevation mask used in the position processing.

Command Format Syntax
\$PASHS,PEM,d1[*cc]

Parameters

Parameter	Description	Range	Default
d1	Elevation mask angle, in degrees	0-90°	5
*cc	Optional checksum	*00-*FF	

Example

Setting the elevation mask for position processing to 15 degrees:

\$PASHS,PEM,15*05

Relevant Query Command \$PASHQ,PEM

See also \$PASHS,ELM

POP: Setting Internal Update Rate for Measurements and PVT

Function This command allows you to set the updates rate used internally in the measurements and position processing.

Command Format Syntax
\$PASHS,POP,d[*cc]

Parameters

Parameter	Description	Range	Default
d	Internal update rate, in Hz, for measurements and PVT.	10, 20	20
*cc	Optional checksum	*00-*FF	

Example

Setting the update rate to 10 Hz:

```
$PASHS,POP,20*17
```

Comments

- Outputting data at 20 Hz through \$PASHS,NME, \$PASHS,ATM and \$PASHS,RAW requires that the present update rate stays at 20 Hz (default value).
- Changing the update rate causes GNSS reception to be reset (the number of received/used satellites drops to 0 straight away and then rapidly comes back to normal).

Relevant Query Command \$PASHQ,POP

See Also \$PASHS,NME
 \$PASHS,ATM
 \$PASHS,RAW

POS: Setting the Antenna Position

Function This command allows you to enter the geographic coordinates of the GNSS antenna. It is usually used to enter the position of a base. If there is no computed position available from the receiver when the command is applied, then the entered position is used to initialize the receiver position in order to speed up satellite tracking.

Depending on the last \$PASHS,ANR command applied to the receiver, the antenna position you enter will be either that of the phase center, the ARP or the ground mark.

Command Format Syntax
 \$PASHS,POS,m1,c2,m3,c4,f5[*cc]

Parameters

Parameter	Description	Range
m1	Latitude in degrees and minutes with 7 decimal places (ddmm.mmmmmmm)	0-90
c2	North (N) or South (S)	N, S
m3	Longitude in degrees, minutes with 7 decimal places (ddmm.mmmmmmm)	0-180
c4	West (W) or East (E)	W, E
f5	Height in meters	±0-9999.9999
*cc	Optional checksum	*00-*FF

Example

Setting the antenna position to 37°22.2912135'N, 121°59.7998217'W and 15.25 m:

\$PASHS,POS,3722.2912135,N,12159.7998217,W,15.25*1F

Comments

The \$PASHS,POS command will be NAKed if the entered position is too distant from the computed one.

Relevant Query Command \$PASHQ,CPD,POS

See also \$PASHS,CPD,MOD,BAS
\$PASHS,ANH
\$PASHS,ANR

PPS: Setting PPS Pulse Properties

Function This command is used to set the period, offset and GPS synchronized edge (rising or falling) of the PPS pulse.

Command Format Syntax

\$PASHS,PPS,f1,f2,c3[*cc]

Parameters

Parameter	Description	Range	Default
f1	PPS time period, a multiple or fraction of 1 second. • 0: 1 PPS disabled	0 to 1, with 0.1-sec increments 1 to 60, with 1-sec increments	0
f2	Time offset in milliseconds.	± 999.9999	0
c3	GPS-synchronized edge code: • "R" for rising edge • "F" for falling edge	R, F	R
*cc	Optional checksum	*00-*FF	

Example

Setting the PPS signal to a period of 2 seconds, with an offset of 500 ms and a GPS-synchronized rising edge:

```
$PASHS,PPS,2,+500,R*74
```

Relevant Query Command \$PASHQ,PPS

See Also \$PASHS,NME (PTT)

PRT: Setting Baud Rates

Function This command is used to set the baud rate of any of the serial ports used in the receiver.

Command Format **Syntax**

```
$PASHS,PRT,c1,d2[*cc]
```

Parameters

Parameter	Description	Range
c1	Port ID	A, D
d2	Baud rate	Port A: 0-15; Port D: 0-9 (see table below)
*cc	Optional checksum	*00-*FF

Code	Baud Rate	Code	Baud Rate
0	300	7	38400

Code	Baud Rate	Code	Baud Rate
1	600	8	57600
2	1200	9	115200
3	2400	10	230400
4	4800	11	480600
5	9600	12	921600
6	19200	13	1428571

Example

Setting port A to 19200 Bd:

```
$PASHS,PRT,A,6
```

Relevant Query Command \$PASHQ,PRT

See also \$PASHS,CTS
\$PASHS,MDP

PWR,OFF: Powering Off the Receiver

Function This command is used to power off the receiver.

Command Format Syntax
\$PASHS,PWR,OFF[*cc]

Parameters

None.

Example

Turning off the receiver

```
$PASHS,PWR,OFF*43
```

Relevant Query Command None.

PWR,PAR: Power Management

Function This command is used to set the voltage thresholds triggering low-power alarms.

Command Format Syntax

\$PASHS,PWR,PAR,f1,f2[*cc]

Parameters

Parameter	Description	Range	Default
f1	Battery voltage threshold, in volts, triggering a low-battery alarm	6.7-8.4	6.8
f2	External power voltage threshold, in volts, triggering a low-power alarm	9.0-28.0	9.1
*cc	Optional checksum	*00-*FF	-

Example

Setting the thresholds to respectively 7 and 9 V:

\$PASHS,PWR,PAR,7,9*41

Relevant Query Command \$PASHQ,PWR

RAW: Enabling/Disabling Raw Data Messages in Legacy Ashtech Format

Function This command is used to enable or disable the standard, continuous output of raw data in legacy Ashtech format.

Command Format Syntax

\$PASHS,RAW,s1,c2,s3[,f4][*cc]

Parameters

Parameter	Description	Range	Default
s1	Raw data message type	See table below	
c2	Port routing the raw data message: <ul style="list-style-type: none"> • A: Serial port • C: Bluetooth port • M: Internal memory • U: External memory (USB) 	A, C, M, U	-
s3	Enables (ON) or disables (OFF) the raw data message	ON, OFF	OFF
f4	Output rate in seconds. Keeping \$PASHS,POP at "20" is the necessary condition to operating at 0.05 s (20 Hz).	0.05 s or 0.1-0.4 s with [F] option activated. 0.5-0.9 s, 1-999 s	1
*cc	Optional checksum	*00.*FF	

Raw data message types:

Data	Description
MPC	GPS/GLONASS/SBAS measurements
DPC	Compact GPS raw data
PBN	Position information
SNV	GPS ephemeris data
SNG	GLONASS ephemeris data
SNW	SBAS ephemeris data
SAL	GPS almanac data
SAG	GLONASS almanac data
SAW	SBAS almanac data
ION	Ionospheric parameters
SBD	SBAS data message

Examples

Enabling output of MPC message type on port A to 1 second:

```
$PASHS,RAW,MPC,A,ON,1*1E
```

Enabling output of SNV message type on port A to 300 seconds:

```
$PASHS,RAW,SNV,A,ON,300*09
```

Comments

- For each of the SNV, SNG, SNW, SAL, SAG, SAW and ION messages, the f4 parameter can only take an integer value

of seconds and refers to the interval between messages related to the same satellite and with the same content. For a given satellite, each of these messages is therefore renewed every x seconds (where $x=f4$), or following a change in the message content (“on change”), whichever occurs first.

Each of these messages cannot be output more than once over a given period of 1 second.

- By default, $f4$ is set as follows:

Output message	f4 Default Value
SNV, SNG, ION	900
SAL, SAG	3600
SNW	120
SAW	300

- The SBD message output rate is always 1 second (as decoded). Parameter $f4$ is ignored.

Relevant Query Command \$PASHQ,RAW
 \$PASHQ,RWO

See also \$PASHS,RAW,PER
 \$PASHS,RAW,ALL
 \$PASHS,POP

RAW,ALL: Disabling All Raw Data Messages

Function This command is used to disable all the currently active raw data messages on the specified port.

Command Format **Syntax**
 \$PASHS,RAW,ALL,c1,OFF[*cc]

Parameters

Parameter	Description	Range
c1	Port ID <ul style="list-style-type: none"> Serial port: A Bluetooth port: C Memory: M, U 	
*cc	Optional checksum	*00-*FF

Example

Disabling all raw data messages on port A:

```
$PASHS,RAW,ALL,A,OFF*52
```

Relevant Query Command None.

See Also \$PASHS,RAW

RAW,PER: Setting Unique Output Rate for Raw Data

Function This command is used to set the same output rate for raw data messages MPC, DPC and PBN. This command will overwrite the output rates set individually for each of these message types using \$PASHS,RAW,xxx. Setting this rate does not affect the data recording rate (set with \$PASHS,DR1).

Command Format Syntax

```
$PASHS,RAW,PER,f[*cc]
```

Parameters

Parameter	Description	Range	Default
f	Output rate, in seconds. Setting \$PASHS,POP to "20" is a prior condition to operating at 0.05 s (20 Hz).	0.05 s or 0.1-0.4 s with [F] option activated. 0.5-0.9 s 1-999 s	1 s
*cc	Optional checksum	*00-*FF	

Example

Setting the data output rate to 2 seconds:

```
$PASHS,RAW,PER,2*44
```

Relevant Query Command \$PASHQ,RAW

See also \$PASHS,RAW
 \$PASHS,RAW,ALL
 \$PASHS,POP

RCP,GBx: GLONASS Carrier Phase Biases for User-Defined Receiver

Function This set of two commands is used to define GLONASS carrier phase biases for a given receiver. One command deals with the GLONASS L1 band and the other with the GLONASS L2 band.

Command Format Syntax

For the L1 band:

`$PASHS,RCP,GB1,s1,f2,f3,f4,f5,f6,f7,f8,f9,f10,f11,f12,f13,f14,f15,f16,f17[*cc]`

For the L2 band:

`$PASHS,RCP,GB2,s1,f2,f3,f4,f5,f6,f7,f8,f9,f10,f11,f12,f13,f14,f15,f16[*cc]`

Parameters

Parameter	Description	Range
s1	Name of user-defined receiver for which GLONASS biases must be defined (case sensitive)	31 characters max.
f2	When a linear pattern is assumed for GLONASS biases, f2 represents the delta bias between two adjacent GLONASS frequency numbers.	Full range of Real variables allowed
f3-f16	When an arbitrary pattern is assumed for GLONASS biases, f3-f16 represent biases for GLONASS frequency numbers from -7 to 6	Full range of Real variables allowed
f17	Pseudo-range bias (in meters) between GPS and GLONASS constellations	
*cc	Optional checksum	*00-*FF

Comments

- **Only fractional parts of GLONASS carrier phase biases are of practical importance.**
- Running one of these commands on a receiver already stored in the list of user-defined receivers will save all the

submitted parameters to permanent memory and keep all the others unchanged.

- You may not run the two commands (GB1 and GB2) for a given user-defined receiver. If you run just one of them, then the parameters corresponding to the other command will all be assumed to be invalid (i.e unknown). All user-defined receivers created from this receiver will also inherit these invalid parameters.
- The board will interpret any missing parameter in a command as a parameter for which there is currently no known valid value for this parameter.

Relevant Query Command \$PASHQ,RCP

See Also \$PASHS,RCP,DEL

RCP,DEL: Deleting User-Defined Receiver Name

Function This command is used to delete a user-defined receiver name.

Command Format Syntax

\$PASHS,RCP,DEL,s1[*cc]

Parameters

Parameter	Description	Range
s1	Receiver name you want to delete (case sensitive)	31 characters max.
*cc	Optional checksum	*00-*FF

Example

Deleting receiver name "MyReceiver":

\$PASHS,RCP,DEL,MyReceiver*74

Relevant Query Command \$PASHQ,RCP

See Also \$PASHS,RCP,GB1
\$PASHS,RCP,GB2

RCP,REF: Naming Reference Receiver

Function This command is used to enter the reference receiver name.

Command Format Syntax
\$PASHS,RCP,REF,s1[,d2][*cc]

Parameters

Parameter	Description	Range	Default
s1	Receiver name (case-sensitive).	31 characters max.	Empty
d2	Receiver name preference: <ul style="list-style-type: none"> • 0: s1 is ignored if the incoming reference data contain the reference receiver name • 1: s1 is always used and the decoded reference receiver name is ignored. 	0 or 1	0
*cc	Optional checksum	*00-*FF	

Comment

The supported receiver models are listed below (these are case-sensitive names):

ASHTECH
ProMark800
ProMark500
ProFlex500
MB500
PM5
MMapper100
ProMark100
MB100
NOVATEL
TRIMBLE
SEPTENTRIO
TOPCON
JAVAD

Example

Entering “Ashtech” as the name of the reference receiver:

\$PASHS,RCP,REF,Ashtech*25

Relevant Query Commands \$PASHQ,RCP,REF
 \$PASHQ,RCP

See Also \$PASHS,ANP,REF

RDP,OFF: Powering Off the Internal Radio

Function This command is used to power off the internal radio.

Command Format **Syntax**
 \$PASHS,RDP,OFF[*cc]

Parameters
None.

Example
Turning off the internal radio:
 \$PASHS,RDP,OFF*50

Relevant Query Command \$PASHQ,RDP,PAR,D

See also \$PASHS,RDP,ON
 \$PASHS,RDP,PAR

RDP,ON: Powering On the Internal Radio

Function This command is used to power on the internal radio.

Command Format **Syntax**
 \$PASHS,RDP,ON[*cc]

Parameters
None.

Example
Turning on the internal radio:
 \$PASHS,RDP,ON*1E

Relevant Query Command \$PASHQ,RDP,PAR,D

See also \$PASHS,RDP,OFF
\$PASHS,RDP,PAR

RDP,PAR: Setting the Radio

Function This command is used to set the radio connected to the specified port.

Command Format Syntax

\$PASHS,RDP,PAR,c1,s2,d3,[s4],[c5],[d6],[s7],[c8],[c9][s10][*cc]

Parameters

Parameter	Description	Range
c1	ID of the port connected to the radio you want to set.	A, D
s2	Radio Model: <ul style="list-style-type: none"> • PDL (Pacific Crest): <ul style="list-style-type: none"> • PDL RXO (internal, port D) • PDL HPB/LPB (external, port A) • ADL (Pacific Crest): <ul style="list-style-type: none"> • ADL RXO (internal, port D) • ADL Vantage (external, port A) • MGL: Radio transmitter P/N 800986 • MDL: U-Link • LFE: License-free radio, Europe (ARF7474B) • LFA: License-free radio, North America (ARF7474A) 	PDL, MGL, MDL, LFE, LFA, ADL (port A) PDL, MDL, ADL (port D)
d3	Channel number: <ul style="list-style-type: none"> • 0-15 (PDL, MDL, MGL) • 1-32 (ADL) • 0-2 (LFE) • 0-49 (LFA) 	0-49
s4	Power management (if port D is used) <ul style="list-style-type: none"> • AUT: Automatic • MAN: Manual 	AUT, MAN

Parameter	Description	Range
c5	Protocol used: PDL: <ul style="list-style-type: none"> • 0: Transparent • 1: TRIMTALK • 2: DSNP MDL: <ul style="list-style-type: none"> • 0: Transparent • 1: Not used • 2: DSNP ADL: <ul style="list-style-type: none"> • 0: Transparent (w EOT time out) • 1: TRIMTALK 450S • 2: Not used • 3: SATEL • 4: TrimMarkII/Ile • 5: TT450S (HW) • 6: TRIMMARK3 • 7: Transparent FST 	0-7
d6	Air link speed (in baud): PDL: <ul style="list-style-type: none"> • 4800 (GMSK modulation) • 9600 (GMSK or 4FSK modulation) • 19200 (4FSK modulation) MDL: <ul style="list-style-type: none"> • 4800 • 7600 • 9600 ADL, 12.5 kHz: <ul style="list-style-type: none"> • 4800 (GMSK modulation) • 8000 (GMSK modulation) • 9600 (4FSK modulation) ADL, 25 kHz: <ul style="list-style-type: none"> • 4800 (GMSK modulation) • 9600 (GMSK modulation) • 16000 (GMSK modulation) • 19200 (4FSK modulation) 	4800, 7600, 8000, 9600, 16000, 19200
s7	Radio sensitivity (PDL, ADL and MDL only)	LOW, MED, HIG, OFF
c8	Scrambler (PDL and ADL only): <ul style="list-style-type: none"> • 0: Off • 1: On 	0, 1
c9	Forward Error Correction (PDL and ADL only): <ul style="list-style-type: none"> • 0: FEC Off • 1: Hamming FEC On 	0,1

Parameter	Description	Range
s10	Transmission power (ADL Vantage only): <ul style="list-style-type: none"> • 0: 100 mW • 1: 500 mW • 2: 1 W • 3: 2 W • 4: 4 W 	0-4
*cc	Optional checksum	*00-*FF

Comments

- The command will be NAKed if the receiver has not been told on which port the radio is connected. Use command \$PASHS,RDP,TYP to declare the port used.
- **If a PDL radio is used**, depending on its channel spacing, the air link speed you select may force the use of a particular type of modulation and protocol, as well as a particular FEC setting. The different possible combinations are summarized in the table below.

Channel Spacing is:	You set c6 to:	Then modulation can only be:	Protocol can only be:	FEC Setting
12.5 kHz	4800	GMSK	The 3 protocols are possible.	May be set to ON for Transparent protocol (FEC1). Forced to OFF for the other two protocols.
12.5 kHz	8000	Command NAKed		
12.5 kHz	9600	4FSK	Transparent	May be set to ON (FEC1)
25 kHz	4800	GMSK	TRIMTALK or DSNP	Forced to OFF
25 kHz	8000	Command NAKed		
25 kHz	9600	GMSK	TRIMTALK or Transparent	Forced to OFF for TRIM-TALK. May be set to ON for Transparent protocol (FEC1).
25 kHz	16000	Command NAKed		
25 kHz	19200	4FSK	Transparent	May be set to ON (FEC1)

Conversely, the choice of a protocol or modulation may force the use of a particular air link speed.

- **If an ADL radio is used**, depending on its channel spacing, the air link speed you select may force the use of a particular type of modulation and protocol, as well as a

particular FEC setting. The different possible combinations are summarized in the table below.

Channel Spacing is:	You set c6 to:	Then modulation can only be:	Protocol can only be:	FEC Setting
12.5 kHz	4800	GMSK	Transparent, TRIMALK 450S, TT450S (HW) or TrimMark II/Ile.	Maybe set to ON for Transparent protocol (FEC1). Forced to OFF for the other three.
12.5 kHz	8000	GMSK	TRIMALK 450S or TT450S (HW)	Forced to OFF
12.5 kHz	9600	GMSK	TrimMark3	Forced to OFF
		4FSK	Transparent, SATEL or Transparent FST	May be set to ON (FEC 1 for Transparent protocol, FEC2 for the other two)
25 kHz	4800	GMSK	TRIMTALK 450S, TT450S (HW) or Trim-Mark II/Ile	Forced to OFF
25 kHz	8000	Command NAKed		
25 kHz	9600	GMSK	Transparent, TrimTalk 450S or TT450S (HW)	May be set to ON for Transparent protocol (FEC1). Forced to OFF for the other two.
25 kHz	16000	GMSK	TrimTalk 450S or TT450S (HW)	Forced to OFF
25 kHz	19200	GMSK	TrimMark3	Forced to OFF
		4FSK	Transparent, SATEL or Transparent FST	May be set to ON (FEC 1 for Transparent protocol, FEC2 for the other two)

Conversely, the choice of a protocol or modulation may force the use of a particular air link speed.

- **If an MDL radio is used** and the DSNP protocol is selected, only the 4800 Bd baud rate can be used.
- **If an LFE radio is used**, the relationship between its channel number and frequency is given in the table below.

Channel Number	Frequency (MHz)
0	869.450 (manufacturer's channel 19)
1	869.525 (manufacturer's channel 84)

Channel Number	Frequency (MHz)
2	869.600 (manufacturer's channel 85)

Examples

Setting the internal Pac Crest radio receiver:

```
$PASHS,RDP,PAR,D,PDL,2,AUT,0,9600,LOW,0,0*75
```

Setting the internal U-Link Rx:

```
$PASHS,RDP,PAR,D,MDL,0,AUT,0,9600,LOW*6A
```

Setting the external U-Link TRx:

```
$PASHS,RDP,PAR,A,MDL,1*45
```

Relevant Query Command \$PASHQ,RDP,PAR

See also \$PASHS,RDP,ON
 \$PASHS,RDP,OFF
 \$PASHS,RDP,TYP
 \$PASHQ,RDP, CHT

RDP,TYP: Defining the Type of Radio and the Receiver Port Used

Function This command is used to set manually the type of radio connected to the specified port. Normally, the type of internal radio (typically connected to port D) is detected automatically.

If you change physically the internal radio of the receiver, you may send command \$PASHS,RDP,TYP,D,UNKNOWN or reset the receiver configuration so that the receiver can detect automatically the new internal radio.

Command Format Syntax

```
$PASHS,RDP,TYP,c1,s2[*cc]
```

Parameters

Parameter	Description	Range
c1	ID of the port connected to the radio you want to set.	A, D
s2	Radio Model: <ul style="list-style-type: none"> • UNKNOWN: Auto-detection (port D only) • NONE: No radio • PDL: Pacific Crest radio <ul style="list-style-type: none"> • Internal (port D): PDL RXO • External (port A): PDL HPB/LPB • ADL: Pacific Crest radio <ul style="list-style-type: none"> • Internal (port D): ADL RXO • External (port A): ADL Vantage • MGL: Radio transmitter P/N 800986 • MDL: U-Link • LFE: License-free radio, Europe (ARF7474B) • LFA: License-free radio, North America (ARF7474A) 	Port A: NONE, PDL, MGL, MDL, LFE, LFA, ADL. Port D: UNKNOWN, NONE, PDL, MDL or ADL.
*cc	Optional checksum	*00-*FF

Examples

Auto-detecting the internal radio receiver:

```
$PASHS,RDP,TYP,D,UNKNOWN*4E
```

Setting the external radio as an Ashtech U-Link TRx:

```
$PASHS,RDP,TYP,A,MDL*46
```

Relevant Query Command \$PASHQ,RDP,TYP

See also \$PASHS,RDP,PAR
 \$PASHS,RDP,ON
 \$PASHQ,RDP, OFF

REC: Enable/Disable, Start/Stop Raw Data Recording

Function This command allows you to enable, disable, start or stop raw data recording. Raw data is recorded in the memory you selected with the \$PASHS,MEM command.

Command Format Syntax**\$PASHS,REC,c[*cc]****Parameters**

Parameter	Description	Range
c	Control character: <ul style="list-style-type: none"> Y: Yes. The receiver will immediately start recording data. This option also enables data recording at receiver power-up, i.e. recording will start every time you turn the receiver on, even if you stopped recording before the end of the previous session. N: No. The receiver will immediately stop recording data. This option also disables data recording at receiver power up, i.e. the receiver won't resume data recording when you next turn it on. This is the default mode. S: Stop. The receiver will immediately stop recording raw data. This option does not affect the way the receiver operates at power-up. R: Restart. The receiver will immediately start recording raw data. This option does not affect the way the receiver operates at power-up. 	Y, N, S, R
*cc	Optional checksum	*00-*FF

Examples

Starting raw data recording:

\$PASHS,REC,Y*54

Stopping raw data recording:

\$PASHS,REC,N*43**Relevant Query Command**

\$PASHQ,REC

See also

\$PASHS,MEM

\$PASHS,ATM

\$PASHS,NME

\$PASHS,RFB (Ring File Buffer)

RNX,TYP: ATOM RNX Differential Message

Function This command is used in a receiver used as a base to define the type and output rate of the ATOM RNX message generated by the base.

This command is now used as a replacement to the \$PASHS, ATD,TYP command, which was made obsolete in May 2010.

Command Format Syntax

```
$PASHS,RNX,TYP,d1,d2[,d3][*cc]
```

Parameters

Parameter	Description	Range	Default
d1	Scenario number	See table below	4
d2	Output rate for observations, in seconds.	0.1-0.4 if [F] option activated. 0.5-0.9 1-1800	1
d3	Output rate for attributes (receiver and antenna names), in seconds.	0:Disabled 1-1800	31
*cc	Optional checksum	*00-*FF	

Scenario Number	Description
0	All available raw data in full presentation, full computed reference position follows at each epoch. This scenario is not recommended for use as differential protocol.
1	L1 pseudo-range and carrier phase in full presentation, extended fixed position follows each 12 epochs.
2	L1 SNR, pseudo-range and carrier phase in full presentation, extended fixed position follows each 12 epochs.
3	L1&L2 pseudo-range and carrier phase in full presentation, extended fixed position follows each 12 epochs.
4	L1 &L2 SNR, pseudo-range and carrier phase in full presentation, extended fixed position follows each 12 epochs.
100	L1&L2 compact pseudo-range and full carrier phase, extended fixed position follows each 12 epochs, all the data are decimated in 5 times compared to L1 carrier phase.

Scenario Number	Description
101	L1&L2 compact pseudo-range and compact carrier phase, extended fixed position follows every 12 epochs, all the data are decimated in 5 times compared to L1 carrier phase. This scenario cannot be used with a moving receiver.
201	Same as scenario 1, but extended computed reference position follows each epoch.
202	Same as scenario 2, but extended computed reference position follows each epoch.
203	Same as scenario 3, but extended computed reference position follows each epoch.
204	Same as scenario 4, but extended computed reference position follows each epoch.
300	Same as scenario 100, but extended computed reference position follows each epoch.

Example

Choosing scenario 4 with 1 sec and 30 sec for the output rates:

```
$PASHS,RNX,TYP,4,1,30*6A
```

Relevant Query Command \$PASHQ,RNX,MSI

See Also \$PASHS,BAS
\$PASHS,CPD,MOD,BAS

RST: Default Settings

Function This command is used to reset the receiver parameters to their default values.

Command Format Syntax
\$PASHS,RST[*cc]

Parameters

None.

Example

Resetting the receiver:

```
$PASHS,RST*20
```

Comments The following GSM parameters are not affected by the \$PASHS,RST command:

- PIN code
- Access Point Name (GPRS)
- Login (GPRS)
- Password (GPRS)
- Net (automatic 2G/3G, or forced to 2G)

Relevant Query Command None.

See also \$PASHS,INI

RTC,MSG: Defining a User Message

Function This command is used to input a user message that a base will be able to forward to a rover through RTCM message type 16, 36 or 1029. This command can only be applied to a base receiver with message type 16 or 1029 enabled in the receiver.

Command Format Syntax
\$PASHS,RTC,MSG,s[*cc]

Parameters

Parameter	Description	Range
s	User message	90 characters max.
*cc	Optional checksum	*00-*FF

Example

Submitting a user message:

\$PASHS,RTC,MSG,<user message 90 characters max>

Relevant Query Command None.

See also \$PASHS,RTC,TYP
\$PASHS,BAS
\$PASHS,CPD,MOD,BAS

RTC,TYP: RTCM Message Type

Function This command is used to choose the RTCM messages type that will be generated and broadcast by a base receiver as well as its output rate. This command can only be applied to a base receiver.

Command Format Syntax

\$PASHS,RTC,TYP,d1,d2[*cc]

Parameters

Parameter	Description	Range
d1	Message type	0-36, 1000-1033, see tables below
d2	Output rate, in seconds, or "0" for message disabled	0, 0.1-0.4 (with [F] option activated) 0.5-0.9, 1-1800
*cc	Optional checksum	*00-*FF

RTCM 2.3 messages:

Parameter	Description	Default
0	Disables all RTCM 2.3 messages	-
1	Differential GPS corrections	0
3	GPS reference station parameters	0
9	GPS partial correction set	0
16	GPS special message	0
18	RTK uncorrected carrier phase (18) RTK uncorrected pseudoranges (19)	1
20	RTK carrier phase correction (20) RTK high-accuracy, pseudorange corrections (21)	0
22	Extended reference station parameter	0
23	Antenna type definition record	31 s
24	Antenna reference point	13 s
31	Differential GLONASS corrections	0
32	Differential GLONASS reference station parameters	0
34	GLONASS partial correction set	0
36	GLONASS special message	0

RTCM 3.0 & 3.1 messages:

Parameter	Description	Default
1000	Disables all RTCM 3.0 messages	-

Parameter	Description	Default
1001	L1-only GPS RTK observables	0
1002	Extended L1-only GPS RTK observables	0
1003	L1 & L2 GPS RTK observables	0
1004	Extended L1 & L2 GPS RTK observables	1 s
1005	Stationary RTK reference station ARP	0
1006	Stationary RTK reference station ARP with antenna height	13 s
1007	Antenna descriptor	0
1008	Antenna descriptor & serial number	0
1009	L1-only GLONASS RTK observables	0
1010	Extended L1-only GLONASS RTK observables	0
1011	L1 & L2 GLONASS RTK observables	0
1012	Extended L1 & L2 GLONASS RTK observables	1 s
1013	System parameter	0
1019	GPS ephemeris data	0
1020	GLONASS ephemeris data	0
1029	Unicode text string	0
1033	Receiver and antenna descriptors	31 s

Examples

Setting RTCM message types 18 and 19 (output rate: 1 s):

\$PASHS,RTC,TYP,18,1

Disabling all RTCM 3.x messages:

\$PASHS,RTC,TYP,1000*6C

Comments

- RTCM2.3 and RTCM 3.x messages can coexist. The \$PASHS,BAS command will finally determine which of the existing messages should be broadcast.
- \$PASHS,RTC,TYP,0 will disable all enabled RTCM2.3 messages.
- \$PASHS,RTC,TYP,1000 will disable all enabled RTCM3.x messages.

Relevant Query Command

\$PASHQ,RTC,MSI

See also

\$PASHS,BAS

\$PASHS,CPD,MOD,BAS

SBA: Enabling/Disabling SBAS Tracking

Function This command is used to enable or disable SBAS tracking.

Command Format **Syntax**

\$PASHS,SBA,s1[*cc]

Parameters

Parameter	Description	Range	Default
s1	Enables (ON) or disables (OFF) SBAS tracking	ON, OFF	ON
*cc	Optional checksum	*00-*FF	

Example

Enabling SBAS tracking:

\$PASHS,SBA,ON*08

Relevant Query Command \$PASHQ,SBA

See also \$PASHS,GLO

SIT: Defining a Site Name

Function This command is used to define a site name that will be used in the naming of the next logged raw data file.

Command Format **Syntax**

\$PASHS,SIT,s[*cc]

Parameters

Parameter	Description	Range
s	Site name (or site ID), a 4-character string where "*", ".", "/" and "\" are not allowed.	
*cc	Optional checksum	*00-*FF

Example

Defining site name "ECC1":

`$PASHS,SIT,ECC1*63`

Relevant Query Command `$PASHQ,SIT`

See also `$PASHS,REC`

SNM: Signal-To-Noise Ratio Mask

Function This command is used to mask the signal observations that do not meet the minimum C/A code signal-to-noise ratio you specify. This means that only the observations meeting this requirement will be used in the PVT computation (all the others will be rejected).

Command Format Syntax
`$PASHS,SNM,d1[*cc]`

Parameters

Parameter	Description	Range	Default
d1	SNR mask, in dB.Hz	0-60	0
*cc	Optional checksum	*00-*FF	

Example

Setting the SNR mask to 45 dB.Hz:

```
$PASHS,SNM,45*08
```

Relevant Query Command `$PASHQ,SNM`

SOM: Masking Signal Observations

Function The SOM command is used to apply masks on the following data:

- Cumulative tracking time (CTT), in seconds
- Navigation data (NAV)
- Signal-to-Noise Ratio (SNR), in dBHz

- Channel warnings (WRN)

As a result of the presence of these masks, only the signal observations meeting the required level of quality will be made available by the receiver through the relevant output messages.

Command Format Syntax

`$PASHS,SOM,d[*cc]`

Parameters

Parameter	Description	Range	Default
d	Observation mask index	See table below.	4
*cc	Optional checksum	*00-*FF	

Observation mask Index	
d	Description
0	No masking
1	Reference station
2	Static base
3	Moving base
4	Rover (default)
9	User-defined

Comments

“Masking” signal observations therefore means definitively rejecting those observations not meeting the level of quality requested by the different masks set through the SOM command.

“SOM” stands for “Signal Observations Masks”.

Example

Setting masks for a reference station:

`$PASHS,SOM,1*39`

Relevant Query Command
`$PASHQ,PAR`
`$PASHQ,SOM`

See Also
`$PASHS,SOM,SNR`
`$PASHS,SOM,NAV`
`$PASHS,SOM,WRN`
`$PASHS,SOMM,CTT`

SOM,CTT: Cumulative Tracking Time Mask

Function This command is used to mask the signal observations that do not meet the minimum continuous tracking time you specify. This means that only the observations meeting this requirement will be output (all the others will be rejected). This mask is enabled only after the “User-defined” option (9) has been selected with the \$PASHS,SOM command.

Command Format Syntax

```
$PASHS,SOM,CTT,d1[,d2][*cc]
```

Parameters

Parameter	Description	Range	Default
d1	Minimum continuous tracking time for differential data, in seconds. “0” means no mask.	0-255	10
d2	Minimum continuous tracking time for raw data, in seconds. If d2 is omitted, then the receiver will assume d2=d1. “0” means no mask.	0-255	10
*cc	Optional checksum	*00-*FF	

Raw Data Masked by d2	Differential Data Masked by d1
MPC DPC ATM,MES ATM,RNX,SCN,0	All other messages

Comments

- “Continuous” tracking means tracking “without cycle slips”.
- This command can only mask some particular signal data. If however at the same time the L1CA data are disabled, then ALL the satellite observations, and not only the masked ones, will be rejected.
- This command equally affects all GNSS and their signals.

Examples

Setting CTT masks for differential and raw data to 20 s:

```
$PASHS,SOM,CTT,20*65
```

Enabling all signal observations to be output regardless of the continuous tracking time requirement (no CTT mask):

```
$PASHS,SOM,CTT,0*57
```

Relevant Query Command \$PASHQ,PAR
\$PASHQ,SOM,CTT

See Also \$PASHS,SOM
\$PASHS,SOM,SNR
\$PASHS,SOM,NAV
\$PASHS,SOMM,WRN

SOM,NAV: Navigation Data Mask

Function This command is used to mask the signal observations that are not consistent with the relevant navigation data. This means that only the observations meeting this requirement will be output (all the others will be rejected). This mask is enabled only after the “User-defined” option (9) has been selected with the \$PASHS,SOM command.

Command Format Syntax
\$PASHS,SOM,NAV,s1[,s2][*cc]

Parameters

Parameter	Description	Range	Default
s1	Differential data mask	ON, OFF	ON
s2	Raw data mask. If s2 is omitted, then the receiver will assume s2=s1	ON, OFF	OFF
*cc	Optional checksum	*00-*FF	

Raw Data Masked by s2	Differential Data Masked by s1
MPC DPC ATM,MES ATM,RNX,SCN,0	All other messages

Comments

- Stating that signal observations are consistent with the corresponding navigation data means the following:
 - GNSS time, receiver position and receiver clock offsets are available and valid.
 - L1CA pseudo-range for a given satellite is measured and valid.

- The corresponding satellite navigation data are available and valid.
- The L1CA pseudo-range and computed range are in agreement with each other.
- Elevation and azimuth angles are available and valid.

If at least one of the above requirements is not met, then signal observations are found to be not consistent with navigation data.

- The \$PASHS,SOM,NAV command will mask all signals (all observables) corresponding to a given satellite, even if some other pseudo-ranges (e.g. L2C) can be consistent with the navigation data.
- The \$PASHS,SOM,NAV command equally affects all GNSS systems.

Examples

Setting NAV masks for both differential and raw data:

```
$PASHS,SOM,NAV,ON*7C
```

Enabling all signal observations to be output regardless of whether they are consistent with navigation data or not (no NAV mask):

```
$PASHS,SOM,NAV,OFF*32
```

Relevant Query Command	\$PASHQ,PAR \$PASHQ,SOM,NAV
See Also	\$PASHS,SOM \$PASHS,SOM,SNR \$PASHS,SOM,CTT \$PASHS,SOM,WRN

SOM,SNR: Signal-to-Noise Ratio Mask

Function This command is used to mask the signal observations that do not meet the minimum signal-to-noise ratio you specify. This means that only the observations meeting this requirement will be output (all the others will be rejected). This mask is enabled only after the “User-defined” option (9) has been selected with the \$PASHS,SOM command.

Command Format Syntax

\$PASHS,SOM,SNR,f1[,f2][*cc]

Parameters

Parameter	Description	Range	Default
f1	Differential data mask. "0" means no mask.	0-60 dBHz	28
f2	Raw data mask. If s2 is omitted, then the receiver will assume s2=s1. "0" means no mask.	0-60 dBHz	28
*cc	Optional checksum	*00-*FF	

Raw Data Masked by f2	Differential Data Masked by f1
MPC DPC ATM,MES ATM,RNX,SCN,0	All other messages

Comments

- The \$PASHS,SOM,SNR command can only mask particular signal data for which the SNR does not meet your requirement. If however at the same time the L1CA data are disabled, then all the satellite observations will also be masked.
- The \$PASHS,SOM,SNR command equally affects all GNSS systems and their signals, except GPS L1P(Y) and L2P(Y). For these two signals, a hard-coded SNR threshold is applied.

Examples

Setting SNR masks for both differential and raw data to 30 dBHz:

\$PASHS,SOM,SNR,30*68

Enabling all signal observations to be output regardless of the signal-to-noise ratio:

\$PASHS,SOM,SNR,0*5B

Relevant Query Command \$PASHQ,PAR
\$PASHQ,SOM,SNR

See Also \$PASHS,SOM
\$PASHS,SOM,NAV
\$PASHS,SOM,CTT

\$PASHS,SOMM,WRN

SOM,WRN: Channel Warnings Mask

Function This command is used to mask the signal observations for those signals flagged with channel warnings (MPC warning bits are counted from 1 to 8). This means that only the observations from non-flagged signals will be output (all the others will be rejected).

This mask is enabled only after the “User-defined” option (9) has been selected with the \$PASHS,SOM command.

Command Format Syntax

\$PASHS,SOM,WRN,s1[,s2][*cc]

Parameters

Parameter	Description	Range	Default
s1	Differential data mask	ON, OFF	ON
s2	Raw data mask. If s2 is omitted, then the receiver will assume s2=s1	ON, OFF	OFF
*cc	Optional checksum	*00-*FF	

Raw Data Masked by s2	Differential Data Masked by s1
MPC DPC ATM,MES ATM,RNX,SCN,0	All other messages

Comments

- A signal is considered as flagged in at least one of the following cases:
 - Carrier phase tracking is not stable (Bit 3 of MPC/MCA warning is set).
 - Pseudo-range data quality is bad (Bit 5 of MPC/MCA warning is set).
 - Polarity is not resolved (MPC/MCA Phase Tracking Polarity flag is set to 0).
- The \$PASHS,SOM,WRN command will mask only some particular signal data (e.g. L1CA or L2P) corresponding to a given satellite. If at the same time the L1CA data are disabled, then ALL the satellite observations, and not only those masked, will be rejected.

- The \$PASHS,SOM,WRN command equally affects all GNSS systems.

Examples

Setting WRN masks for both differential and raw data:

```
$PASHS,SOM,WRN,ON*6E
```

Enabling all signal observations to be output regardless of whether some signals are flagged or not (no WRN mask):

```
$PASHS,SOM,WRN,OFF*20
```

Relevant Query Command \$PASHQ,PAR
\$PASHQ,SOM,WRN

See Also \$PASHS,SOM
\$PASHS,SOM,SNR
\$PASHS,SOM,CTT
\$PASHS,SOM,NAV

STI: Defining a Station ID

Function This command is used to define the station ID the base receiver will broadcast in its differential messages to the rover.

Command Format Syntax

```
$PASHS,STI,d[*cc]
```

Parameters

Parameter	Description	Range
d	Station ID	0-1023 (RTCM 2.3) 0-4095 (RTCM 3.x and ATOM) 0-31 (CMR & CMR+)
*cc	Optional checksum	*00.*FF

Examples

Defining station ID "150" for use in RTCM messages:

```
$PASHS,STI,150*23
```

Note

If the chosen station ID is beyond the upper limit in the applicable range, then the value “31” is chosen instead (i.e. “31” instead of “56” for example if CMR/CMR+ messages are broadcast, or “31” instead of “1041” for example if RTCM 2.3 messages are broadcast).

Relevant Query Command \$PASHQ,STI

See also \$PASHS,BAS
\$PASHS,MOD,BAS

SVM: Setting the Maximum Number of Observations in the PVT

Function: This function is used to set the maximum number of code and doppler observations used in the PVT calculation.

Command Format **Syntax**
\$PASHS,SVM,d1[*cc]

Parameters

Parameter	Description	Range	Default
d1	Maximum number of observations	0-26	14
*cc	Optional checksum	*00-*FF	-

Example

Setting the number of observations to 25:

\$PASHS,SVM,25*16

Comments This setting affects all the positioning modes, except for the time-tagged RTK mode for which this limit is hardware coded and set to 14 satellites.

Relevant Query Command \$PASHQ,SVM
\$PASHQ,PAR

UDP: User-Defined Dynamic Model Parameters

Function This command is used to set the upper limits of the dynamic model (velocity, acceleration).

Command Format **Syntax**
`$PASHS,UDP,f1,f2,f3,f4[*cc]`

Parameters

Parameter	Description	Range	Default
f1	Maximum expected horizontal velocity in m/s.	0-100 000	100 000
f2	Maximum expected horizontal acceleration in m/s/s.	0-100	100
f3	Maximum expected vertical velocity in m/s.	0-100 000	100 000
f4	Maximum expected vertical acceleration in m/s/s.	0-100	100
*cc	Optional checksum	*00-*FF	-

Example

Setting the dynamic model:

`$PASHS,UDP,10,1,2,0.5*1D`

Comments

The user-defined dynamic model is activated by the `$PASHS,DYN,9` command. Note that when the adaptive dynamic mode (`DYN,8`) is selected, the user-defined model is automatically excluded from the possible models that could best describe the current receiver dynamics.

Relevant Query Command `$PASHQ,UDP`

See Also `$PASHS,DYN`

UNT: Distance Unit Used on Display Screen

Function: This function is used to choose the distance unit you want the receiver to use when providing coordinates on its display screen.

Command Format Syntax`$PASHS,UNT,s1[*cc]`**Parameters**

Parameter	Description	Range	Default
s1	Desired distance unit: • M: Meters • F: US Survey Feet • IF: International Feet	M, F, IF	M
*cc	Optional checksum	*00-*FF	-

Example

Choosing US Survey Feet:

`$PASHS,UNT,F*50`

Relevant Query Command `$PASHQ,UNT`

UTS: Synchronizing Onto GPS Time

Function: This function is used to enable or disable a clock steering mechanism that synchronizes measurements and coordinates with the GPS system time rather than with the local (receiver) clock.

Command Format Syntax`$PASHS,UTS,s1[*cc]`**Parameters**

Parameter	Description	Range	Default
s1	Enabling (ON) or disabling (OFF) synchronization with GPS time	ON, OFF	ON
*cc	Optional checksum	*00-*FF	-

Example

Enabling synchronization:

`$PASHS,UTS,ON*0A`

- Comments**
- All output data, except for legacy MPC, DPC and RPC, are always clock steered.
 - Legacy MPC, DPC and RPC data appear as steered or not steered depending on the last \$PASHS,UTS command run.
 - The PBN message contains internal clock and clock drift estimates when UTS is OFF and reports zeros for these estimates when UTS is ON.
 - The ATOM,RNX message with scenario 0 contains original clock and clock drift estimates that can be used on decoding side to restore the original (not steered) observables, if needed.

Relevant Query \$PASHQ,UTS
Command \$PASHQ,PAR

WAK: Acknowledging Alarms

Function This command is used to acknowledge all alarms. This will also turn off the beeper (if previously set to beep on occurrence of an alarm). After sending the command, all alarms will switch from the “current” to the acknowledged (“pending”) status.

Command Format **Syntax**
 \$PASHS,WAK[*cc]

Parameters

None.

Example

Acknowledging all alarms:

\$PASHS,WAK*28

Relevant Query \$PASHQ,WARN
Command

ZDA: Setting Date & Time

Function This command is used to set the date and time in the receiver.

Command Format Syntax
\$PASHS,ZDA,m1,d2,d3,d4[*cc]

Parameters

Parameter	Description	Range
m1	UTC time (hhmmss.ss)	000000.00-235959.99
d2	Current day	01-31
d3	Current month	01-12
d4	Current year	0000-9999
*cc	Optional checksum	*00-*FF

Example

\$PASHS,ZDA,151145.00,13,03,2008*0A

Relevant Query Command \$PASHQ,ZDA

See also \$PASHS,LTZ

Appendix C. Query Command Library

AGB: Reading GLONASS Bias Setting

Function This command tells you whether L1 & L2 GLONASS carrier biases are currently processed in the receiver or not.

Command Format **Syntax**
\$PASHQ,AGB[*cc]

Parameters
None.

Response Format **Syntax**
\$PASHR,AGB,s1*cc

Parameters

Parameter	Description	Range
s1	ON: Processing enabled OFF: Processing disabled	ON, OFF
*cc	Checksum	*00-*FF

Example
\$PASHQ,AGB*33
\$PASHR,AGB,ON*1D

Relevant Set Command \$PASHS,AGB

ALM: Almanac Message

Function This command allows you to output the latest GPS almanac data. Each response line describes the almanac data from a given GPS satellite.

Command Format Syntax
\$PASHQ,ALM[*cc]

Response Format Syntax
\$GPALM,d1,d2,d3,d4,h5,h6,h7,h8,h9,h10,h11,h12,h13,h14,h15*cc

Parameters

Parameter	Description	Range
d1	Total number of messages	01-32
d2	Number of this message	01-32
d3	Satellite PRN number	01-32
d4	GPS week	4 digits
h5	SV health (in ASCII hex)	2 bytes
h6	e: Excentricity (in ASCII hex)	4 bytes
h7	toe: Almanac reference time, in seconds (ASCII hex)	2 bytes
h8	lo: Inclination angle, in semicircles (ASCII hex)	4 bytes
h9	OMEGADOT: Rate of ascension, in semicircles/second (ASCII hex)	4 bytes
h10	A1/2: Square root of semi-major axis, in meters 1/2 (ASCII hex)	6 bytes
h11	OMEGA: Argument of perigee, in semicircles (ASCII hex)	6 bytes
h12	OMEGA0: Longitude of ascension mode, in semicircles (ASCII hex)	6 bytes
h13	Mo: Mean anomaly, in semi-circles (ASCII hex)	6 bytes
h14	af0: Clock parameter, in seconds (ASCII hex)	3 bytes
h15	af1: Clock parameter, in seconds/second (ASCII hex)	3 bytes
*cc	Checksum	*00-*FF

Example

```
$PASHQ,ALM
$GPALM,31,1,01,65535,00,39A8,4E,1FEA,FD65,A10C8C,B777FE,935A86,C
994BE,0C6,001*73
$GPALM,31,2,02,65535,00,4830,4E,00D9,FD49,A10D24,64A66D,3B6857,E
6F2A3,0BA,001*7A
$GPALM,31,3,03,65535,00,552B,4E,F572,FD3B,A10CE1,20E624,0CD7E1,D
10C32,0CA,001*0D
```

```
$GPALM,31,4,04,65535,00,4298,4E,0069,FD46,A10D5C,0EE3DC,3C2E3E,5
1DDF9,FF0,FFF*0A
```

...

Automatic Output of ALM Messages

This is a reminder on how to output ALM messages at regular intervals of time: Use the \$PASHS,NME command with the syntax below:

```
$PASHS,NME,ALM,<port_ID>,ON,<Rate>
```

For more details on the \$PASHS,NME command, refer to the *Set Command Library* Chapter.

As an example, the command below will output ALM messages on port A at a rate of 15 seconds:

```
$PASHS,NME,ALM,A,ON,15
```

ANH: Antenna Height

Function This command allows you to read the entered antenna height as well as the measurement type used.

Command Format **Syntax**

```
$PASHQ,ANH[*cc]
```

Response Format **Syntax**

```
$PASHR,ANH,f1,c2*cc
```

Parameters

Parameter	Description	Range
f1	Antenna height.	0-6.553 m
c2	Antenna height measurement type: <ul style="list-style-type: none"> • V: Vertical measurement • S: Slant measurement 	V, S
*cc	Checksum	*00-*FF

Example

```
$PASHQ,ANH
$PASHR,ANH,1.568,S*44 (slant measurement, H=1.568 m)
```

Relevant Set Command \$PASHS,ANH

See also \$PASHQ,ANR

ANP: Antenna Parameters

Function This command allows you to read the antenna parameters of the specified antenna name, or of the complete antenna database if no antenna name is specified.

Command Format Syntax

```
$PASHQ,ANP[*cc]
or
$PASHQ,ANP,s1[*cc]
```

Parameters

Parameter	Description	Range
s1	Antenna name (case sensitive)	31 characters max.
*cc	Optional checksum	*00-*FF

Response Formats (Through examples)

```
$PASHQ,ANP
LIST OF PREDEFINED ANTENNAS (d1):
ANT1          ANT2
ANT3          ANT4
...
LIST OF USERDEFINED ANTENNAS (d2):
ANT10         ANT11
ANT12         ANT13
...
OWN ANTENNA: ASH802147
REFERENCE ANTENNA: UNKNOWN
OUT ANTENNA: NULLANTENNA
RECEIVED ANTENNA: ASH802147
```

(Where d1 is the number of predefined antennas and d2 is the number of user-defined antennas.)

```
$PASHQ,ANP,ASH802147
ASH802147
L1 N:+000.30 E:+002.20 U:+104.00
L1 PAE:+000.0+000.9+001.9+003.1+004.4+005.5+006.4+007.2+007.6
+007.7
+007.4+006.7+005.5+004.1+002.2+000.0-002.3+000.0+000.0
L2 N:-002.10 E:-001.00 U:+100.10
L2 PAE:+000.0-000.3+000.0+000.6+001.5+002.4+003.2+003.9+004.3
+004.4
+004.2+003.5+002.5+001.1-000.7-002.8-005.1+000.0+000.0
```

Relevant Set \$PASHS,ANP,OWN
Commands \$PASHS,ANP,REF
 \$PASHS,ANP,PCO

ANP,OUT: Virtual Antenna

Function This command returns the name of the virtual antenna currently selected in the receiver.

Command Format **Syntax**
 \$PASHQ,ANP,OUT[*cc]

Parameters
 None.

Response Format **Syntax**
 \$PASHR,ANP,OUT,s1*cc

Parameters

Parameter	Description	Range
s1	Name of the virtual antenna. If "OFF" is returned, this means no virtual antenna is selected.	31 characters max.
*cc	Checksum	*00-*FF

Example \$PASHQ,ANP,OUT
 \$PASHR,ANP,OUT,ADVNULLANTENNA*72

Relevant Set \$PASHS,ANP,OUT
Command

ANP,OWN: Local Antenna Used

Function This command returns the name of the GNSS antenna currently used by the receiver.

Command Format **Syntax**
 \$PASHQ,ANP,OWN[*cc]

Parameters

None.

Response Format Syntax

\$PASHR,ANP,OWN,s1,s2,s3*cc

Parameters

Parameter	Description	Range
s1	Name of the local antenna	31 characters max.
s2	Antenna serial number	31 characters max.
	Antenna setup ID	0-255
*cc	Checksum	*00-*FF

Example

\$PASHQ,ANP,OWN
 \$PASHR,ANP,OWN,ASH802147,201143125*30

Relevant Set Command \$PASHS,ANP,OWN

ANP,RCV: Antenna Name and Offsets of Received Base

Function This command queries the receiver for the antenna name and offsets of the received base.

Command Format Syntax

\$PASHQ,ANP,RCV[*cc]

Response Format Syntax

\$PASHR,ANP,RCV,s1,f2,f3,f4,f5,f6,f7*cc

Parameters

Parameter	Description
s1	Antenna name, "NONE" if non name received for the base antenna.
f2	L1 North offset, in mm
f3	L1 East offset, in mm
f4	L1 Up offset, in mm
f5	L2 North offset, in mm
f6	L2 East offset, in mm
f7	L2 Up offset, in mm
*cc	Checksum

Example \$PASHQ,ANP,RCV

\$PASHR,ANP,RCV,ASH802147,-2.00,0.70,103.00,-3.4,-2.2,103.80*09

ANP,REF: Antenna Used at the Base

Function This command returns the name of the GNSS antenna assumed to be used by the base currently sending data to the interrogated receiver (a rover).

Command Format Syntax
\$PASHQ,ANP,REF[*cc]

Parameters

None.

Response Format Syntax
\$PASHR,ANP,REF,s1,d2*cc

Parameters

Parameter	Description	Range
s1	Name of the antenna used at the base	31 characters max.
d2	Antenna name preference: <ul style="list-style-type: none"> • 0: s1 is ignored if incoming reference data include base antenna name • 1: s1 is always used; decoded base antenna name is ignored 	0, 1
*cc	Checksum	*00-*FF

Example
\$PASHQ,ANP,REF
\$PASHR,ANP,REF,ASH111661,1*3D

Relevant Set Command **\$PASHS,ANP,REF**

ANR: Antenna Reduction Mode

Function This command is used to read the current setting for the antenna reduction mode. This setting defines the physical location on the system for which the position is computed.

Command Format Syntax
 \$PASHQ,ANR[*cc]

Response Format Syntax
 \$PASHR,ANR,s1*cc

Parameters

Parameter	Description	Range
s1	Antenna reduction mode: <ul style="list-style-type: none"> • OFF: The computed position is assumed to be the location of the antenna's L1 phase center. • ON: The computed position is assumed to be the location of the ground mark. • ARP: The computed position is assumed to be the location of the Antenna Reference Plane (ARP). 	OFF, ON, ARP
*cc	Checksum	*00-*FF

Example
 \$PASHQ,ANR
 \$PASHR,ANR,ON*04

Relevant Set Command \$PASHS,ANR

See also \$PASHS,ANH

ANT: Antenna Height

Function This command is used to read the current setting for the antenna height.

Command Format Syntax
 \$PASHQ,ANT[*cc]

Response Format Syntax
 \$PASHR,ANT,f1,f2,f3,m4,f5*cc

Parameters

Parameter	Description	Range
f1	Slant height measurement, from ground mark to antenna edge (SHMP)	0-6.553 m
f2	Antenna radius: horizontal distance from the geometrical center to the antenna edge.	0-6.553 m
f3	Antenna vertical offset: <ul style="list-style-type: none"> Offset between SHMP and ARP if both slant height measurement and antenna radius are different from zero. Offset between ground mark and ARP if either slant height measurement or radius is zero. 	± 0-6.553 m
m4	Horizontal azimuth [dddmm.mm], in degrees, for the horizontal line connecting the ground mark to the surveyed point, measured with respect to the Geographical North. Currently NOT processed.	0-35959.99
f5	Horizontal offset from the ground mark to the surveyed point. Currently NOT processed.	0-6.553 m
*cc	Checksum	*00.*FF

Example

```
$PASHQ,ANT
$PASHR,ANT,0,0,2.000,0,0*49      (vertical, 2.000 m)
```

Relevant Set Command

```
$PASHS,ANT
```

See also

```
$PASHQ,ANR
$PASHQ,ANH
```

ATL: Debug Data Recording

Function

This command queries the receiver for the current status of the data recording function used for debugging.

Command Format

Syntax

```
$PASHQ,ATL[*cc]
```

Response Format

Syntax

```
$PASHR,ATL,s1,d2,c3,f4,d5*cc
```

Parameters

Parameter	Description	Range
s1	ON/OFF/AUT status: <ul style="list-style-type: none"> • ON: Debug data recording is enabled but will not re-start after a power cycle. • OFF: Debug data recording is disabled. • AUT: Debug data recording is enabled and will re-start after a power cycle. 	ON, OFF, AUT
d2	Indicates which data are recorded: <ul style="list-style-type: none"> • 0: Only data from GNSS board to system board are recorded. • 1: Only data from system board to GNSS board are recorded. • 2: Data flowing in both directions are recorded. 	0-2
c3	Recording status: <ul style="list-style-type: none"> • R: The receiver is currently recording data for debugging. • S: No debug data currently recorded. 	R, S
f4	Output rate, in seconds (default: 1 sec.)	0.05, 0.1, 0.2, 0.5, 1
d5	Configuration index	0, 1
*cc	Checksum	*00-*FF

Examples

Data recording disabled:

```
$PASHQ,ATL*2E
$PASHR,ATL,OFF,0,S,1,0*2C
```

Data recording enabled and in progress:

```
$PASHQ,ATL*2E
$PASHR,ATL,ON,0,R,0.5,0*79
```

Data recording is enabled but for some reason (no SD card, etc.), no data is being recorded:

```
$PASHQ,ATL*2E
$PASHR,ATL,ON,0,S,0.5,0*78
```

ATM: ATOM Data Parameters

Function This command allows you to read the current settings of the ATOM data-related parameters.

Command Format Syntax
\$PASHQ,ATM[*cc]

Response format Syntax
 (Through an example)
\$PASHQ,ATM

```

PER:001.00 ELM:5
DRI:001.00 SIT:2007 REC:N MEM:M
ANH:02.132 ANT:VERT ANR:ON
ATOM: MES PVT ATR NAV DAT EVT BAUD
PRTA: OFF OFF OFF OFF OFF OFF 7
PRTC: OFF OFF OFF OFF OFF OFF 1
PRTE: OFF OFF OFF OFF OFF OFF 1
MEMM: OFF OFF OFF OFF OFF OFF 1
MEMU: OFF OFF OFF OFF OFF OFF 0
  
```

Parameters

Parameter	Description	Range
PER	ATOM output rate	0.00-999.0 s
ELM	Elevation mask used in data recording & data output	0-90
DRI	Recording rate	0.00-999.0 s
SIT	Site ID	4 characters
REC	Data recording: <ul style="list-style-type: none"> • Y: Data recording enabled • N: Data recording disabled • S: Data recording enabled but stopped 	Y, N, S
MEM	Selected memory: <ul style="list-style-type: none"> • M: Internal memory • U: USB memory 	M, U
ANH	Antenna height	0.000-99.999
ANT	Height measurement type (slant/vertical)	SLANT, VERT
ANR	Antenna reduction mode	ON, OFF, ARP
PRTA		ON, OFF
PRTC	Label for Bluetooth	ON, OFF
PRTE	Label for Modem	ON, OFF
MEMM		
MEMU	Labels for memories	ON, OFF

Parameter	Description	Range
BAUD	If serial port used, then baud rate If memory used, "0" if not available, else "1"	0-15 (see table below)

Code	Baud Rate	Code	Baud Rate
0	300	8	57600
1	600	9	115200
2	1200	10	230400
3	2400	11	480600
4	4800	12	921600
5	9600	13	1428571
6	19200	14	2500000
7	38400	15	5000000

Relevant Set Command \$PASHS,ATM

See also \$PASHQ,ATM
\$PASHQ,ATO

ATO: ATOM Message Output Settings

Function This command allows you to read the different parameters of the ATOM message, as currently set on the specified port or memory. The receiver will return the response on the port through which the query command is sent.

Command Format Syntax
\$PASHQ,ATO,c[*cc]

Parameters

Parameter	Description	Range
c	Port ID for which you need to know the ATOM message settings: <ul style="list-style-type: none"> A: Serial port C: Bluetooth port E: Modem M: Internal memory U: External memory (USB) 	A, C, E, M, R, U
*cc	Optional checksum	*00-*FF

Response Format

Syntax

```
$PASHR,ATO,c1,d2,f3,d4,7(s5,f6)*cc
```

Parameters

Parameter	Description	Range
c1	The port ID mentioned in the query command is replicated in this field.	A, C, E, M, R, U
d2	Baud rate code, 0 if not available	0-15
f3	PER setting	0-999.0
d4	Number of ATOM messages	7
s5	ATOM message type	MES, PVT, ATR, NAV, DAT, EVT, RNX
f6	Output rate (0 if message disabled)	0-999.0
*cc	Checksum	*00-*FF

Example

Querying ATOM message parameters as currently set on port A:

```
$PASHQ,ATO,A
$PASHR,ATO,A,7,001.00,6,MES,0.00,PVT,0.00,ATR,0.00,NAV,0.00,DAT,
0.00,EVT,0.00,RNX,0.00*2A
```

See also

```
$PASHS,ATM
$PASHQ,ATM
```

BAS: Differential Data Type

Function

This command is used to list the message types generated and sent by a base.

Command Format

Syntax

```
$PASHQ,BAS[*cc]
```

Response Format Syntax

\$PASHR,BAS,c1,s2[,c3,s4]*cc

Parameters

Parameter	Description	Range
c1	First port ID: <ul style="list-style-type: none"> • A: Serial port • C: Bluetooth port • E: Modem • M, U: Memory • N: Undefined port 	A, C, E, M, N, U
s2	Differential data type: <ul style="list-style-type: none"> • RT2: RTCM 2.3 messages • RT3: RTCM 3.0 & 3.1 messages (default) • CMR: CMR messages • CMP: CMR+ messages • ATM: ATOM messages • DBN: DBEN messages • NONE: Undefined 	RT2, RT3, CMR, CMP, ATM, DBN, NONE
c3	Second port ID: same as c1 above	A, C, E, M, U
s4	Differential data type: same as s2 above.	RT2, RT3, CMR, CMP, ATM, DBN, NONE
*cc	Checksum	*00-*FF

Examples

The response line below reports RTCM 3.x messages sent on port A:

```
$PASHQ,BAS
$PASHR,BAS,A,RT3*50
```

The response line below reports RTCM 2.3 messages sent on port A and CMR+ messages on port E:

```
$PASHQ,BAS
$PASHR,BAS,A,RT2,E,CMP*4A
```

Relevant Set Command

```
$PASHS,BAS
```

See also

```
$PASHQ,CPD,MOD
$PASHQ,RTC
$PASHQ,ATD,MSI
$PASHQ,CMR,MSI
$PASHQ,RTC,MSI
```

BEEP: Beeper State

Function This command is used to read the current state of the internal beeper.

Command Format Syntax
 \$PASHQ,BEEP[*cc]

Response Format Syntax
 \$PASHR,BEEP,s1,d2*cc

Parameters

Parameter	Description	Range
s1	Beeper enabled (ON) or disabled (OFF)	ON, OFF
d2	Timeout, in seconds: <ul style="list-style-type: none"> • =0: No timeout • >0: Buzzer will go out after the specified timeout if the alarm has not been acknowledged at the end of that time. 	0-99
*cc	Checksum	*00-*FF

Example
 \$PASHQ,BEEP
 \$PASHR,BEEP,OFF*05

Relevant Set Command
 \$PASHS,BEEP

BRD: RTC Bridge

Function This command allows you to list the current settings of the RTC Bridge function.

Command Format Syntax
\$PASHQ,BRD[*cc]

Response format Syntax
\$PASHR,BRD,s1,d2,c3,c4*cc

Parameters

Parameter	Description	Range
s1	Availability of RTK corrections on the specified output port: <ul style="list-style-type: none"> • OFF: No RTK corrections forwarded to the output port. • ON: RTK corrections forwarded to the output port. 	ON, OFF
d2	Use of RTK corrections in the receiver's position computation. <ul style="list-style-type: none"> • 0: RTK corrections used • 1: RTK corrections not used 	0, 1
c3	Input port ID (port from which RTK corrections are available in the receiver).	E (modem)
c4	Output port ID (serial port to which the licence-free radio transmitter is connected).	A
*cc	Checksum	*00-*FF

Example

```
$PASHQ,BRD
$PASHR,BRD,ON,0,E,A*15
```

Relevant Set Command \$PASHS,BRD

BTH: Bluetooth Settings

Function This command is used to read the current Bluetooth settings.

Command Format Syntax
\$PASHQ,BTH[*cc]

Response Format Syntax

\$PASHR,BTH,s1,s2,d3*cc

Parameters

Parameter	Description	Range
s1	Bluetooth address (xx:xx:xx:xx:xx:xx)	17 characters
s2	Bluetooth name	64 characters max.
d3	Bluetooth PIN code	0 to 16 digits max. -1: no PIN code
*cc	Checksum	*00-*FF

Example

\$PASHQ,BTH

\$PASHR,BTH,00:07:80:83:91:86,PM_743109,-1*68

See also

\$PASHS,BTH,NAME

\$PASHS,BTH,PIN

CFG: GNSS Tracking Configuration

Function

This command queries the receiver for the type of GNSS tracking currently enabled.

Command Format Syntax

\$PASHQ,CFG[*cc]

Response Format Syntax

\$PASHR,CFG,s1*cc

Parameters

Parameter	Description	Range
s1	GNSS tracking currently enabled: <ul style="list-style-type: none"> • SSL: Single-signal tracking • DSL: Dual-signal tracking • TSL: Triple-signal tracking 	SSL, DSL, TSL
*cc	Checksum	

Example

\$PASHQ,CFG

\$PASHR,CFG,DSL*1D

See Also

\$PASHS,CFG

CMR,MSI: CMR Message Status

Function This command is used in a base receiver to read the current settings of the CMR messages the base currently generates and outputs.

Command Format Syntax
\$PASHQ,CMR,MSI[*cc]

Response Format Syntax
\$PASHR,CMR,MSI,d1,d2,d3,d4,d5,d6,d7,d8,d9*cc

Parameters

Parameter	Description	Range
d1	Number of CMR messages currently output	4
d2	Message type "0" label	0
d3	Message type "0" output rate, in seconds	0-300
d4	Message type "1" label	1
d5	Message type "1" output rate, in seconds	0-300
d6	Message type "2" label	2
d7	Message type "2" output rate, in seconds	0-300
d8	Message type "3" label	3
d9	Message type "3" output rate, in seconds	0-300
*cc	Checksum	*00-*FF

Example The response line below reports four enabled CMR messages, type "0" and "3" at 1 second, and types "1" and "2" at 30 seconds:

```
$PASHQ,CMR,MSI
$PASHR,CMR,MSI,4,0,1,0,1,30,0,2,30,0,3,1,0*50
```

See also \$PASHS,CMR,TYP
 \$PASHQ,BAS
 \$PASHQ,CPD,MOD

CPD,AFP: Ambiguity Fixing Parameter

Function This command is used to read the current setting for the ambiguity fixing parameter.

Command Format Syntax
 \$PASHQ,CPD,AFP[*cc]

Response Format Syntax
 \$PASHR,CPD,AFP,*cc

Parameters

Parameter	Description	Range
f	Ambiguity fixing value. "0" means the receiver will stay in Float mode.	0, 95.0, 99.0, 99.9
*cc	Checksum	*00-*FF

Example \$PASHQ,CPD,AFP
 \$PASHR,CPD,AFP,99.0*6A

See also \$PASHS,CPD,AFP

CPD,ANT: Base Antenna Height

Function This command is used to read the current parameters of the base antenna height, as received by the rover.

Command Format Syntax
\$PASHQ,CPD,ANT[*cc]

Response Format Syntax
\$PASHR,CPD,ANT,f1,f2,f3,m4,f5*cc

Parameters

Parameter	Description	Range
f1	Antenna height, in meters	0-99.999
f2	Antenna radius, in meters	0-9.9999
f3	Vertical offset, in meters	0-99.999
m4	Horizontal azimuth, in degrees, minutes (dddmm.mm)	0-35959.99
f5	Horizontal distance, in meters	0-99.999
*cc	Checksum	*00-*FF

Example **\$PASHQ,CPD,ANT**
\$PASHR,CPD,ANT,1.893,0.0980,0.040,0.0000,0.000*50

See also \$PASHS,ANH
 \$PASHS,ANR
 \$PASHQ,CPD,POS

CPD,FST: Fast RTK Output Mode

Function This command is used to read the current setting for fast RTK output mode.

Command Format Syntax
\$PASHQ,CPD,FST[*cc]

Response Format Syntax
\$PASHR,CPD,FST,s*cc

Parameters

Parameter	Description	Range
s	Fast RTK mode (fast CPD)	ON, OFF
*cc	Checksum	*00-*FF

Example
\$PASHQ,CPD,FST
\$PASHR,CPD,FST,ON*63

Relevant Set Command \$PASHS,CPD,FST

See also \$PASHQ,CPD

CPD,MOD: Base/Rover/Backup Mode

Function This command is used to query the operating mode of the receiver, and the satellite constellations used if the receiver is operated as a base.

Command Format Syntax
\$PASHQ,CPD,MOD[*cc]

Response Format Syntax
\$PASHR,CPD,MOD,s1,d2,d3,c4*cc

Parameters

Parameter	Description	Range
s1	Current operating mode: <ul style="list-style-type: none"> • BAS: Base • ROV: Rover • BKP: "Hot Standby RTK", also called "Backup mode" (rover computing two RTK positions) 	BAS, ROV, BKP
d2	Constellations currently used if the receiver is defined as a base: <ul style="list-style-type: none"> • 0: GPS, GLONASS, SBAS (default mode) • 1: Only GPS and SBAS • 2: Only GPS and GLONASS • 3: Only GPS 	0-3
d3	Position mode. If BAS is the selected operating mode: <ul style="list-style-type: none"> • 0: Static position • 1: Moving position If ROV is the selected operating mode: <ul style="list-style-type: none"> • 0: means rover works with a static base • 1: means rover works with a moving base 	0-1
c4	Input port for backup mode: <ul style="list-style-type: none"> • A: Serial port • C: Bluetooth port • D: Radio • E: Modem 	A, C, D, E
*cc	Checksum	*00-*FF

Example

The response line below indicates that the receiver is configured as a base, uses the GPS and GLONASS constellations, and the base has a static position:

```
$PASHQ,CPD,MOD
$PASHR,CPD,MOD,BAS,2,0,A*5A
```

Relevant Set Command \$PASHS,CPD,MOD

See also \$PASHQ,CPD

CPD,NET: RTK Network Operation Mode

Function This command is used to read the current setting of the RTK network operation mode.

Command Format Syntax
\$PASHQ,CPD,NET[*cc]

Response Format Syntax
\$PASHR,CPD,NET,d1,d2*cc

Parameters

Parameter	Description	Range
d1	RTK network operating mode relative to GPS corrections: <ul style="list-style-type: none"> • 0: GPS corrections from network are not used. • 1: FKP/MAC GPS corrections from network are used when available and healthy, otherwise they are rejected. 	0-1
d2	RTK network operating mode relative to GLONASS corrections: <ul style="list-style-type: none"> • 0: GLONASS corrections from network are not used. • 1: FKP/MAC GLONASS corrections from network are used when available and healthy, otherwise they are rejected. 	0-1
*cc	Checksum	*00-*FF

Example

```
$PASHQ,CPD,NET
$PASHR,CPD,NET,1,0*51
```

The response line reports that the receiver will process network corrections, if available and healthy.

Relevant Set Command \$PASHS,CPD,NET

See also \$PASHQ,CPD

CPD,POS: Base Position

Function

If applied to a base, this command allows you to read the geographic coordinates previously entered for the base position.

Depending on the last \$PASHS,ANR command applied to the base, the position you get will be either that of the phase center, the ARP or the ground mark.

If applied to a rover, this command allows you to read the position of the base the rover receives from the base. The coordinates will all be "0" if the rover does not receive the base position.

Command Format Syntax

\$PASHQ,CPD,POS[*cc]

Response Format Syntax

\$PASHR,CPD,POS,m1,c2,m3,c4,f5*cc

Parameters

Parameter	Description	Range
m1	Latitude in degrees and minutes with 7 decimal places (ddmm.mmmmmmm)	0-90
c2	North (N) or South (S)	N, S
m3	Longitude in degrees, minutes with 7 decimal places (ddmm.mmmmmmm)	0-180
c4	West (W) or East (E)	W, E
f5	Height in meters	±9999.9999
*cc	Checksum	*00-*FF

Examples

\$PASHQ,CPD,POS

\$PASHR,CPD,POS,4717.959483,N,00130.500968,W,70.229*59

\$PASHQ,CPD,POS

\$PASHR,CPD,POS,0000.000000,N,00000.000000,E,00.000*7A

See also \$PASHS,POS

\$PASHQ,CPD,ANT

\$PASHQ,ANR

\$PASHQ,ANH

CPD,REM: Differential Data Port

Function This command allows you to read the port IDs that route differential data to a rover as well as the port selection mode.

Command Format Syntax
\$PASHQ,CPD,REM[*cc]

Response Format Syntax
\$PASHR,CPD,REM,s1[,c2][,c3]*cc

Parameters

Parameter	Description	Range
s1	Reception mode: <ul style="list-style-type: none"> • AUT: Automatic (default) • MAN: Manual 	AUT, MAN
c2	Input port #1: <ul style="list-style-type: none"> • A: Serial port • C: Bluetooth port • D: Radio • E: Modem 	A, C, D, E
c3	Input port #2: <ul style="list-style-type: none"> • A: Serial port • C: Bluetooth port • D: Radio • E: Modem 	A, C, D, E
*cc	Checksum	*00-*FF

Examples

(Automatic selection of the input port:)

```
$PASHQ,CPD,REM  

$PASHR,CPD,REM,AUT*39
```

(Manual selection, port D (radio) expected to receive the data:)

```
$PASHQ,CPD,REM  

$PASHR,CPD,REM,MAN,D*53
```

(Manual selection, ports D and E (radio + GSM) expected to receive the data:)

```
$PASHQ,CPD,REM  

$PASHR,CPD,REM,MAN,D,E*3A
```

Relevant Set Command **\$PASHS,CPD,REM**

See also \$PASHQ,CPD,MOD

CPD,VRS: VRS Assumption Mode

Function This command allows you to read the current setting of the VRS assumption mode.

Command Format Syntax
\$PASHQ,CPD,VRS[*cc]

Response format Syntax
\$PASHR,CPD,VRS,d*cc

Parameters

Parameter	Description	Range
d	VRS assumption mode: <ul style="list-style-type: none"> • 0: Automatic detection • 1: Compulsory VRS mode • 2: Never switches to VRS mode 	0-2
*cc	Optional checksum	*00-*FF

Example

```
$PASHQ,CPD,VRS
$PASHR,CPD,VRS,1*45
```

Relevant Set Command \$PASHS,CPD,VRS

CRT: Cartesian Coordinates of Position

Function This command allows you to get the message containing the absolute ECEF coordinates of the last computed position as well as other information on the position solution.

Command Format Syntax
\$PASHQ,CRT[*cc]

Response Format Syntax
\$PASHR,CRT,d1,d2,m3,f4,f5,f6,f7,f8,f9,f10,f11,f12,f13,f14,f15,s16*cc

Parameters

Parameter	Description	Range
d1	Position mode: <ul style="list-style-type: none"> • 0: Autonomous • 1: RTCM (or SBAS differential) • 2: RTK float • 3: RTK fixed • 9: SBAS Differential. See comment. 	0-3, 9
d2	Count of SVs used in position computation	3-27
m3	UTC time (hhmmss.ss)	000000.00-235959.99
f4	ECEF X coordinate, in meters	±9999999.999
f5	ECEF Y coordinate, in meters	±9999999.999
f6	ECEF Z coordinate, in meters	±9999999.999
f7	Receiver clock offset, in meters	±300000
f8	Velocity vector, X component, in m/s	±9.999
f9	Velocity vector, Y component, in m/s	±9.999
f10	Velocity vector, Z component, in m/s	±9.999
f11	Receiver clock drift, in m/s	± 2000
f12	PDOP	0.0-99.9
f13	HDOP	0.0-99.9
f14	VDOP	0.0-99.9
f15	TDOP	0.0-99.9
s16	Firmware version ID (GNSS board fw)	4-char string
*cc	Checksum	*00-FF

Example

```
$PASHQ,CRT
$PASHR,CRT,3,07,130452.50,4331844.177,-114063.156,4664458.677,
-0.023,-0.002,0.002,0.001,-0.023,2.1,1.2,1.7,1.3,G010*6C
```

Comment

The code allotted to a position solution of the SBAS differential type is either “1” or “9”, depending on the last \$PASHS,NPT command run.

See also \$PASHS,NME
\$PASHS,NPT

CTS: Handshaking

Function This command allows you to query the handshaking (RTS/CTS) protocol status for port A. If no port is specified in the command, the response message is sent back to the port that issued the query command.

Command Format Syntax
\$PASHQ,CTS[s1][*cc]

Response Format Syntax
\$PASHR,CTS,s2*cc

Parameters

Parameter	Description	Range
s1	Queried port	A
s2	Current status of RTS/CTS handshaking protocol	ON, OFF
*cc	Checksum	*00-*FF

Example

```
$PASHQ,CTS
$PASHR,CTS,ON*1D
```

Relevant Set Command \$PASHS,CTS

See also \$PASHQ,PRT
\$PASHQ,MDP

DBN,MSI: DBEN Message Status

Function This command is used in a base receiver to read the current settings of the DBEN messages the base currently generates and outputs.

Command Format Syntax
\$PASHQ,DBN,MSI[*cc]

Response Format Syntax
\$PASHR,DBN,MSI,d1,RPC,d2,BPS,d3*cc

Parameters

Parameter	Description	Range
d1	Number of DBEN messages currently output (always 2)	2
RPC,d2	"RPC" message type output rate, in seconds	0-300
BPS,d3	"BPS" message type output rate, in seconds	0-300
*cc	Checksum	*00-*FF

Example
\$PASHQ,DBN,MSI
\$PASHR,DBN,MSI,2,RPC,1.0,BPS,30.0*6B

See also
\$PASHS,DBN,TYP
\$PASHQ,BAS
\$PASHQ,CPD,MOD

DCR: Cartesian Coordinates of Baseline

Function This command allows you to output the DCR message containing the ECEF components of the baseline for the last computed position as well as other information on the position solution.

Command Format Syntax
`$PASHQ,DCR[*cc]`

Response Format Syntax
`$PASHR,DCR,d1,d2,m3,f4,f5,f6,f7,f8,f9,f10,f11,f12,f13,f14,f15,s16*cc`

Parameters

Parameter	Description	Range
d1	Position mode: <ul style="list-style-type: none"> • 0: Autonomous • 1: RTCM (or SBAS differential) • 2: RTK float • 3: RTK fixed • 9: SBAS Differential. See comment. 	0-3, 9
d2	Count of SVs used in position computation	3-27
m3	UTC time (hhmmss.ss)	000000.00-235959.99
f4	ECEF X component of baseline, in meters	± 99999.999
f5	ECEF Y component of baseline, in meters	±99999.999
f6	ECEF Z component of baseline, in meters	±9999.999
f7	Receiver clock offset, in meters	±300000.000
f8	Velocity vector, X component, in m/s	±9.999
f9	Velocity vector, Y component, in m/s	±9.999
f10	Velocity vector, Z component, in m/s	±9.999
f11	Receiver clock drift, in m/s	±2000.000
f12	PDOP	0.0-99.9
f13	HDOP	0.0-99.9
f14	VDOP	0.0-99.9
f15	TDOP	0.0-99.9
s16	Firmware version ID (GNSS board fw)	4-char string
*cc	Checksum	*00-FF

Example

```
$PASHQ,DCR
$PASHR,DCR,3,09,130924.00,-37.683,55.081,17.925,0.109,0.001,
0.002,0.001,0.047,1.9,1.0,1.6,1.1,G010*71
```

Comment

The code allotted to a position solution of the SBAS differential type is either “1” or “9”, depending on the last \$PASHS,NPT command run.

See also \$PASHS,NME
\$PASHS,NPT

DDS: Differential Decoder Status

Function This command allows you to output a message providing status data on the corrections received.

Command Format **Syntax**
\$PASHQ,DDS[*cc]

Response Format **Syntax**
\$PASHR,DDS,d1,m2,d3,c4,s5,c6,d7,d8,d9,d10,d11,f12,f13,d14,n(d15, f16,f17)*cc

Parameters

Parameter	Description	Range
d1	Differential decoder number	1-3
m2	GNSS (output) time tag	000000.00-235959.99
d3	Cumulative counter of stream change	0-255
c4	ID of port from which corrections are received	A, C, D, E
s5	Protocol detected (empty means “no data”)	RT2, RT3, CMR, DBN, TPZ, ATM
d6	Time window, in seconds: • “0” if not defined or just initialized • “255” means equal to or greater than 255	0-255
d7	Percentage of estimated overall data link quality/availability. Empty if not defined.	0-100
d8	Percentage of deselected information. Empty if not defined.	0-100
d9	CRC percentage. Empty if not defined.	0-100
d10	Standard of latency, in milli-seconds	0-16383
d11	Mean latency, in milli-seconds	0-16383
f12	Mean epoch interval, in seconds	0.00-163.86

Parameter	Description	Range
f13	Min epoch interval, in seconds	0.00-20.47
d14	Number (n) of different messages detected since last stream change	0-63
d15	Message type	RT2: 1-63 RT3: 1001-4094 CMR: 0(obs), 1(loc), 2(desc), 3(glo), 12(cmr+) DBN: 10(RPC), 11(BPS) TPZ: 0 only ATM: 0-15
f16	Interval of last message, in seconds	0.000-1023.000
f17	Age of last message, in seconds	0.000-1023.000
*cc	Checksum	

Example**\$PASHQ,DDS**

```
$PASHR,DDS,1,140235.33,A,RT3,200,100,0,100,5,50,1.05,1.00,3,1004,1.00
0,0.500,1005,30.000,18.000,1006,30.000,18.000*49
```

See Also

\$PASHS,NME

DIP: Direct IP Parameters

Function

This command is used to query the parameters used for a Direct IP connection. When c6 is omitted in the query command, the returned Direct IP settings are those for the port defined through the \$PASHS,DIP,PAR or \$PASHS,DIP command last run.

Command Format**Syntax**

```
$PASHQ,DIP[,c6]*cc
```

Response Format**Syntax**

```
$PASHR,DIP,RIP,s1,PRT,d2[,LGN,s3,PWD,s4]*cc
```

Parameters

Parameter	Description	Range
RIP,s1	IP address (xxx.xxx.xxx.xxx) or host name	IP address: 000.000.000.000 to 255.255.255.255 or host name
PRT,d2	Port number	0-65535
LGN,s3	User name (optional)	20 char. max.
PWD,s4	Password (optional)	20 chars max.
*cc	Checksum	*00.*FF

Examples

\$PASHQ,DIP

\$PASHR,DIP,RIP,192.65.54.1,PRT,80*xx

\$PASHQ,DIP

\$PASHR,DIP,RIP,www.ashtech.com,PRT,8080*xx

**Relevant Set
Command** \$PASHS,DIP

See also \$PASHQ,MDM

DPO: Delta Position

Function This command is used to output a DPO message containing the components of the last computed vector (baseline) as well as other information about the position solution.

Command Format Syntax
\$PASHQ,DPO[*cc]

Response Format Syntax
\$PASHR,DPO,d1,d2,m3,f4,c5,f6,c7,f8,c9,f10,f11,f12,f13,f14,f15,f16,s17*cc

Parameters

Parameter	Description	Range
d1	Position mode: <ul style="list-style-type: none"> • 0: Autonomous • 1: RTCM (or SBAS differential) • 2: RTK float • 3: RTK fixed • 9: SBAS Differential. See comment. 	0-3, 9
d2	Count of SVs used in position computation	3-27
m3	UTC time (hhmmss.ss)	000000.00-235959.99
f4	Northing coordinate difference, in meters	±9999999.999
c5	North label	N
f6	Easting coordinate difference, in meters	± 9999999.999
c7	East label	E
f8	Ellipsoid height difference, in meters	± 999999.999
c9	Reserved	±9.999
f10	COG: Course Over Ground, in degrees	0-359.9
f11	SOG: Speed Over Ground, in m/s	0-9.999
f12	Vertical velocity, in m/s	± 999.9
f13	PDOP	0.0-99.9
f14	HDOP	0.0-99.9
f15	VDOP	0.0-99.9
f16	TDOP	0.0-99.9
s17	Firmware version ID	4-character string
*cc	Checksum	*00.*FF

Example

```
$PASHQ,DPO
$PASHR,DPO,3,09,131143.50,40.910,N,54.072,E,-13.363,,0.0,0.0,-0.0,1.9,
1.0,1.6,1.2,G010*5B
```

Comment

The code allotted to a position solution of the SBAS differential type is either “1” or “9”, depending on the last \$PASHS,NPT command run.

See also \$PASHS,NME
\$PASHS,NPT

DRI: Raw Data Recording Rate

Function This command queries the current recording rate for all raw data logged in the internal or external memory.

Command Format Syntax
\$PASHQ,DRI[*cc]

Response Format Syntax
\$PASHR,DRI,f1*cc

Parameters

Parameter	Description	Range
f1	Current raw data recording rate	0.05 s 0.1-0.9 s 1-999 s
*cc	Checksum	*00-*FF

Example

```
$PASHQ,DRI
$PASHR,DRI,1.00*18
```

Relevant Set Command \$PASHS,DRI

See also \$PASHQ,ATM
\$PASHQ,REC

DSY: Daisy Chain Status

Function This command queries the receiver for the status of the daisy chain function.

Command Format Syntax
\$PASHQ,DSY[*cc]

Parameters
 None.

Response Format Syntax
\$PASHR,DSY,OFF*59
 or
\$PASHR,DSY,c1,c2,d3*cc

Parameters

Parameter	Description	Range
c1	Source port: <ul style="list-style-type: none"> • A: Serial port • C: Bluetooth port • D: Radio • E: Modem 	A, C, D, E
c2	Destination port: <ul style="list-style-type: none"> • A: Serial port • C: Bluetooth port • D: Radio • E: Modem 	A, C, D, E
d3	Mode: <ul style="list-style-type: none"> • 0: Raw (default) • 1: Block 	0,1
*cc	Checksum	*00-*FF

Example

Command reporting data on port A forwarded to port C:

```
$PASHQ,DSY
$PASHR,DSY,A,C*38
```

Relevant Set Command \$PASHS,DSY

DTM: Datum Reference

Function This command asks the receiver to output the content of the NMEA DTM message.

Command Format Syntax
`$PASHQ,DTM[*cc]`

Parameters

None.

Response Format Syntax
`$GPDTM,s1,,f2,c3,f4,c5,f6,s7*cc`

Parameters

Parameter	Description	Range
s1	Local datum code: <ul style="list-style-type: none"> W84: WGS84 used as local datum 999: Local datum computed using the parameters provided by the RTCM3.1 data stream. 	W84, 999
f2	Latitude offset, in meters	0-59.999999
c3	Direction of latitude	N, S
f4	Longitude offset, in meters	0-59.999999
c5	Direction of longitude	E, W
f6	Altitude offset, in meters	±0-99.999
s7	Reference datum code	W84
*cc	Checksum	*00-*FF

Example

```
$PASHQ,DTM
$GPDTM,999,2.324525,N,1.499476,W,1.365,W84*37
```

See Also \$PASHS,NME

Automatic Output of DTM Messages This is a reminder on how to output DTM messages at regular intervals of time: Use the \$PASHS,NME command with the syntax below:

```
$PASHS,NME,DTM,<port_ID>,ON,<Rate>
```

For more details on the \$PASHS,NME command, refer to the *Set Command Library* Chapter.

As an example, the command below will output DTM messages on port A at a rate of 2 seconds:

\$PASHS,NME,DTM,A,ON,2

DYN: Receiver Dynamics

Function This command allows you to query the current setting for the receiver dynamics.

Command Format Syntax
 \$PASHQ,DYN[*cc]

Response Format Syntax
 \$PASHR,DYN,d*cc

Parameters

Parameter	Description	Range
d	Receiver dynamics: <ul style="list-style-type: none"> • 1: Static • 2: Quasi-static • 3: Walking • 4: Ship • 5: Automobile • 6: Aircraft • 7: Unlimited • 8: Adaptive • 9: User-defined 	1-9
*cc	Checksum	*00-*FF

Example

```
$PASHQ,DYN
$PASHR,DYN,8*33
```

Relevant Set Command \$PASHS,DYN

See also \$PASHS,UDP

ELM: Elevation Mask

Function This command is used to read the current value of the elevation mask. The elevation mask impacts data recording, data output and satellite reception at the base.

Command Format Syntax
 \$PASHQ,ELM[*cc]

Response Format Syntax
 \$PASHR,ELM,d1*cc

Parameters

Parameter	Description	Range
d1	Current value of elevation mask, in degrees	0-90
*cc	Checksum	*00-*FF

Example
 \$PASHQ,ELM
 \$PASHR,ELM,5*29

Relevant Set Command \$PASHS,ELM

See also \$PASHQ,PEM

FIL,CUR: Information On G-File Being Recorded

Function This command allows you to read information about the G-file currently being recorded.

Command Format Syntax
 \$PASHQ,FIL,CUR[*cc]

Response Format Syntax
 General form:
 \$PASHR,FIL,CUR,s1,d2,s3,s4,d5*cc

If no G-file recording is in progress:
 \$PASHR,FIL,CUR,NONE*79

Parameters

Parameter	Description	Range
s1	Filename (including path)	255 characters max.
d2	Size in bytes	0-134217728
s3	Date (ddmmyyyy)	
s4	Time (hhmmss)	000000-235959
d5	Memory location: <ul style="list-style-type: none"> • 0: Internal memory. • 2: USB key. 	0, 2
*cc	Checksum	*00-*FF

Example

\$PASHQ,FIL,CUR

\$PASHR,FIL,CUR,GazerA09.123,1769897,14032009,130850,0*63

See Also \$PASHS,REC
\$PASHS,MEM

FIL,LST: Listing Files in Receiver Memory or USB Key

Function This command allows you to list the names of the files stored in the receiver's internal memory or on the USB key connected to the receiver.

Command Format Syntax

\$PASHQ,FIL,LST[,c][,s][*cc]

Parameters

Parameter	Description	Range
c	Memory type: <ul style="list-style-type: none"> • c=0 (or c omitted): Internal memory • c omitted: Memory is as defined with \$PASHS,MEM • c=2: USB key 	0, 2
s	Path name	
*cc	Optional checksum	*00-*FF

Response format Syntax

\$PASHR,FIL,LST,d1,d2,s3,d4,s5,s6[,c7]*cc

Parameters

Parameter	Description	Range
d1	Number of files	

Parameter	Description	Range
d2	File index	
s3	File name or directory name	255 characters max.
d4	Size in bytes	0-134217728
s5	Date (ddmmyyyy)	
s6	Time (hhmmss)	000000-235959
c7	=D when s3 is a directory name	D
*cc	Optional checksum	*00-*FF

Example

\$PASHQ,FIL,LST*53

\$PASHR,FIL,LST,4,0,GazerA09.123,1769897,14032009,130850*74

\$PASHR,FIL,LST,4,1,GazerB09.123,1769876,10032009,110952*7C

\$PASHR,FIL,LST,4,2,GazerC09.123,1769787,01032009,181856*72

\$PASHR,FIL,LST,4,3,GazerD09.123,1769787,01032009,181856*74

See Also \$PASHS,REC
\$PASHS,MEM
\$PASHQ,FLS

FLS: List of Raw Data Files

Function This command is used to list the raw data files stored in the selected memory (cf. \$PASHS,MEM). An index number is used in the command format to limit the number of listed files. Files are listed in blocks of 10 files.

Command Format Syntax

\$PASHQ,FLS,d[*cc]

Parameters

Parameter	Description	Range
d	File index number ("0" for 1st file, "1" for 2nd file, etc.). All files with index number equal to or greater than this number will be listed. If d is greater than the highest file index number, the command is "NAKed".	0-999
*cc	Optional checksum	*00-*FF

Response Format Syntax

\$PASHR,FLS,d1,d2,d3,n(s4,m5,d6)*cc

Parameters

Parameter	Description	Range
d1	Free memory space, in kbytes, in the selected memory	000000-999999
d2	Total number of files currently stored in the selected memory	000-999
d3	Number of files listed corresponding to those matching the command criterion	00-10
s4	Site name assigned to the file	4 characters
m5	File time in the "wwwdhhmm" format where: <ul style="list-style-type: none"> • www: GPS week number • d: Day in week • hh: Time (hours) • mm: Time (minutes) 	0000-9999 1-7 00-23 00-59
d6	File size in kbytes	0-999999
*cc	Checksum	*00-*FF

Example Listing the files from index number "10":

```
$PASHQ,FLS,10
$PASHR,FLS,65240,012,02,sit3,146821321,7,sit3,146821321,4*06
```

See also \$PASHS,REC
\$PASHS,FIL,D
\$PASHS,MEM

GAL: GALILEO Tracking Status

Function This command queries the receiver for the current GALILEO tracking status.

Command Format Syntax
\$PASHQ,GAL[*cc]

Response Format Syntax
\$PASHR,GAL,s1*cc

Parameters

Parameter	Description	Range
s1	Differential decoder number <ul style="list-style-type: none"> • ON: GALILEO satellites currently tracked and used • OFF (default): GALILEO satellites not currently tracked 	ON, OFF
*cc	Checksum	

Example \$PASHQ,GAL
 \$PASHR,GAL,ON*1D

See Also \$PASHS,GAL

GGA: GNSS Position Message

Function This command is used to output a GGA message containing the last computed position. If no position is computed, the message will be output anyway, but with some blank fields.

Command Format Syntax
 \$PASHQ,GGA[*cc]

Response Format Syntax
 \$GPGGA,m1,m2,c3,m4,c5,d6,d7,f8,f9,M,f10,M,f11,d12*cc

Parameters

Parameter	Description	Range
m1	Current UTC time of position (hhmmss.ss)	000000.00-235959.99
m2	Latitude of position (ddmm.mmmmmm)	0-90 0-59.999999
c3	Direction of latitude	N, S
m4	Longitude of position (dddmm.mmmmmm)	0-180 0-59.999999
c5	Direction of longitude	E,W
d6	Position type: <ul style="list-style-type: none"> • 0: Position not available or invalid • 1: Autonomous position • 2: RTCM Differential (or SBAS Differential) • 3: Not used • 4: RTK fixed • 5: RTK float • 9: SBAS Differential. See comment. 	0-5, 9
d7	Number of GNSS Satellites being used in the position computation	
f8	HDOP	0-99.9
f9,M	Altitude, in meters, above mean seal level. "M" for meters	± 99999.999,M

Parameter	Description	Range
f10,M	Geoidal separation in meters. "M" for meters. Based on the official NATO's standard mean-sea-level algorithm (5-degree grid of height).	± 999.999,M
f11	Age of differential corrections, in seconds	0-
d12	Base station ID (RTCM only)	0-4095
*cc	Checksum	*00.*FF

Example**\$PASHQ,GGA**

```
$GPGGA,131745.00,4717.960847,N,00130.499476,W,4,10,0,8,35.655,M,
47.290,M,3.0,1000*61
```

Comment

The code allotted to a position solution of the SBAS differential type is either "2" or "9", depending on the last \$PASHS,NPT command run.

Automatic Output of GGA Messages

This is a reminder on how to output GGA messages at regular intervals of time: Use the \$PASHS,NME command with the syntax below:

```
$PASHS,NME,GGA,<port_ID>,ON,<Rate>
```

For more details on the \$PASHS,NME command, refer to the *Set Command Library* Chapter.

As an example, the command below will output GGA messages on port A at a rate of 0.5 second:

```
$PASHS,NME,GGA,A,ON,0.5
```

GLL: Geographic Position - Latitude/Longitude

Function

This command is used to output a GLL message containing the last computed position. The message is output on the port on which the query is made. If no position is computed, the message will be output anyway, but all position-related fields will be blank.

Command Format**Syntax**

```
$PASHQ,GLL[*cc]
```

Response Format**Syntax**

```
$GPGLL,m1,c2,m3,c4,m5,c6,c7*cc
```

Parameters

Parameter	Description	Range
m1	Latitude of position (ddmm.mmmmmm)	0-90 0-59.999999
c2	Direction of latitude	N, S
m3	Longitude of position (dddmm.mmmmmm)	0-180 0-59.999999
c4	Direction of longitude	E, W
m5	Current UTC time of position (hhmmss.ss)	000000.00- 235959.99
c6	Status <ul style="list-style-type: none"> • A: Data valid • V: Data not valid 	A, V
c7	Mode indicator: <ul style="list-style-type: none"> • A: Autonomous mode • D: Differential mode • N: Data not valid 	A, D, N
*cc	Checksum	*00-*FF

Example

\$PASHQ, GLL

\$GPGLL,4717.960853,N,00130.499473,W,132331.00,A,D*7D

Automatic Output of GLL Messages

This is a reminder on how to output GLL messages at regular intervals of time: Use the \$PASHS,NME command with the syntax below:

\$PASHS,NME,GLL,<port_ID>,ON,<Rate>

For more details on the \$PASHS,NME command, refer to the *Set Command Library* Chapter.

As an example, the command below will output GLL messages on port A at a rate of 0.5 second:

\$PASHS,NME,GLL,A,ON,0.5

GLO: GLONASS Tracking Status

Function This command is used to query the GLONASS tracking status.

Command Format Syntax
\$PASHQ,GLO[*cc]

Response Format Syntax
\$PASHR,GLO,s*cc

Parameters

Parameter	Description	Range
s	ON: GLONASS satellites currently tracked and used. OFF: GLONASS satellites not tracked.	ON, OFF
*cc	Checksum	*00-*FF

Example

```
$PASHQ,GLO
$PASHR,GLO,ON*1D
```

Relevant Set Command \$PASHS,GLO

GNS: GNSS Fix Data

Function This command allows you to output the standard NMEA GNS message.

If there is no computed position available when you request the message, the message will nonetheless be output, but with all the position-related fields left blank.

Command Format Syntax
\$PASHQ,GNS[*cc]

Response Format Syntax
\$--GNS,m1,m2,c3,m4,c5,s6,d7,f8,f9,f10,f11,d12*cc

If the receiver is configured in GPS mode only, then the message header is \$GPGNS. If it's configured in GPS/GLONASS mode, then the message header is \$GNGNS.

Parameters

Parameter	Description	Range
m1	Current UTC time of position (hhmmss.ss)	000000.00-235959.99
m2	Latitude of position (ddmm.mmm-mmm)	0-90 0-59.999999
c3	Direction of latitude	N, S
m4	Longitude of position (dddmm.mmm-mmm)	0-180 0-59.999999
c5	Direction of longitude	E, W
s6	Mode indicator (1 character by constellation): • N: No fix • A: Autonomous position • D: Differential • R: RTK Fixed • F: RTK Float	N, A, D, R, F
d7	Number of GNSS satellites being used in the position computation.	3-26
f8	HDOP	0-99.9
f9	Altitude above mean sea level.	±99999.999
f10	Geoidal separation, in meters	±999.999
f11	Age of differential corrections, in s	0-999
d12	Base station ID (RTCM only)	0-4095
*cc	Checksum	

Example

\$PASHQ,GNS

\$GNGNS,131745.00,4717.960847,N,00130.499476,W,RR,10,0.8,35.655,47.290,3.0,1000*61

See Also

\$PASHS,NME

Automatic Output of GNS Messages

This is a reminder on how to output GNS messages at regular intervals of time: Use the \$PASHS,NME command with the syntax below:

\$PASHS,NME,GNS,<port_ID>,ON,<Rate>

For more details on the \$PASHS,NME command, refer to the *Set Command Library* Chapter.

As an example, the command below will output GNS messages on port A at a rate of 10 seconds:

```
$PASHS,NME,GNS,A,ON,10
```

GPS: GPS Tracking Status

Function This command queries the receiver for the current GPS tracking status.

Command Format Syntax
\$PASHQ,GPS[*cc]

Response Format Syntax
\$PASHR,GPS,s1[,s2[,s3[,s4]]]*ccc

Parameters

Parameter	Description	Range
s1	GPS tracking status: • ON: GPS satellites currently tracked and used • OFF: GPS satellites not currently tracked	ON, OFF
s2	First Signal: • 1C: Tracking GPS L1 C/A signal	1C
s3	Second Signal: • 2L: Tracking L2CS signal for all GPS SVs • 2W: Tracking L2P signal for all GPS SVs • 2LW: Tracking L2CS signal for L2CS-capable GPS SVs and L2P for others • 5Q: Tracking L5 signal for all GPS SVs • "Blank": No second signal to be tracked	2L, 2W, 2LW, 5Q or "blank"
s4	Third Signal: • 2L: Tracking L2CS signal for all GPS SVs • 5Q: Tracking L5 signal for all GPS SVs • "Blank": No third signal to be tracked	2L, 5Q or "blank"
*cc	Optional checksum	*00-*FF

Example \$PASHQ,GPS
\$PASHR,GPS,ON,1C,2W*1D

Relevant Set \$PASHS,GPS
Command

GRS: GNSS Range Residuals

Function This command is used to output a GRS message containing the satellite range residuals. The message is output on the port on which the query is made. No message will be output if there is no position computed.

Command Format Syntax
`$PASHQ,GRS[*cc]`

Response Format Syntax
`$--GRS,m1,d2,n(f3)*cc`

Parameters

Parameter	Description	Range
"\$--GRS" Header	\$GPGRS: Only GPS satellites are used. \$GLGRS: Only GLONASS satellites are used. \$NGRS: Several constellations (GPS, SBAS, GLONASS) are used.	\$GPGRS, \$GLGRS, \$NGRS
m1	Current UTC time of position (hhmmss.ss)	000000.00- 235959.99
d2	Mode used to compute range residuals	Always "1"
f3	Range residual for satellite used in position computation (repeated "n" times, where n is the number of satellites used in position computation). Residuals are listed in the same order as the satellites in the GSV message so that each residual provided can easily be associated with the right satellite.	±999.999
*cc	Checksum	*00-*FF

Example `$PASHQ,GRS`
`$NGRS,141003.50,1,1.14,-0.48,0.26,0.20,-0.94,-0.28,-1.18*61`
`$NGRS,141003.50,1,-0.20*4F`

Automatic Output of GRS Messages This is a reminder on how to output GRS messages at regular intervals of time: Use the \$PASHS,NME command with the syntax below:

`$PASHS,NME,GRS,<port_ID>,ON,<Rate>`

For more details on the \$PASHS,NME command, refer to the *Set Command Library* Chapter.

As an example, the command below will output GRS messages on port A at a rate of 0.5 second:

\$PASHS,NME,GRS,A,ON,0.5

GSA: GNSS DOP and Active Satellites

Function This command is used to output a GSA message containing data related to DOP values and satellites used in the position solution.

Command Format Syntax
\$PASHQ,GSA[*cc]

Response Format Syntax
\$--GSA,c1,d2,d3,d4,d5,d6,d7,d8,d9,d10,d11,d12,d13,d14,f15,f16,f17*cc

Parameters

Parameter	Description	Range
"\$--GSA" Header	\$GPGSA: Only GPS satellites are used. \$GLGSA: Only GLONASS sats are used. \$GNGSA: Several constellations (GPS, SBAS, GLONASS) are used.	\$GPGSA, \$GLGSA, \$GNGSA
c1	Output mode: • M: Manual • A: Automatic	M, A
d2	Position indicator: • 1: No position available • 2: 2D position • 3: 3D position	1-3
d3-d14	Satellites used in the position solution (blank fields for unused channels)	GPS: 1-32 GLONASS: 65-96 SBAS: 33-64
f15	PDOP	0-9.9
f16	HDOP	0-9.9
f17	VDOP	0-9.9
*cc	Checksum	*00-*FF

Example
\$PASHQ,GSA
\$GNGSA,A,3,20,11,13,23,17,04,31,,,,,1.6,0.9,1.3*21
\$GNGSA,A,3,81,83,68,,,,,,,1.6,0.9,1.3*2C

Automatic Output of GSA Messages

This is a reminder on how to output GSA messages at regular intervals of time: Use the \$PASHS,NME command with the syntax below:

\$PASHS,NME,GSA,<port_ID>,ON,<Rate>

For more details on the \$PASHS,NME command, refer to the *Set Command Library* Chapter.

As an example, the command below will output GSA messages on port A at a rate of 0.5 second:

```
$PASHS,NME,GSA,A,ON,0.5
```

GST: GNSS Pseudo-Range Error Statistics

Function This command is used to output a GST message containing standard deviations relevant to the position solution.

Command Format Syntax
\$PASHQ,GST[*cc]

Response Format Syntax
\$--GST,m1,f2,f3,f4,f5,f6,f7,f8*cc

Parameters

Parameter	Description	Range
"\$--GST" Header	\$GPGST: Only GPS satellites are used. \$GLGST: Only GLONASS satellites are used. \$NGGST: Several constellations (GPS, SBAS, GLONASS) are used.	\$GPGST, \$GLGST, \$NGGST
m1	Current UTC time of position (hhmmss.ss)	000000.00- 235959.99
f2	RMS value of standard deviation of range inputs (DGNSS corrections included), in meters	0.000-99.999
f3	Standard deviation of semi-major axis of error ellipse, in meters	0.000-99.999
f4	Standard deviation of semi-minor axis of error ellipse, in meters	0.000-99.999
f5	Orientation of semi-major axis of error ellipse, in degrees from true North	0.000-99.999
f6	Standard deviation of latitude error, in meters	0.000-99.999
f7	Standard deviation of longitude error, in meters	0.000-99.999
f8	Standard deviation of altitude error, in meters	0.000-99.999
*cc	Checksum	*00-*FF

Example **\$PASHQ,GST**
\$NGGST,154013.80,0.642,1.746,1.303,27.197,1.663,1.407,2.456*79

Automatic Output of GST Messages This is a reminder on how to output GST messages at regular intervals of time: Use the \$PASHS,NME command with the syntax below:

\$PASHS,NME,GST,<port_ID>,ON,<Rate>

For more details on the \$PASHS,NME command, refer to the *Set Command Library* Chapter.

As an example, the command below will output GST messages on port A at a rate of 0.5 second:

\$PASHS,NME,GST,A,ON,0.5

GSV: GNSS Satellites in View

Function This command is used to output a GSV message containing information on the satellites in view.

Command Format Syntax
\$PASHQ,GSV[*cc]

Response Format Syntax
\$--GSV,d1,d2,d3,n(d4,d5,d6,f7)*cc

The set of parameters (d4,d5,d6,f7) can be repeated up to 4 times in a single response line, corresponding to the description of 4 different satellites. The number of response lines is therefore dependent on the number of satellites in view (e.g. three response lines if between 9 and 12 satellites are visible).

Parameters

Parameter	Description	Range
"\$--GSV" Header	\$GPGSV: GPS and SBAS satellites. \$GLGSV: GLONASS satellites \$GAGSV: GALILEO satellites	\$GPGSV, \$GLGSV \$GAGSV
d1	Total number of messages	1-4
d2	Message number	1-4
d3	Total number of satellites in view	1-15
d4	Satellite PRN	GPS: 1-32 GLONASS: 65-96 SBAS: 33-64 GALILEO: 97-126 GIOVE-A/B: 127-128
d5	Elevation in degrees	0-90
d6	Azimuth in degrees	0-359
f7	SNR in dB.Hz	30.0-60.0
*cc	Checksum	*00-*FF

GPS PRN number is d4
 SBAS PRN number is d4+87
 GLONASS slot number is d4-64
 GALILEO PRN number is d4-96

Example **\$PASHQ,GSV**

```
$GPGSV,2,1,07,20,61,066,50,11,30,146,36,13,41,200,50,23,73,134,52*7C
$GPGSV,2,2,07,33,34,198,42,17,40,242,50,04,37,304,48*47
$GLGSV,1,1,04,77,29,098,46,84,19,332,46,83,49,276,52,68,57,300,52*67
```

Automatic Output of GSV Messages

This is a reminder on how to output GSV messages at regular intervals of time: Use the \$PASHS,NME command with the syntax below:

```
$PASHS,NME,GSV,<port_ID>,ON,<Rate>
```

For more details on the \$PASHS,NME command, refer to the *Set Command Library* Chapter.

As an example, the command below will output GSV messages on port A at a rate of 10 seconds:

```
$PASHS,NME,GSV,A,ON,10
```

LCS: Local Coordinate System Status

Function This command asks the receiver to indicate the coordinate system it currently uses to deliver its position solution. A local coordinate system may be used provided its characteristics are received through the appropriate RTCM 3.1 message (1021, 1022 or 1023) from the base used.

Command Format **Syntax**
\$PASHQ,LCS[*cc]

Parameters

None.

Response Format **Syntax**
\$PASHR,LCS,s*cc

Parameters

Parameter	Description	Range
s	Status: <ul style="list-style-type: none"> • ON: Local coordinate system used when available • OFF: Coordinate system used is WGS84 necessarily. 	ON, OFF
*cc	Checksum	*00-*FF

Example

\$PASHQ,LCS

\$PASHR,LCS,ON*05

Relevant Set Command

\$PASHS,LCS

LOG: Editing a Log File

Function This command is used to edit the specified or current log file. A log file lists all events related to IP connections with the receiver.

Command Format Syntax

`$PASHQ,LOG[,d][*cc]`

Parameters

Parameter	Description	Range
d	Index number of the log file you want to edit. If d is omitted, the current log file is edited.	0-900
*cc	Optional checksum	*00-*FF

Response format Syntax

The response is formatted as follows:

```
Date: <Year>-<Month>-<Day>
Maximum size: x Mb Duration: xx days
hh:mm:ss: <message 1>
hh:mm:ss: <message 2>
...
hh:mm:ss: <message n>
```

Parameters

- The first line contains the date when the log file was created.
- The second line indicates the maximum size (in Mb) permitted for the file as well as the time, in days, during which it is kept in memory.
- Each of the lines that follow contains a message that describes a connection event (time of event, beginning or end of connection, type of connection, identification of the connected device).

Example

See Also \$PASHS,LOG,PAR
\$PASHS,LOG,DEL
\$PASHQ,LOG,LST

LOG,LST: Listing Log Files

Function This command is used to read the list of log files present in the receiver.

Command Format Syntax
\$PASHQ,LOG,LST[*cc]

Parameters
 None.

Response format Syntax
\$PASHR,LOG,LST,d1,d2,s3,d4*cc

Parameters

Parameter	Description	Range
d1	Current number of log files in the receiver	0-900
d2	File index	0-900
s3	Filename	255 characters max.
d4	Size, in bytes	0-134217728
*cc	Optional checksum	*00-*FF

Example

```
$PASHQ,LOG,LST*54
$PASHR,LOG,LST,4,0,20090408.log,1769897*01
$PASHR,LOG,LST,4,1,20090407.log,1769876*00
$PASHR,LOG,LST,4,2,20090406.log,1769787*03
$PASHR,LOG,LST,4,3,20090405.log,1769787*01
```

Relevant Set Command \$PASHS,LOG,PAR
 \$PASHS,LOG,DEL
 \$PASHQ,LOG

LOG,PAR: Log File Settings

Function This command is used to read the settings of any new log file created in the receiver.

Command Format Syntax
\$PASHQ,LOG,PAR[*cc]

Parameters

None.

Response format Syntax

\$PASHR,LOG,PAR,s1,d2,d3*cc

Parameters

Parameter	Description	Range
s1	Log file control parameter: • ON: Generation of log files enabled • OFF: Generation of log files disabled	ON, OFF
d2	Maximum size, in Mbytes	1-90
d3	Number of days during which a log file is kept in memory.	1-100
*cc	Optional checksum	*00-*FF

Example

\$PASHQ,LOG,PAR*5C

\$PASHR,LOG,PAR,OFF,1,20*0F

Relevant Set Command \$PASHS,LOG,PAR

MDM: Modem Status and Parameters

Function This command is used to query the modem parameters.

Command Format Syntax

\$PASHQ,MDM[*cc]

Response Format Syntax

\$PASHR,MDM,c1,d2,s3,PWR=s4,PIN=s5,BND=d6,PTC=d7,CBS=d8,APN=s9,LGN=s10,PWD=s11,IPT=d12,PHN=s13,ADL=c14,RNO=d15,MOD=s16,NET=d17*cc

Parameters

Parameter	Description	Range
c1	Modem port	E
d2	Modem baud rate	9
s3	Modem state "NONE" means that the modem option [Z] is not valid.	OFF, ON, INIT, DIALING, ONLINE, NONE

Parameter	Description	Range
PWR=s4	Power mode: • AUT: Automatic • MAN: Manual	AUT, MAN
PIN=s5	PIN code	4-8 digits
BND=d6	Band: • 0: 850/1900 (North America) • 1: 900/1800 (Europe) • 2: 900/1900	0-2
PTC=d7	Protocol: • 0: CSD • 1: GPRS	0-1
CBS=d8	CSD mode: • 0: V.32 9600 bauds • 1: V.110 9600 bauds ISDN	0-1
APN=s9	Access Point Name (GPRS)	32 char. max.
LGN=s10	Login (GPRS)	32 char. max.
PWD=s11	Password (GPRS)	32 char. max.
IPT=d12	Internet Protocol: • 0: TCP • 1: UDP	0-1
PHN=s13	Phone number (CSD)	20 digits max.
ADL=c14	Auto-dial mode	Y, N
RNO=d15	Maximum number of re-dials (CSD)	0-15
MOD=s16	Modem model (empty if unknown)	Q2687, Q26 Extreme
NET=d17	2G/3G selection mode: • 0: Automatic (2G or 3G) • Forced to operate in 2G	0-1
*cc	Checksum	*00-*FF

Example

\$PASHQ,MDM

```
$PASHR,MDM,E,9,ONLINE,PWR=MAN,PIN=,BND=1,PTC=1,CBS=1,
APN=a2bouygtel.com,LGN=,PWD=,IPT=0,PHN=,ADL=Y,RNO=2,
MOD=Q26 Extreme,NET=1*47
```

Relevant Set Command \$PASHS,MDM

See also \$PASHQ,MDM,LVL
\$PASHQ,MWD
\$PASHS,NTR
\$PASHS,DIP
\$PASHS,MDM,DAL

MDM,LVL: Modem Signal Level

Function This command is used to query the current level of the modem signal.

Command Format Syntax
 \$PASHQ,MDM,LVL[*cc]

Response Format Syntax
 \$PASHR,MDM,LVL,d*cc

Parameters

Parameter	Description	Range
d	Current signal level: <ul style="list-style-type: none"> • 0-100: Signal level. The higher the number, the higher the signal level. • "-1": No signal available. 	0 to 100 -1
*cc	Checksum	*00-*FF

Example

```
$PASHQ,MDM
$PASHR,MDM,LVL,-1*7A
```

See also \$PASHQ,MDM

MDM,STS: Modem Status

Function This command queries the receiver for the current status of the internal modem.

Command Format Syntax
 \$PASHQ,MDM,STS[*cc]

Response Format Syntax
 \$PASHR,MDM,STS,s1,s2,s3,d4*cc

Parameters

Parameter	Description	Range
s1	Modem status. "NONE" means that the [Z] option (MODEM) is not valid.	OFF, ON, INIT, DIALING, ONLINE, NONE
s2	Name of the network currently used	-
s3	Network type currently used (2G or 3G)	2G, 3G
d4	Signal level. "-1" means the indication of signal level is not available.	-1; 0-100
*cc	Optional checksum	*00-*FF

Example

```
$PASHQ,MDM,STS
$PASHR,MDM,STS,INIT,"Orange F",2G,60*77
```

See Also

```
$PASHQ,MDM
```

MDP: Port A Setting

Function

This command is used to read the current setting of port A.

Command Format

Syntax

```
$PASHQ,MDP[*cc]
```

Response Format

Syntax

```
$PASHR,MDP,A,s*cc
```

Parameters

Parameter	Description	Range
s	Current port setting (RS232 or RS422)	232, 422
*cc	Checksum	*00-*FF

Example

```
$PASHQ,MDP
$PASHR,MDP,A,RS232*5E
```

Relevant Set Command

```
$PASHS,MDP
```

See also \$PASHQ,CTS

MEM: Selected Memory Device

Function This command is used to query the memory device used by the receiver.

Command Format Syntax
\$PASHQ,MEM[*cc]

Response Format Syntax
\$PASHR,MEM,d[*cc]

Parameters

Parameter	Description	Range
d	Memory used: • 0: Internal memory (NAND Flash) • 2: USB mass storage key	0, 2
*cc	Checksum	*00-*FF

Example

```
$PASHQ,MEM
$PASHR,MEM,0*2D
```

Relevant Set Command \$PASHS,MEM

See also \$PASHQ,FLS

MWD: Modem Watchdog Timeout

Function This command is used to query the current setting for the modem watchdog timeout.
If no data is received or sent through its port over a period of time equal to this timeout, the modem will automatically hang up.

Command Format Syntax
\$PASHQ,MWD[*cc]

Response Format Syntax

\$PASHR,MWD,d1,d2*cc

Parameters

Parameter	Description	Range	Default
d1	Current timeout setting: • 1-99: Modem timeout in minutes. • 0: No timeout	0-99	0
d2	Current idle time for modem, in minutes.	0-99	
*cc	Checksum	*00-*FF	

Example

```
$PASHQ,MWD
$PASHR,MWD,0*36
```

Relevant Set Command \$PASHS,MWD

See also \$PASHQ,MDM

NMO: NMEA Message Output Settings

Function This command is used to query the types of NMEA messages currently enabled on the specified port.

Command Format Syntax

\$PASHQ,NMO,c[*cc]

Parameters

Parameter	Description	Range
c	Queried port ID: • A: Serial port • C: Bluetooth port • E: Modem • M, U: Memory	A, C, E, M, U
*cc	Optional checksum	*00-*FF

Response Format Syntax

```
$PASHR,NMO,c1,d2,f3,d4,n(s5,f6)*cc
(n=18)
```

Parameters

Parameter	Description	Range
c1	Queried port ID: <ul style="list-style-type: none"> • A: Serial port • C: Bluetooth port • E: Modem • M, U: Memory 	A, C, E, M, U
d2	Baud rate code	0-15 (A, E) 0, 1 (C, M, U)
f3	Output rate as defined by the last \$PASHS,NME,PER command run.	0-999.0
d4	Number of NMEA messages listed in the response line	28
s5	NMEA message type	ALM, DTM, GGA, GLL, GNS, GRS, GSA, GST, GSV, HDT, RMC, VTG, ZDA, ATT, CRT, DCR, DDS, DPO, LTN, POS, RRE, SAT, SGA, SGL, SGP, VEC, XDR, PTT
f6	Output rate: <ul style="list-style-type: none"> • 0.05 or 0.1 to 0.9 or 1-999: Output rate in seconds • 0: Message disabled 	0-999.00 s
*cc	Checksum	*00-*FF

Example

\$PASHQ,NMO,A

```
$PASHR,NMO,A,6,001.00,28,ALM,0.00,DTM,0.00,GGA,0.00,GLL,0.00,GNS,
0.00,GRS,0.00,GSA,0.00,GST,0.00,GSV,0.00,HDT,0.00,RMC,0.00,VTG,0.00,
XDR,0.00,ZDA,0.00,ATT,0.00,CRT,0.00,DCR,0.00,DDS,0.00,DPO,0.00,LTN,0
.00,POS,0.00,PTT,0.00,RRE,0.00,SAT,0.00,SGA,0.00,SGL,0.00,SGP,0.00,VE
C,0.00*04
```

See also \$PASHS,NME

NPT: Tagging of SBAS Differential Positions in NMEA & NMEA-Like Messages

Function This command is used to query the receiver for the current tagging of all SBAS differential positions solutions in NMEA-like and NMEA messages the receiver generates.

Command Format Syntax

\$PASHQ,NPT[*cc]

Response Format Syntax

\$PASHR,NPT,d1,d2*cc

Parameters

Parameter	Description	Range
d1	Code assigned to SBAS differential position solution in NMEA-like messages (CRT, DCR, DPO, POS, VEC): • 0: Code "1" • 1: Code "9"	0,1
d2	Code assigned to SBAS differential position solution in NMEA messages (GGA): • 0: Code "2" • 1: Code "9"	0, 1
*cc	Optional checksum	*00-*FF

Example

```
$PASHQ,NPT
$PASHR,NPT,0,0*3E
```

Relevant Set Command \$PASHS,NPT

NTR: NTRIP Settings

Function This command is used to read the current NTRIP settings. When c6 is omitted in the query command, the returned NTRIP settings are those for the port defined through the \$PASHS,NTR,PAR command last run.

Command Format Syntax

\$PASHQ,NTR[,c6][*cc]

Response Format Syntax

\$PASHR,NTR,ADD=s1,PRT=d2,LGN=s3,PWD=s4,TYP=d5*cc

Parameters

Parameter	Description	Range
s1	Caster IP address or host name	000.000.000.000-255.255.255.255 or host name
d2	Caster port number	0-65535
s3	Login	32 characters max.
s4	Password	32 characters max.
d5	Caster type: <ul style="list-style-type: none"> • 0: Client • 1: Server 	0-1
*cc	Checksum	*00-*FF

Example

\$PASHQ,NTR

\$PASHR,NTR,ADD=192.34.76.1,PRT=2100,LGN=Ashtech,PWD=u6huz8,
TYP=0*2D

See also \$PASHS,NTR,PAR
\$PASHQ,NTR,TBL

NTR,MTP: Connection to Mount Point

Function This command is used to read the current NTRIP mount point to which the specified Internet port is connected.

Command Format **Syntax**
\$PASHQ,NTR,MTP[*cc]

Parameters

None.

Response Format **Syntax**
\$PASHR,NTR,MTP,s1*cc

Parameters

Parameter	Description	Range
s1	NTRIP mount point name If "OFF", the port is not connected to any NTRIP caster mount point.	100 characters max. or "OFF"
*cc	Checksum	*00-*FF

Example

\$PASHQ,NTR,MTP

\$PASHR,NTR,MTP,NAN2*06

Relevant Set Command \$PASHS,NTR,MTP

NTR,TBL: Source Table

Function This command is used to read the source table stored in the receiver.

Command Format Syntax
\$PASHQ,NTR,TBL[*cc]

Response Format Syntax
 \$PASHR,NTR,TBL
 SOURCETABLE 200 OK
 <source table as specified in the RTCM standard>
 ENDSOURCETABLE

Parameters

Source table as defined in the NTRIP standard.

Example

```
$PASHQ,NTR,TBL
$PASHR,NTR,TBL
SOURCETABLE 200 OK
Content-Type: text/plain
Content-Length: 7864
CAS;129.217.182.51;80;ICD;BKG;0;GER;51.5;7.5;Trial Broadcaster
NET;GREF;BKG;B;N;http://igs.ifag.deGREF.htm;none;
denise.dettmering@bkg.bund.de;none
NET;IGSIGLOS;BKG;B;N;http://igs.cb.jpl.nasa.gov/projects/rtwg
;none;denise.dettmering@bkg.bund.de;none
STR;FFMJ2;Frankfurt;RTCM2.0;1(1),3(19),16(59);0;GPS;GREF;GER;50.12;8
.68;0;1;GPSNetV1.9;none;N;N;560;DemoSTR;FFMJ1;Frankfurt;RTCM
2.1;3(19),16(59),18(1),19(1);2;GPS;GREF;GER;50.09;8.66;0;0;GPSNet
V1.9;none;N;N;2800;Demo
STR;FFMJ0;Frankfurt;RAW;Compact(1);2;GPS+GLO;IGSIGLOS;
GER;50.09;8.66;0;0;Javad Legacy E;none;N;N;3600;Demo
STR;LEIJ0;Leipzig;RAW;Compact(1);2;GPS+GLO;IGSIGLOS;
GER;51.33;12.37;0;0;Javad Legacy E;none;B;N;3600;none
STR;WTZJ0;Wetzell;RAW;Compact(1);2;GPS+GLO;IGSIGLOS;
GER;49.13;12.88;0;0;Javad Legacy E;none;B;N;3600;none
STR;HELJ0;Helgoland;RAW;Compact(1);2;GPS+GLO;IGSIGLOS;
GER;54.18;7.88;0;0;Javad Legacy E;none;B;N;3600;none
STR;TITZ0;Titz;RAW;Compact(1);2;GPS+GLO;IGSIGLOS;
```

GER;51.00;6.42;0;0;Javad Legacy E;none;B;N;3600;none
 STR;HUEG0;Huegelheim;RAW;Compact(1);2;GPS+GLO;IGSIGLOS;
 GER;47.82;7.62;0;0;Javad Legacy E;none;B;N;3600;none
 STR;DREJ0;Dresden;RAW;Compact(1);2;GPS+GLO;IGSIGLOS;
 GER;51.05;13.73;0;0;Javad Legacy E;none;B;N;3600;none
 STR;SASS0;Sassnitz;RAW;Compact(1);2;GPS+GLO;IGSIGLOS;
 GER;54.51;13.64;0;0;Javad Legacy E;none;B;N;3600;none
 STR;KARJ0;Karlsruhe;RAW;Compact(1);2;GPS+GLO;IGSIGLOS;
 GER;49.01;8.41;0;0;Javad Legacy E;none;B;N;3600;none
 STR;WILH0;Wilhelmshaven;RTCM
 2.0;1(1),3(19),16(59);0;GPS;GREF;GER;53.52;8.10;0;1;GPSNet
 V1.9;none;B;N;560;VRS
 ENDSOURCETABLE

See also \$PASHS,NTR,LOD
 \$PASHS,NTR,PAR
 \$PASHS,NTR,MTP

OCC: Occupation State and Parameters

Function This command is used to read the current occupation settings.

Command Format Syntax
\$PASHQ,OCC[*cc]

Response Format Syntax
\$PASHR,OCC,d1,d2[,s3,s4]*cc

Parameters

Parameter	Description	Range
d1	Occupation type: <ul style="list-style-type: none"> • 0: Static • 1: Quasi-static • 2: Dynamic • 4: On kinematic bar, 20 cm long 	0-2, 4
d2	Occupation state: <ul style="list-style-type: none"> • 0: Occupation in progress • 1: No occupation in progress 	0-1
s3	Occupation name	255 characters max.
s4	Occupation description	255 characters max.
*cc	Checksum	*00-*FF

Examples

\$PASHQ,OCC
\$PASHR,OCC,2,1*38

Relevant Set Command **\$PASHS,OCC**

OPTION: Installed Receiver Firmware Options

Function This command is used to list the firmware options currently installed in the receiver. The returned message includes one response line per installed option.

Command Format Syntax
\$PASHQ,OPTION[*cc]

Response Format Syntax
\$PASHR,OPTION,c1,s2,h3*cc

Parameters

Parameter	Description	Range
c1	Option ID	(See table below)
s2	Option label	
h3	Hexadecimal unlock code	13 characters max.
*cc	Checksum	*00-*FF

Option ID	Label	Description
#	REGISTRATION CODE	Registration code, depends on the firmware version, required to activate the options. Without this code, all the options below become invalid.
K	RTK	RTK processing enabled. Corrections generated in RTCM2.3, RTCM3.0, CMR or CMR+ format.
F	FASTOUTPUT	20-Hz data output rate enabled
Z	MODEM	GSM/GPRS modem enabled
S	GLONASS	GLONASS enabled
P	GNSSL2	L2 tracking enabled
M	RTK2	RTK using a proprietary data format (ATOM, DBEN or LRK) enabled. Required for a base only generating data in ATOM proprietary format.
L	RTK3	Limited RTK range enabled for a rover. Also gives full RTK capability for a base.
N	STA	RTK base enabled
O	GALILEO	Galileo tracking enabled
Q	GNSSL5	L5 tracking enabled

Example

```
$PASHQ,OPTION
$PASHR,OPTION,0,SERIAL,NUMBER,200751223*7A
```

```
$APSHR,OPTION,#,REGISTRATION CODE,057743D104182*07
$PASHR,OPTION,K,RTK,6756975c71766*36
$PASHR,OPTION,S,GLONASS,6756945714671*7B
```

If the registration code is incorrect, the command returns the following:

```
$PASHQ,OPTION
$PASHR,OPTION,0,SERIAL,NUMBER,200751223*7A
$APSHR,OPTION,#,REGISTRATION CODE,------*07
```

Relevant Set Command \$PASHS,OPTION

PAR: Receiver Parameters

Function This command lists the currently used parameters for the specified type of receiver settings. The response is returned on the port routing the query command.

Command Format **Syntax**
 \$PASHQ,PAR[,s1][*cc]

Parameters

Parameter	Description	Range
s1	Type of receiver settings. If s1 is omitted, the response lists the parameters for all types of settings, one after the other.	See table below.
*cc	Optional checksum	*00-*FF

Type	Description
STA	Status information
RCV	Receiver settings.
RTK	RTK and ARROW settings.
PRT	Port information
MEM	Memory information
SES	Session information
RXC	RINEX converter information
RDP	Radio information
MDM	Modem information
NET	Network information
XDR	External sensor information
OUT	Output information.

Response Format

Examples

\$PASHQ,PAR,STA

```

=====
STATUS INFORMATION |
-----|
STORED POSITION | 5539.380104,N,03731.554854,E,270.416 | Computed posi
COMPUTED |
DATE [dd.mm.yyyy] | 05.09.2008
UTC TIME [hhmmss.ms] | 083017.00
GPS TIME SCALE | 1495:462631000
GLO TIME SCALE | 10475:41417000
SVS TRACKED | 18 (GPS:10 SBA:2 GLO:6)
SVS USED | 13 (GPS:9 SBA:0 GLO:4) | $PASHQ,POS
SOLUTION STATUS | 0
COORDINATE SYSTEM | WGS84
=====

```

\$PASHQ,PAR,OUT

```
=====+=====
OUTPUT INFORMATION      |
-----|
```

```
RAW: -----
```

```

MPC DPC PEN SNV SAL ION SBD SNW SAW SNG SAG
A:  .05 OFF .05 001 OFF OFF ON 001 OFF 001 OFF
B:  OFF OFF OFF OFF OFF OFF OFF OFF OFF OFF OFF
C:  OFF OFF OFF OFF OFF OFF OFF OFF OFF OFF OFF
F:  OFF OFF OFF OFF OFF OFF OFF OFF OFF OFF OFF
I:  OFF OFF OFF OFF OFF OFF OFF OFF OFF OFF OFF
M:  OFF OFF OFF OFF OFF OFF OFF OFF OFF OFF OFF
R:  OFF OFF OFF OFF OFF OFF OFF OFF OFF OFF OFF
U:  OFF OFF OFF OFF OFF OFF OFF OFF OFF OFF OFF
L1: OFF OFF OFF OFF OFF OFF OFF OFF OFF OFF OFF
L2: OFF OFF OFF OFF OFF OFF OFF OFF OFF OFF OFF
L3: OFF OFF OFF OFF OFF OFF OFF OFF OFF OFF OFF
L4: OFF OFF OFF OFF OFF OFF OFF OFF OFF OFF OFF
L5: OFF OFF OFF OFF OFF OFF OFF OFF OFF OFF OFF
L6: OFF OFF OFF OFF OFF OFF OFF OFF OFF OFF OFF
L7: OFF OFF OFF OFF OFF OFF OFF OFF OFF OFF OFF
L8: OFF OFF OFF OFF OFF OFF OFF OFF OFF OFF OFF
L9: OFF OFF OFF OFF OFF OFF OFF OFF OFF OFF OFF
```

```
ATM: -----
```

```

MES PUT ATR NAV DAT EVT RMX
A:  OFF OFF OFF OFF OFF OFF OFF OFF
B:  OFF OFF OFF OFF OFF OFF OFF OFF
C:  OFF OFF OFF OFF OFF OFF OFF OFF
F:  OFF OFF OFF OFF OFF OFF OFF OFF
T:  OFF OFF OFF OFF OFF OFF OFF OFF
```

etc.

The parameters returned by \$PASHQ,PAR,OUT should be interpreted as follows:

- “OFF” means the message is currently not output.
- “ON” means it is currently output with the default output rate.
- A specified output rate means this rate has been user-set through the appropriate command.

PEM: Position Elevation Mask

Function This command is used to read the current value of the elevation mask used in the position processing.

Command Format **Syntax**
 \$PASHQ,PEM[*cc]

Response Format **Syntax**
 \$PASHR,PEM,d1*cc

Parameters

Parameter	Description	Range
d1	Elevation mask angle	0-90°
*cc	Checksum	*00-*FF

Example

```
$PASHQ,PEM
$PASHR,PEM,9*39
```

Relevant Set Command \$PASHS,PEM

See also \$PASHQ,ELM

POP: Reading Internal Update Rate

Function This command is used to read the internal update rate currently used for measurements and PVT process.

Command Format Syntax
 \$PASHQ,POP[*cc]

Parameters
 None.

Response format Syntax
 \$PASHR,POP,d*cc

Parameters

Parameter	Description	Range
d	Current update rate, in Hz. Default is 20 Hz.	10, 20
*cc	Optional checksum	*00-*FF

Example

```
$PASHQ,POP*38
$PASHR,POP,10*16
```

Relevant Set Command \$PASHS,POP

POS: Computed Position Data

Function This command allows you to query the computed position.

Command Format Syntax
`$PASHQ,POS[*cc]`

Response Format Syntax
`$PASHR,POS,d1,d2,m3,m4,c5,m6,c7,f8,f9,f10,f11,f12,f13,f14,f15,f16,s17*cc`

Parameters

Parameter	Description	Range
d1	Position mode: <ul style="list-style-type: none"> • 0: Autonomous • 1: RTCM code differential (or SBAS differential) • 2: RTK float • 3: RTK fixed • 9: SBAS Differential. See comment. 	0-3, 9
d2	Count of satellites used in position computation	3-27
m3	Current UTC time of position (hhmmss.ss)	000000.00-235959.99
m4	Latitude of position (ddmm.mmmmmm)	0-90° 00-59.999999 minutes
c5	North (N) or South (S)	N, S
m6	Longitude of position (ddmm.mmmmmm)	0-180° 00--59.999999 minutes
c7	East (E) or West (W)	E, W
f8	Altitude above the WGS84 ellipsoid	±9999.000
f9	Age of differential corrections, in seconds	0-999
f10	True Track/Course Over Ground, in degrees	0.0-359.9
f11	Speed Over Ground, in knots	0.0-999.9
f12	Vertical velocity in dm/s	±999.9
f13	PDOP	0-99.9
f14	HDOP	0-99.9
f15	VDOP	0-99.9
f16	TDOP	0-99.9
s17	Firmware version ID	4-char. string
*cc	Checksum	*00-*FF

Example

`$PASHQ,POS`

```
$PASHR,POS,3,10,151858.00,4717.960848,N,00130.499487,W,82.972,,0.0,
0.0,-0.0,2.0,1.1,1.7,1.3,G010*49
```

Comment

The code allotted to a position solution of the SBAS differential type is either “1” or “9”, depending on the last \$PASHS,NPT command run.

Relevant Set Command \$PASHS,POS

See also \$PASHS,NME
 \$PASHS,NPT

Automatic Output of POS Messages

This is a reminder on how to output POS messages at regular intervals of time: Use the \$PASHS,NME command with the syntax below:

```
$PASHS,NME,POS,<port_ID>,ON,<Rate>
```

For more details on the \$PASHS,NME command, refer to the *Set Command Library* Chapter.

As an example, the command below will output POS messages on port A at a rate of 0.2 second:

```
$PASHS,NME,POS,A,ON,0.2
```

PPS: PPS Settings

Function This command is used to read the current settings (signal period, offset and valid edge) of the PPS signal.

Command Format **Syntax**
 \$PASHQ,PPS[*cc]

Response Format **Syntax**
 \$PASHR,PPS,f1,f2,c3*cc

Parameters

Parameter	Description	Default	Range
f1	Period, in seconds	0	0.0-0.9; 1-60
f2	Offset in milliseconds	0	±999.9999
c3	Active edge: • R: Rising • F: Falling	R	R, F
*cc	Checksum		*00-*FF

Example

```
$PASHQ,PPS
$PASHR,PPS,1,500,R*5D
```

Relevant Set Command \$PASHS,PPS

PRT: Baud Rate Settings

Function This command is used to query the baud rate setting for any of the serial ports used in the receiver.

Command Format Syntax
\$PASHQ,PRT[,c1][*cc]

Parameters

Parameter	Description	Range
c1	Port ID	A, C, D, E
*cc	Optional checksum	*00-*FF

Response Format Syntax
\$PASHR,PRT,c1,d2*cc

Parameters

Parameter	Description	Range
c1	ID of port for which baud rate setting is returned.	A, C, D, E
d2	Baud rate code	0-15 (see table below)
*cc	Checksum	*00-*FF

Code	Baud Rate	Code	Baud Rate
0	300	7	38400
1	600	8	57600
2	1200	9	115200
3	2400	10	230400
4	4800	11	460800
5	9600	12	921600
6	19200	13	1428571

Example

```
$PASHQ,PRT,A
$PASHR,PRT,A,6*55
```

Relevant Set Command \$PASHS,PRT

See also \$PASHQ,CTS
\$PASHQ,MDP

PTT: PPS Time Tag

Function This command asks for the PPS time tag message to be output on the specified port, or on the port on which the query is made if no port is specified.

Command Format Syntax
\$PASHQ,PTT[,c1][*cc]

Parameters

Parameter	Description	Range
c1	Port ID	
*cc	Optional checksum	*00-*FF

Response Format Syntax
\$PASHR,PTT,d1,m2*cc

Parameters

Parameter	Description	Range
d1	Day of week: • 1: Sunday • 7: Saturday	1-7
m2	GPS time tag in hours, minutes, seconds	0-23:59:59.9999999
*cc	Checksum	*00-*FF

Example

Enabling the receiver to output the PTT message on port A:

```
$PASHS,NME,PTT,A,ON
```

Generating the PPS time tag message on port A:

```
$PASHQ,PTT,A
```

```
$PASHR,PTT,6,20:41:02.0000000*2D
```

Comments

- The response to this command will be sent out once, right after the next PPS pulse is generated.
- The response contains the GPS time at which the PPS pulse was sent, including the offset if an offset was set when the PPS pulse was enabled.
- Being set to a periodical output by the \$PASHS,NME,PTT command, this message is independent of the NMEA period. It is only linked to the PPS period.

PWR: Power Status

Function This command is used to query the power status of the receiver.

Command Format **Syntax**
\$PASHQ,PWR[*cc]

Response Format **Syntax**
\$PASHR,PWR,PAR,f1,f2,d3,[f4],[d5],[f6],[d7],d8*cc

Parameters

Parameter	Description	Range
f1	Battery voltage threshold, in volts, triggering a low-battery alarm	6.7-8.4
f2	External power voltage threshold, in volts, triggering a low-power alarm	9.0-28
d3	Power source: • 0: Internal battery • 1: External battery • 2: External DC source	0-2
f4	Battery DC output voltage, in volts	0.0-12.0
d5	Percentage of remaining battery energy	0-100
f6	DC input voltage from external power, in volts	0.0-30.0
d7	Battery charging status: • 0: Charging • 1: Discharging • 2: Fully charged	0-2
d8	Internal temperature, in °Celsius	
*cc	Checksum	*00-*FF

Comments

With no internal battery in, fields f4, d5 and d7 are all empty.
With no external power source applied, field f6 is empty.

Example

```
$PASHQ,PWR
$PASHR,PWR,6.8,9.1,2,,,11.6,,44*0D
```

Relevant Set Command \$PASHS,PWR,PAR

RAW: Raw Data Logging Settings

Function This command is used to query the raw data recording parameters.

Command Format Syntax
\$PASHQ,RAW[*cc]

Response Format Syntax
(Through an example):
PER:020.00 ELM:10
RAW: MPC DPC PBN SNV SNG SNW SAL SAG SAW ION SBD BAUD

PRTA: ON OFF OFF OFF OFF OFF OFF OFF OFF OFF OFF OFF 6
 PRTC: OFF OFF OFF OFF OFF OFF OFF OFF OFF OFF OFF OFF 1
 MEMM: OFF OFF OFF OFF OFF OFF OFF OFF OFF OFF OFF OFF 1
 MEMU: OFF OFF OFF OFF OFF OFF OFF OFF OFF OFF OFF OFF 0

Parameters

Parameter	Description	Range
PER	Output rate, in seconds	0.00-999.00
ELM	Elevation mask used in data recording & data output	0-90
RAW	Raw data type	MPC, DPC, PBN, SNV, SNG, SNW, SAL, SAG, SAW, ION, SBD
PRTA	Serial port	ON, OFF
PRTC	Bluetooth	ON, OFF
MEMM MEMU	Labels for memories M (MEMM: internal memory) and U (MEMU: USB key)	ON-OFF
BAUD	For serial port: Baud rate code For other devices, "0" if not available, else "1"	0-15 (see table below)

Code	Baud Rate	Code	Baud Rate
0	300	7	38400
1	600	8	57600
2	1200	9	115200
3	2400	10	230400
4	4800	11	460800
5	9600	12	921600
6	19200	13	1428571

Relevant Set \$PASHS,RAW
Command

RCP: Receiver Parameters

Function

Command Format **Syntax**

Parameters

Parameter	Description	Range
s1	Name of the receiver (case sensitive). If s1 is omitted, the parameters for all the receivers described in the database are listed.	31 characters max.
*cc	Checksum	*00-*FF

Response Format The response is in user-readable form.

RCP,OWN: Receiver Name

Function This command is used to read the name assigned to the receiver.

Command Format Syntax
\$PASHQ,RCP,OWN[*cc]

Parameters

None.

Response format Syntax
\$PASHR,RCP,OWN,s1*cc

Parameters

Parameter	Description	Range
s1	Receiver name	ProMark 800
*cc	Optional checksum	*00-*FF

Example

```
$PASHQ,RCP,OWN*4C
$PASHR,RCP,OWN,ProMark800*03
```

RCP,REF: Reference Receiver Name

Function This command is used to query the receiver for the name assigned locally to the base receiver from which the differential stream is received.

Command Format Syntax

\$PASHQ,RCP,REF[*cc]

Parameters

None.

Response format Syntax

\$PASHR,RCP,REF,s1,d2*cc

Parameters

Parameter	Description	Range
s1	Reference receiver name	
d2	Receiver name preference: <ul style="list-style-type: none"> • 0: s1 is ignored if the incoming reference data contain the reference receiver name • 1: s1 is always used and the decoded reference receiver name is ignored. 	0, 1
*cc	Optional checksum	*00-*FF

Example

\$PASHQ,RCP,REF*4B

\$PASHR,RCP,REF,ASHTECH,0*38

RDP,CHT: Radio Channel Table

Function This command is used to read the radio channel settings.**Command Format Syntax**

\$PASHQ,RDP,CHT,c1[*cc]

Parameters

Parameter	Description	Range
c1	Serial port used to communicate with the radio (A for external radio, D for internal radio)	A, D
*cc	Optional checksum	*00-*FF

Response Format Syntax

\$PASHR,RDP,CHT,s1,d2,n(d3,f4,f5)*cc

Or, if the channel table does not exist: \$PASHR,RDP,CHT,s1,0

(Here n=d2)

Parameters

Parameter	Description	Range
s1	Radio Model: <ul style="list-style-type: none"> • UNKNOWN: Auto-detection • NONE: No radio • PDL: Pacific Crest <ul style="list-style-type: none"> • Internal (port D): PDL RXO • External (port A): PDL HPB/LPB • ADL: Pacific Crest <ul style="list-style-type: none"> • Internal (port D): ADL RXO • External (port A): ADL Vantage • MGL: Radio transmitter P/N 800986 • MDL: U-Link • LFE: License-free radio, Europe • LFA: License-free radio, North America 	UNKNOWN, PDL, ADL, MGL, MDL, LFE, LFA, NONE
d2	Total number of available channels	0-16 (0-32 for ADL)
d3	Channel index	0-15 (1-32 for ADL)
f4	Receive frequency	410-470 MHz
f5	Transmit frequency	410-470 MHz
*cc	Checksum	*00-*FF

Comments

- Running this command should always be preceded by the execution of the \$PASHQ,RDP,PAR command, otherwise the receiver will not respond properly.
- The number of (d3,f4,f5) data sets (n) in the response line is equal to the number of channels (d2).

Examples

\$PASHQ,RDP,CHT,D

```
$PASHR,RDP,CHT,PDL,7,0,446.7750,446.7750,1,444.1000,444.1000,2,445.1000,445.1000,3,446.1000,446.1000,4,447.1000,447.1000,5,448.1000,448.1000,6,449.1000,449.1000*35
```

\$PASHQ,RDP,CHT,A

```
$PASHR,RDP,CHT,NONE,0*7B
```

See also \$PASHS,RDP,TYP
\$PASHQ,RDP, PAR

RDP,LVL: Reading the Radio Reception Level

Function This command is used to read the current level of signal at the radio receiver input. Only U-Link Rx and license-free radio receivers can return the current value of this parameter.

Command Format Syntax

```
$PASHQ,RDP,LVL,c[*cc]
```

Parameters

Parameter	Description	Range
c	Identification of the port to which the internal radio receiver is connected.	A, D
*cc	Optional checksum	*00-*FF

Response format Syntax

```
$PASHR,RDP,LVL,d1*cc
```

Parameters

Parameter	Description	Range
d1	Signal level, in dBm	
*cc	Optional checksum	*00-*FF

Example

With U-Link Rx as the internal radio connected to port D:

```
$PASHQ,RDP,LVL,D*23
$PASHR,RDP,LVL,D,-100*10
```

See Also \$PASHS,RDP,PAR
\$PASHS,RDP,TYP

RDP,PAR: Radio Parameters

Function This command allows you to query the radio settings relevant to the port used to communicate with the radio.

Command Format Syntax

```
$PASHQ,RDP,PAR,c1[*cc]
```

Parameters

Parameter	Description	Range
c1	Serial port used to communicate with the radio	A, D
*cc	Optional checksum	*00-*FF

Response Format

Syntax

```
$PASHR,RDP,PAR,c1,s2,s3,c4,s5,c6,c7,s8,f9,f10,c11,s12,s13[,f14][,c15
[,c16][,s17][,s18][,s19]*cc
```

Parameters

Parameter	Description	Range
c1	The port ID you specified in the command is replicated in this field	A, D
s2	Radio type: <ul style="list-style-type: none"> • UNKNOWN: Auto-detection • NONE: No radio • PDL: Pacific Crest <ul style="list-style-type: none"> • Internal (port D): PDL RXO • External (port A): PDL HPB/LPB • ADL: Pacific Crest <ul style="list-style-type: none"> • Internal (port D): ADL RXO • External (port A): ADL Vantage • MGL: Radio transmitter P/N 800986 • MDL: U-Link • LFE: License-free radio, Europe • LFA: License-free radio, North America 	UNKNOWN, PDL, ADL, MGL, MDL, LFE, LFA, NONE
s3	Radio state (if port D is queried)	ON, OFF
c4	Channel number	0-15 (PDL, MGL, MDL) 1-32 (ADL) 0-2 (LFE) 0-49 (LFA)
s5	Power management (if port D is queried) <ul style="list-style-type: none"> • AUT: Automatic • MAN: Manual 	AUT, MAN

Parameter	Description	Range
c6	Protocol used: PDL: <ul style="list-style-type: none"> • 0: Transparent • 1: TRIMTALK • 2: DSNP MDL: <ul style="list-style-type: none"> • 0: Transparent • 1: Not used • 2: DSNP ADL: <ul style="list-style-type: none"> • 0: Transparent (w EOT time out) • 1: TRIMTALK 450S • 2: Not used • 3: SATEL • 4: TrimMarkII/IIe • 5: TT450S (HW) • 6: TRIMMARK3 • 7: Transparent FST 	0-7
c7	Air link speed	4800, 7600, 8000, 9600, 16000, 19200
s8	Radio sensitivity (for PDL, ADL and MDL)	LOW, MED, HIGH, OFF
f9	Receive frequency, in MHz	410-470
f10	Transmit frequency, in MHz	410-470
c11	Channel spacing, in kHz: <ul style="list-style-type: none"> • PDL: 12.5 or 25 • ADL: 12.5 or 25 • MDL: 12.5 only • MGL: 12.5 only 	12.5, 25
s12	RF band, in MHz (for PDL and ADL only)	410-430, 430-450, 450-470
s13	Firmware version	
f14	Central frequency setting (MDL only)	410-470 MHz
c15	Scrambler status (PDL and ADL only): <ul style="list-style-type: none"> • 0: Off • 1: On 	0, 1
c16	Forward Error Correction status (PDL only): <ul style="list-style-type: none"> • 0: FEC Off • 1: Hamming FEC On 	0, 1
S17	RF output level (ADL and licence-free radios only): <ul style="list-style-type: none"> • LFE/LFA: 100, 200 or 500 mW, 1, 2 or 4 W • ADL: 100 or 500 mW, 1, 2 or 4 W 	100, 200 or 500 mW 1, 2 or 4 W
s18	Maximum output power (ADL only)	100 or 500 mW 1, 2 or 4 W
s18	Modulation format (PDL and ADL only)	4FSK, GMSK

Parameter	Description	Range
*cc	Checksum	*00-*FF

Examples

If an internal PDL radio receiver is used:

```
$PASHQ,RDP,PAR,D
$PASHR,RDP,PAR,D,PDL,ON,0,AUT,0,4800,MED,444.5500,446.7750,12.5,4
30-450,V02.58,,0,0*03
```

If an internal U-Link Rx is used:

```
$PASHQ,RDP,PAR,D
$PASHR,RDP,PAR,D,MDL,ON,4,AUT,0,9600,MED,447.1000,447.1000,12.5,,
V01.00,445.5500*20
```

Comments The command will be NAKed if the receiver has not been told on which port the radio is connected. This may be done using command \$PASHS,RDP,TYP.

Relevant Set Command \$PASHS,RDP,PAR

See also \$PASHS,RDP,TYP

RDP,TYP: Radio Type Used

Function This command is used to query the type of radio used on the specified port.

Command Format Syntax
\$PASHQ,RDP,TYP,c1[*cc]

Parameters

Parameter	Description	Range
c1	Serial port used to communicate with the radio	A, D
*cc	Optional checksum	*00-*FF

Response Format Syntax
\$PASHR,RDP,TYP,c1,s2*cc

Parameters

Parameter	Description	Range
c1	The port ID you specified in the command is replicated in this field	A, D
s2	Radio type: <ul style="list-style-type: none"> • UNKNOWN: Auto-detection • NONE: No radio • PDL: Pacific Crest <ul style="list-style-type: none"> • Internal (port D): PDL RXO • External (port A): PDL HPB/LPB • ADL: Pacific Crest <ul style="list-style-type: none"> • Internal (port D): ADL RXO • External (port A): ADL Vantage • MGL: Radio transmitter P/N 800986 • MDL: U-Link • LFE: License-free radio, Europe • LFA: License-free radio, North America 	UNKNOWN, PDL, ADL, MGL, MDL, LFE, LFA, NONE
*cc	Checksum	*00-*FF

Example

If an internal PDL radio receiver is used:

```
$PASHQ,RDP,TYP,D
$PASHR,RDP,TYP,D,PDL*5F
```

Relevant Set Command

```
$PASHS,RDP,TYP
```

REC: Raw Data Recording Status

Function This command allows you to read the current raw data recording status.

Command Format Syntax
\$PASHQ,REC[*cc]

Response Format Syntax
\$PASHR,REC,c*cc

Parameters

Parameter	Description	Range
c	Control character: <ul style="list-style-type: none"> • Y: Yes. Data recording in progress. Receiver will start recording data automatically when you next turn it on. • N: No. No data recording in progress. Receiver will not start recording data automatically when you next turn it on. • S: Stop. No data recording in progress but the receiver will start recording data automatically when you next turn it on. • R: Record. Data recording in progress but the receiver will not start recording data automatically when you next turn it on. 	Y, N, S, R
*cc	Checksum	*00-*FF

Example

```
$PASHQ,REC
$PASHR,REC,N*42
```

Relevant Set Command \$PASHS,REC

RID: Receiver Identification

Function This command allows you to read the receiver identification parameters.

Command Format Syntax

\$PASHQ,RID[*cc]

Response Format Syntax

\$PASHR,RID,s1,d2,s3,s4,s5,s6*cc

Parameters

Parameter	Description	Range
s1	Receiver type	PM for ProFlex 800
d2	Not used	30
s3	Firmware version	8 characters
s4	Receiver option. When an option is valid, a letter is displayed, else a dash is displayed. The options are: <ul style="list-style-type: none"> • K: RTK (Unlimited RTK) • F: FASTOUTPUT • Z: MODEM • S: GLONASS • P: GNSSL2 • M: RTK2 (RTK using proprietary formats) • L: RTK3 (Limited RTK range) • N: STA (RTK base) • O: GALILEO • Q: GNSSL5 	12 characters
s5	Not used	
s6	Serial number	9 characters
*cc	Checksum	*00-*FF

Example

\$PASHQ,RID*28

\$PASHR,RID,PM,30,S020G010,KFZS----,200751223*14

See also \$PASHQ,VERSION
\$PASHQ,OPTION

RMC: Recommended Minimum Specific GNSS Data

Function This command is used to output an RMC message containing the last computed position as well as navigation-related data.

Command Format Syntax

\$PASHQ,RMC[*cc]

Response Format Syntax

```
$GPRMC,m1,c2,m3,c4,m5,c6,f7,f8,d9,f10,c11,c12*cc
```

Parameters

Parameter	Description	Range
m1	Current UTC time of position (hhmmss.ss)	000000.00-235959.99
c2	Status <ul style="list-style-type: none"> A: Data valid V: Navigation receiver warning 	A, V
m3	Latitude of position (ddmm.mmmmmm)	0-90 0-59.999999
c4	Direction of latitude	N, S
m5	Longitude of position (dddmm.mmmmmm)	0-180 0-59.999999
c6	Direction of longitude	E,W
f7	Speed Over Ground, in knots	000.0-999.9
f8	Course Over Ground, in degrees (true)	000.0-359.9
d9	Date (ddmmyy)	010100-311299
f10	Magnetic variation, in degrees	0.00-99.9
c11	Direction of variation	E, W
c12	Mode indicator: <ul style="list-style-type: none"> A: Autonomous mode D: Differential mode N: Data not valid 	A, D, N
*cc	Checksum	*00-*FF

Example

```
$PASHQ,RMC
```

```
$GPRMC,160324.50,A,4717.959275,N,00130.500805,W,0.0,0.0,250208,1.9,W,A*3D
```

See also

```
$PASHS,NME
```

Automatic Output of RMC Messages

This is a reminder on how to output RMC messages at regular intervals of time: Use the \$PASHS,NME command with the syntax below:

```
$PASHS,NME,RMC,<port_ID>,ON,<Rate>
```

For more details on the \$PASHS,NME command, refer to the *Set Command Library* Chapter.

As an example, the command below will output RMC messages on port A at a rate of 0.5 second:

```
$PASHS,NME,RMC,A,ON,0.5
```

RNX,MSI: ATOM RNX Differential Message

Function This command allows you to read the current settings of the ATOM RNX message.

Command Format Syntax
\$PASHQ,RNX,MSI[*cc]

Parameters
 None.

Response Format Syntax
\$PASHR,RNX,MSI,d1,d2,d3*cc

Parameters

Parameter	Description	Range
d1	Scenario number	0-4, 101, 201-204, 300
d2	Output rate for observations, in seconds.	0.1-0.4 if [F] option activated. 0.5-0.9 1-1800
d3	Output rate for attributes (receiver and antenna names), in seconds.	0:Disabled 1-1800
*cc	Checksum	*00-*FF

Example

\$PASHQ,RNX,MSI
\$PASHR,RNX,MSI,4,1.0,31*7E

Relevant Set Command **\$PASHS,RNX,TYP**

RRE: Residual Error

Function This command is used to output a range residual message. The message is not output until a position solution is computed.

Command Format Syntax
\$PASHQ,RRE[*cc]

Response Format Syntax

```
$PASHR,RRE,d1,n(d2,f3),f4,f5*cc
```

Parameters

Parameter	Description	Range
d1	Number of satellites used to compute the position	3-27
d2	Satellite number	GPS: 1-32 SBAS: 33-64 GLONASS: 65-96
f3	Range residual	±999.9 m
f4	RMS horizontal position error	0-9999.9 m
f5	RMS vertical position error	0-9999.9 m
*cc	Checksum	*00-*FF

Example

```
$PASHQ,RRE
```

```
$PASHR,RRE,12,20,0.5,13,0.4,23,-0.4,17,-0.6,25,-0.3,04,-0.1,02,0.5,77,  
-0.0,84,0.0,83,0.0,78,0.0,68,0.1,1.2,2.3*34
```

See also \$PASHS,NME

RTC: RTCM Status

Function This command queries the current status of the RTCM. The return message is in free-form format.

Command Format Syntax

```
$PASHQ,RTC[*cc]
```

Response Format Syntax

(Through an example)

```
STATUS:  
SYNC:* VER:V2.3 STID:0000 STHE:0  
AGE:+0000 TYPE:18/19  
MSG:  
SETUP:  
MODE:BAS PORT:A,E VER:V3,V2.3  
STI:0000  
TYP: 1 3 9 16 18 19 20 21 22  
FRQ: 0 30 0 1 1 0 0 30  
TYP: 23 24 31 32 34 36  
FRQ: 0 0 0 0 0  
TYP: 1001 1002 1003 1004 1005 1006 1007 1008
```

FRQ: 0 0 0 1 0 30 0 0
 TYP: 1009 1010 1011 1012 1013 1019 1020 1029 1033
 FRQ: 0 0 0 1 30 0 0 0 31
 MSG:
 MSG:No User Message

Parameters

Status:

Parameter	Description	Range
SYNC	RTCM status: <ul style="list-style-type: none"> *: Corrections from base received in rover in due time. <space>: No corrections are received that would be compatible with the "maximum age of corrections" requirement. 	*, <space>
VER	RTCM version	V2.3, V3
STID	Station ID received from the base	0-4095
STHE	Station health index received from the base	0-7 (RTCM2.3)
AGE	Age of last message received	0-999
TYPE	RTCM message being received or sent	1, 18/19, 20/21, 31, 1001, 1002, 1003, 1004, 1009, 1010, 1011, 1012
MSG	User message received in message type 16, 36 or 1029	90 characters max.

Setup:

Parameter	Description	Range
MODE	RTCM Base/Rover mode: <ul style="list-style-type: none"> ROV: If the receiver is a rover. BAS: If the receiver is a base and the selected differential data type is RT2 or RT3. 	ROV, BAS, OFF
PORT	Communication port: <ul style="list-style-type: none"> AUT, in rover mode, when the differential reception mode is "AUT" (see \$PASHS,CPD,REM). One or two ports, in rover mode, when the differential reception mode is "MAN" (see \$PASHS,CPD,REM) One or two ports, in base mode (see \$PASHS,BAS). Only if RT2 or RT3 is used. 	
VER	RTCM version	V2.3, V3
STI	Station ID	0-4095
TYP	Type of RTCM message the receiver generates (base receiver only)	
FRQ	Transmit rate of RTCM message, in seconds	0-1800

Parameter	Description	Range
MSG	User message sent through message type 16, 36 or 1029	90 characters max.

See also \$PASHS,RTC,TYP
\$PASHS,BAS
\$PASHS,CPD,REM

RTC,MSI: RTCM Message Status

Function This command queries a base receiver for the current RTCM message status.

Command Format **Syntax**
\$PASHQ,RTC,MSI[*cc]

Response Format **Syntax**
\$PASHR,RTC,MSI,d1,n(d2,d3)*cc

Parameters

Parameter	Description	Range
d1	Number of RTCM message types in the RTCM output message	32
d2	RTCM message type	1, 3, 9, 16, 18-24, 31, 32, 34, 1001-1013, 1019, 1020, 1029, 1033
d3	Message output rate in seconds	0-1800
*cc	Checksum	*00-*FF

Example \$PASHQ,RTC,MSI
\$PASHR,RTC,MSI,32,1,0,0,3,30,0,9,0,0,16,0,0,18,1,0,19,1,0,20,0,0,21,0,0,22,30,0,23,0,0,24,0,0,31,0,0,32,0,0,34,0,0,36,0,0,1001,0,0,1002,0,0,1003,0,0,1004,1,0,1005,0,0,1006,13,0,1007,0,0,1008,0,0,1009,0,0,1010,0,0,1011,0,0,1012,1,0,1013,0,0,1019,0,0,1020,0,0,1029,0,0,1033,31,0*5C

See also \$PASHS,RTC,TYP

RWO: Raw Data Output Settings

Function This command is used to query the raw data output parameters on the specified port.

Command Format Syntax

```
$PASHQ,RWO,c[*cc]
```

Parameters

Parameter	Description	Range
c	Port ID the command refers to	A, C, M, U
*cc	Optional checksum	*00-*FF

Response Format Syntax

```
$PASHR,RWO,c1,d2,f3,d4,n(s5,f6,c7)*cc
```

Where n=8

Parameters

Parameter	Description	Range
c1	The port ID specified in the command is reminded in this field: <ul style="list-style-type: none"> A: Serial port C: Bluetooth port M, U: Memory 	A, C, M, U
d2	Baud rate code for serial port. For other devices, "0" if not available, else "1"	0-9 (A). See table below 0-1 (C, M, U)
f3	Output rate defined by the last \$PASHS,RAW,PER command run	0-999.9
d4	Number of raw data messages	11
s5	Raw data message types	MPC, DPC, PBN, SNV, SNG, SNW, SAL, SAG, SAW, ION, SBD
f6	Output rate 0: Message disabled	0-999.00
c7	ASCII/Binary setting. Always binary	B
*cc	Checksum	*00-*FF

Code	Baud Rate	Code	Baud Rate
0	300	5	9600
1	600	6	19200
2	1200	7	38400
3	2400	8	57600

Code	Baud Rate	Code	Baud Rate
4	4800	9	115200

Example

\$PASHQ,RWO,A

\$PASHR,RWO,A,9,001.00,11,MPC,0.00,B,DPC,0.00,B,PBN,0.00,B,SNV,0.00
 ,B,SNG,0.00,B,SNW,0.00,B,SAL,0.00,B,SAG,0.00,B,SAW,0.00,B,ION,0.00,B,
 SBD,0.00,B *6D

See also \$PASHQ,RAW

SAT: Satellites Status

Function This command allows you to read the status of the different satellite constellations used.

Command Format **Syntax**
 \$PASHQ,SAT[*cc]

Response Format **Syntax**
 \$PASHR,SAT,d1,n(d2,d3,d4,f5,c6)*cc

Parameters

Parameter	Description	Range
d1	Number of satellites locked	
d2	SV PRN number	1-32: GPS 33-64: SBAS 65-96: GLONASS GALILEO: 97-126 GIOVE A/B: 127-128
d3	SV azimuth, in degrees	0-359
d4	SV elevation angle, in degrees	0-90
f5	SV signal-noise ratio, in dB.Hz	30.0-60.0
c6	SV used in computation or not <ul style="list-style-type: none"> • U: SV used • -: SV not used 	
*cc	Checksum	*00-*FF

The GPS PRN number is d2.

The EGNOS PRN number is d2 plus 87.

The GLONASS slot number is d2 minus 64.

The GALILEO PRN number is d2 minus 96.

Example**\$PASHQ,SAT**

```
$PASHR,SAT,13,20,092,32,44.0,U,13,206,78,50.0,U,23,056,55,48.0,U,33,19
8,34,44.0,-,17,218,13,42.0,U,25,152,34,38.0,U,04,276,65,50.0,U,02,308,31,
48.0,U,77,052,37,48.0,U,84,294,33,48.0,U,83,234,23,48.0,U,78,124,42,46.0,
U,68,034,65,48.0,U*35
```

Automatic Output of SAT Messages

This is a reminder on how to output SAT messages at regular intervals of time: Use the \$PASHS,NME command with the syntax below:

```
$PASHS,NME,SAT,<port_ID>,ON,<Rate>
```

For more details on the \$PASHS,NME command, refer to the *Set Command Library* Chapter.

As an example, the command below will output SAT messages on port A at a rate of 60 seconds:

```
$PASHS,NME,SAT,A,ON,60
```

SBA: SBAS Tracking Status

Function This command is used to query the SBAS tracking status.

Command Format **Syntax**

```
$PASHQ,SBA[*cc]
```

Response Format **Syntax**

```
$PASHR,SBA,s*cc
```

Parameters

Parameter	Description	Range
s	ON: SBAS satellites are being tracked and used OFF: SBAS satellites not tracked	ON, OFF
*cc	Checksum	*00-*FF

Example**\$PASHQ,SBA**

```
$PASHR,SBA,ON*09
```

Relevant Set Command \$PASHS,SBA

SGA: GALILEO Satellites Status

Function This command is used to read the status of each GALILEO satellite received.

Command Format Syntax
\$PASHQ,SGA[*cc]

Response Format Syntax
\$PASHR,SGA,d1,n(d2,d3,d4,f5,,f7,d8,d9)*cc

Parameters

Parameter	Description	Range
d1	Number of satellites locked	1-27
d2	SV PRN number (96+satellite slot number)	97-126 127-128: GIOVE-A/B
d3	SV azimuth in degrees	0-359
d4	SV elevation angle in degrees	0-90
f5	SV E1 signal/noise in dB.Hz	30.0-60.0
f6	Not used	-
f7	SV E5a signal/noise in dB.Hz	30.0-60.0
d8	Satellite usage status (see table below)	0-31
d9	Satellite correcting status (see table below)	0-15
*cc	Checksum	*00-*FF

Fields f5 and f7 are empty if the corresponding signal is not tracked.

Satellite Usage Status:

Status	Description
0	Satellite not tracked
1	Code and carrier/Doppler data used
2	Code-only data used
3	Carrier/Doppler-only data used
4-14	Reserved
15	Unknown usage status
16	No navigation data for this satellite
17	Satellite below elevation mask
18	Satellite declared as unhealthy in ephemeris
19	Computed coordinates of satellite are invalid
20	Satellite has been disabled by a \$PASH command
21	URA in ephemeris is not acceptable
22	SV is unhealthy according to almanac

Status	Description
23	Too low SNR
24	Suspected of being a ghost satellite
25	Because of too many Satellites used in the PVT, this satellite has been deselected
26-30	Reserved for future causes of rejection
31	Other cause

Satellite Correcting Status:

Status	Description
0	Satellite is not tracked
1	Satellite is not corrected
2	SBAS is corrected
3	DGPS is corrected
4	L1 RTK is corrected
5	L1&L2 RTK is corrected
6-14	Reserved
15	Unknown correcting status

Example

\$PASHQ,SGA

\$PASHR,SGA,2,128,092,32,44.0,,35.0,2,4,...

See also

\$PASHS,NME

Automatic Output of SGA Messages

This is a reminder on how to output SGA messages at regular intervals of time: Use the \$PASHS,NME command with the syntax below:

\$PASHS,NME,SGA,<port_ID>,ON,<Rate>

For more details on the \$PASHS,NME command, refer to the *Set Command Library* Chapter.

As an example, the command below will output SGA messages on port A at a rate of 10 seconds:

\$PASHS,NME,SGA,A,ON,10

SGL: GLONASS Satellites Status

Function

This command is used to read the status of each GLONASS satellite received.

Command Format Syntax

\$PASHQ,SGL[*cc]

Response Format Syntax

\$PASHR,SGL,d1,n(d2,d3,d4,f5,f6,,d8,d9)*cc

Parameters

Parameter	Description	Range
d1	Number of satellites locked	1-27
d2	SV PRN number (64+satellite slot number)	65-96
d3	SV azimuth in degrees	0-359
d4	SV elevation angle in degrees	0-90
f5	SV L1 signal/noise in dB.Hz	30.0-60.0
f6	SV L2 signal/noise in dB.Hz	30.0-60.0
f7	Not used	
d8	Satellite usage status (see table below)	0-31
d9	Satellite correcting status (see table below)	0-15
*cc	Checksum	*00-*FF

Fields f5 and f6 are empty if the corresponding signal is not tracked.

Satellite Usage Status:

Status	Description
0	Satellite not tracked
1	Code and carrier/Doppler data used
2	Code-only data used
3	Carrier/Doppler-only data used
4-14	Reserved
15	Unknown usage status
16	No navigation data for this satellite
17	Satellite below elevation mask
18	Satellite declared as unhealthy in ephemeris
19	Computed coordinates of satellite are invalid
20	Satellite has been disabled by a \$PASH command
21	URA in ephemeris is not acceptable
22	SV is unhealthy according to almanac
23	Too low SNR
24	Suspected of being a ghost satellite
25	Because of too many Satellites used in the PVT, this satellite has been deselected
26-30	Reserved for future causes of rejection
31	Other cause

Satellite Correcting Status:

Status	
0	Satellite is not tracked
1	Satellite is not corrected
2	SBAS is corrected
3	DGPS is corrected
4	L1 RTK is corrected
5	L1&L2 RTK is corrected
6-14	Reserved
15	Unknown correcting status

Example**\$PASHQ,SGL**

```
$PASHR,SGL,08,65,316,38,49.0,38.0,,01,15,71,122,32,47.0,39.0,,01,15,72.0,
66,77,53.0,48.0,,01,15,73,036,31,48.0,43.0,,01,15,74,100,75,52.0,41.0,,01,1
5,75,192,34,45.0,36.0,,01,15,81,332,13,40.0,33.0,,01,15,88,282,08,37.0,32.0
,,25,15*0D
```

See also

\$PASHS,NME

Automatic Output of SGL Messages

This is a reminder on how to output SGL messages at regular intervals of time: Use the \$PASHS,NME command with the syntax below:

```
$PASHS,NME,SGL,<port_ID>,ON,<Rate>
```

For more details on the \$PASHS,NME command, refer to the *Set Command Library* Chapter.

As an example, the command below will output SGL messages on port A at a rate of 10 seconds:

```
$PASHS,NME,SGL,A,ON,10
```

SGP: GPS & SBAS Satellites Status

Function

This command is used to read the status of each GPS and SBAS satellite received.

Command Format**Syntax**

```
$PASHQ,SGP[*cc]
```

Response Format**Syntax**

```
$PASHR,SGP,d1,n(d2,d3,d4,f5,f6,f7,d8,d9)*cc
```

Parameters

Parameter	Description	Range
d1	Number of satellites locked	1-27
d2	SV PRN number (64+satellite slot number)	GPS: 1-32 SBAS: 33-64
d3	SV azimuth in degrees	0-359
d4	SV elevation angle in degrees	0-90
f5	SV L1 signal/noise in dB.Hz	30.0-60.0
f6	SV L2 signal/noise in dB.Hz	30.0-60.0
f7	SV L5 signal/noise in dB.Hz	30.0-60.0
d8	Satellite usage status (see table below)	0-31
d9	Satellite correcting status (see table below)	0-15
*cc	Checksum	*00.*FF

Fields f5-f7 are empty if the corresponding signal is not tracked.

Satellite Usage Status:

Status	Description
0	Satellite not tracked
1	Code and carrier/Doppler data used
2	Code-only data used
3	Carrier/Doppler-only data used
4-14	Reserved
15	Unknown usage status
16	No navigation data for this satellite
17	Satellite below elevation mask
18	Satellite declared as unhealthy in ephemeris
19	Computed coordinates of satellite are invalid
20	Satellite has been disabled by a \$PASH command
21	URA in ephemeris is not acceptable
22	SV is unhealthy according to almanac
23	Too low SNR
24	Suspected of being a ghost satellite
25	Because of too many Satellites used in the PVT, this satellite has been deselected
26-30	Reserved for future causes of rejection
31	Other cause

Satellite Correcting Status:

Status	Description
0	Satellite is not tracked
1	Satellite is not corrected
2	SBAS is corrected
3	DGPS is corrected

Status	
4	L1 RTK is corrected
5	L1&L2 RTK is corrected
6-14	Reserved
15	Unknown correcting status

Example**\$PASHQ,SGP**

```
$PASHR,SGP,13,02,216,22,42.0,25.0,,01,15,04,188,03,34,0,0,0,,17,15,05,28
4,71,51.0,44.0,,01,15,07,058,50,50,0,39.0,,01,15,08,116,77,51.0,41.0,,01,15,
10,148,53,50,0,38.0,,01,15,13,080,13,38,0,15.0,,25,15,15,272,03,37.0,0,0,,1
7,15,21,332,04,37.0,0,0,,17,15,26,276,39,47.0,33.0,,01,15,28,142,20,41.0,20
.0,,01,15,33,200,34,41.0,,,16,15,39,146,32,41.0,,,16,15*16
```

See also

\$PASHS,NME

**Automatic Output
of SGP Messages**

This is a reminder on how to output SGP messages at regular intervals of time: Use the \$PASHS,NME command with the syntax below:

```
$PASHS,NME,SGP,<port_ID>,ON,<Rate>
```

For more details on the \$PASHS,NME command, refer to the *Set Command Library* Chapter.

As an example, the command below will output SGP messages on port A at a rate of 10 seconds:

```
$PASHS,NME,SGP,A,ON,10
```

SIT: Site Name

Function

This command is used to read the name of the site on which data is currently being logged.

Command Format**Syntax**

```
$PASHQ,SIT[*cc]
```

Response Format**Syntax**

```
$PASHR,SIT,s*cc
```

Parameters

Parameter	Description	Range
s	Site name	4 characters max.

Parameter	Description	Range
*cc	Checksum	*00-*FF

Example

```
$PASHQ,SIT
$PASHR,SIT,SITE*1D
```

Relevant Set Command \$PASHS,SIT

See also \$PASHQ,FLS

SNM: Signal-to-Noise Ratio Mask

Function This command returns the current value assigned to the signal-to-noise ratio (SNR) mask. Any satellite received with an SNR value for the C/A code signal less than this mask will be rejected from the PVT computation.

Command Format Syntax
\$PASHQ,SNM[*cc]

Parameters

None.

Response Format Syntax
\$PASHR,SNM,d1*cc

Parameters

Parameter	Description	Range
d1	Signal-to-Noise ratio mask, in dB.Hz	0-60
*cc	Checksum	*00-*FF

Example **\$PASHQ,SNM**
\$PASHR,SNM,45*09

Relevant Set Command \$PASHS,SNM

SOM: Signal Observations Masking

Function This command is used to read the type of mask currently applied to signal observations.

Command Format Syntax
\$PASHQ,SOM[*cc]

Parameters
 None.

Response Format Syntax
\$PASHR,SOM,d*cc

Parameters

Parameter	Description	Range
s	Mask type: <ul style="list-style-type: none"> • 0: No masking • 1: Reference station • 2: Static base • 3: Moving base • 4: Rover • 9: User-defined 	0-4, 9
*cc	Checksum	*00-*FF

Example

```
$PASHQ,SOM
$PASHR,SOM,4*3D
```

Relevant Set Command \$PASHS,SOM

SOM,CTT: Cumulative Tracking Time Mask

Function This command is used to read the current setting of the cumulative tracking time mask applied to signal observations. This mask is active only when applying masks to signal observations has been set to be user defined (see \$PASHS,SOM).

Command Format Syntax
 \$PASHQ,SOM,CTT[*cc]

Parameters

None.

Response Format Syntax
 \$PASHR,SOM,CTT,d1,d2*cc

Parameters

Parameter	Description	Range	Default
d1	Mask applied to differential data, in seconds	0-255	10
d2	Mask applied to raw data, in seconds	0-255	10
*cc	Checksum	*00-FF	

Example

\$PASHQ,SOM,CTT
 \$PASHR,SOM,CTT,10*67

Relevant Set Command \$PASHS,SOM,CTT

See Also \$PASHS,SOM

SOM,NAV: Navigation Data Mask

Function This command is used to read the current setting of the navigation data mask applied to signal observations. This mask is active only when applying masks to signal observations has been set to be user defined (see \$PASHS,SOM).

Command Format Syntax
 \$PASHQ,SOM,NAV[*cc]

Parameters

None.

Response Format Syntax
 \$PASHR,SOM,NAV,s1,s2*cc

Parameters

Parameter	Description	Range	Default
s1	Mask applied to differential data	ON, OFF	ON
s2	Mask applied to raw data	ON, OFF	OFF
*cc	Checksum	*00-*FF	

Example

```
$PASHQ,SOM,NAV
$PASHR,SOM,NAV,ON,ON*50
```

Relevant Set Command \$PASHS,SOM,NAV

See Also \$PASHS,SOM

SOM,SNR: Signal-to-Noise Ratio Mask

Function This command is used to read the current setting of the signal-to-noise ratio mask applied to signal observations. This mask is active only when applying masks to signal observations has been set to be user defined (see \$PASHS,SOM).

Command Format Syntax
\$PASHQ,SOM,SNR[*cc]

Parameters

None.

Response Format Syntax
\$PASHR,SOM,SNR,d1,d2*cc

Parameters

Parameter	Description	Range	Default
d1	Mask applied to differential data, in dBHz	0-60	28
d2	Mask applied to raw data, in dBHz	0-60	28
*cc	Checksum	*00-*FF	

Example

```
$PASHQ,SOM,SNR
$PASHR,SOM,SNR,28,28*46
```

Relevant Set Command \$PASHS,SOM,SNR

See Also \$PASHS,SOM

SOM,WRN: Channel Warnings Mask

Function This command is used to read the current setting of the channel warnings mask applied to signal observations. This mask is active only when applying masks to signal observations has been set to be user defined (see \$PASHS,SOM).

Command Format Syntax
 \$PASHQ,SOM,WRN[*cc]

Parameters

None.

Response Format Syntax
 \$PASHR,SOM,WRN,s1,s2*cc

Parameters

Parameter	Description	Range	Default
s1	Mask applied to differential data	ON, OFF	ON
s2	Mask applied to raw data	ON, OFF	OFF
*cc	Checksum	*00-*FF	

Example

\$PASHQ,SOM,WRN
 \$PASHR,SOM,WRN,ON,ON*42

Relevant Set Command \$PASHS,SOM,WRN

See Also \$PASHS,SOM

STI: Station ID

Function This command is used to query the receiver for the station ID it transmits to the rover through the corrections message.

Command Format Syntax
\$PASHQ,STI[*cc]

Response Format Syntax
\$PASHR,STI,d*cc

Parameters

Parameter	Description	Range
d	Station ID	0-1023 (RTCM 2.3) 0-4095 (RTCM 3.x) 0-31 (CMR & CMR+)
*cc	Checksum	*00-*FF

Example

```
$PASHQ,STI
$PASHR,STI,817*28
```

Relevant Set Command \$PASHS,STI

SVM: Satellite Use Mask

Function This command is used to read the current setting of the satellite use mask defining the maximum number of code or Doppler observations used in the PVT calculation.

Command Format Syntax
\$PASHQ,SVM[*cc]

Parameters

None.

Response Format Syntax
\$PASHR,SVM,d1*cc

Parameters

Parameter	Description	Range	Default
d1	Maximum number of code/Doppler observations used in PVT.	0-26	14
*cc	Checksum	*00-*FF	*00-*FF

Example

```
$PASHQ,SVM
$PASHR,SVM,25*17
```

Relevant Set Command \$PASHS,SVM

UDP: User-Defined Dynamic Model

Function This command is used to query the parameters of the user-defined dynamic model.

Command Format Syntax
 \$PASHQ,UDP[*cc]

Response Format Syntax
 \$PASHR,UDP,f1,f2,f3,f4*cc

Parameters

Parameter	Description	Range	Default
f1	Maximum expected horizontal velocity, in m/s	0-100 000	100 000
f2	Maximum expected horizontal acceleration, in m/s ²	0-100	100
f3	Maximum expected vertical velocity, in m/s	0-100 000	100 000
f4	Maximum expected vertical acceleration, in m/s ²	0-100	100
*cc	Checksum	*00-*FF	

Example

```
$PASHQ,UDP
$PASHR,UDP,100000.00,100.00,100000.00,100.00*35
```

Relevant Set Command \$PASHS,UDP

See Also \$PASHS,DYN

UNT: Distance Unit Used on Display Screen

Function This command allows you to know which distance unit is currently used on the receiver display screen to express the coordinates of the computed position.

Command Format Syntax
\$PASHQ,UNT[*cc]

Response Format Syntax
\$PASHR,UNT,s*cc

Parameters

Parameter	Description	Range
s	Distance unit used: <ul style="list-style-type: none"> • M: Meters • F: US Survey Feet • IF: International Feet 	M, F, IF
*cc	Checksum	*00-*FF

Example

```
$PASHQ,UNT
$PASHR,UNT,M*5A
```

Relevant Set Command \$PASHS,UNT

UTS: GPS Time Synchronization Status

Function This command gives the status of the GPS time synchronization process. When enabled, this process allows all measurements and coordinates to be synchronized with GPS time, and not with the local clock.

Command Format Syntax
\$PASHQ,UTS[*cc]

Response Format Syntax
\$PASHR,UTS,s*cc

Parameters

Parameter	Description	Range
s	GPS time synchronization status	ON, OFF
*cc	Checksum	*00-*FF

Example

\$PASHQ,UTS
\$PASHR,UTS,ON*0B

Relevant Set Command \$PASHS,UTS

VEC: Vector & Accuracy Data

Function This command is used to query the receiver for vector and accuracy data.

Command Format Syntax
\$PASHQ,VEC[*cc]

Response Format Syntax
\$PASHR,VEC,c1,d2,m3,f4,f5,f6,f7,f8,f9,f10,f11,f12,d13*cc

Parameters

Parameter	Description	Range
c1	Position mode: <ul style="list-style-type: none"> • 0: Autonomous • 1: RTCM (or SBAS Differential) • 2: RTK float • 3: RTK fixed • 9: SBAS Differential. See comment. 	0-3, 9
d2	Number of SVs used in position computation	3-27
m3	UTC time (hhmmss.ss)	000000.00-235959.99
f4	X component of vector (along ECEF X axis), in meters	±99999.999
f5	Y component of vector (along ECEF Y axis), in meters	±99999.999
f6	Z component of vector (along ECEF Z axis), in meters	±9999.999
f7	X component standard deviation	99.999
f8	Y component standard deviation	99.999
f9	Z component standard deviation	99.999
f10	XY correlation	±9.999999
f11	XZ correlation	±9.999999
f12	YZ correlation	±9.999999
d13	Base station ID (RTCM only)	0-4095
^cc	Checksum	*00-*FF

Example

\$PASHQ,VEC

```
$PASHR,VEC,3,09,130924.00,-37.683,55.081,-17.925,0.016,0.012,0.026,
0.234765,0.098765,0.098763,0001*71
```

Comment

The code allotted to a position solution of the SBAS differential type is either “1” or “9”, depending on the last \$PASHS,NPT command run.

See Also

\$PASHS,NME

\$PASHS,NPT

Automatic Output of VEC Messages

This is a reminder on how to output VEC messages at regular intervals of time: Use the \$PASHS,NME command with the syntax below:

```
$PASHS,NME,VEC,<port_ID>,ON,<Rate>
```

For more details on the \$PASHS,NME command, refer to the *Set Command Library* Chapter.

As an example, the command below will output VEC messages on port A at a rate of 0.2 second:

```
$PASHS,NME,VEC,A,ON,0.2
```

VERSION: Firmware Version

Function This command is used to list the firmware versions installed in the receiver, including those of the modem and internal radio.

Command Format **Syntax**
\$PASHQ,VERSION[*cc]

Response Format **Syntax**
 (Through an example)
\$PASHQ,VERSION
 \$PASHQ,VERSION
 RECEIVER VERSION: V1.0-S717Kt24
 SYS fw: S112
 GNSS fw: Kt24
 KERNEL: 2.6.19-pm4 #204 Fri Apr 3 14:29:24
 RESCUE: 2.6.19-rescue
 BOOT LOADER: 1.1.5.9
 PMU: 2.31.0
 API: 1.222
 BSP: 1.0-200
 GNSS S/N: 702465A011230172
 GNSS Options: WJKLEYGSVHCPIQFAOD
 RFS: 717
 GSM Q26 Extreme: R.7.4 IMEI : 351919030190256 stack IP : WIP Soft v540
 on Open AT OS v634
 Internal Radio: ADL V03.02(2250)

Comments In the GSM: information line, the GSM version will appear only after the modem has been turned on. The stack IP version will appear only after a GPRS connection has been established.

See also \$PASHQ,RID

VTG: Course Over Ground and Ground Speed

Function This command is used to output a VTG message.

Command Format Syntax
\$PASHQ,VTG[*cc]

Response Format Syntax
\$GPVTG,f1,T,f2,M,f3,N,f4,K,c5*cc

Parameters

Parameter	Description	Range
f1,T	COG (with respect to True North) T for "True" North: COG orientation	000.00-359.99
f2,M	COG (with respect to Magnetic North) M for "Magnetic" North: COG orientation	000.00-359.99
f3,N	SOG (Speed Over Ground) N for "knots": SOG unit	000.00-999.99
f4,K	SOG (Speed Over Ground) K for "km/hr": SOG unit	000.00-999.99
c5	Mode indicator: • A: Autonomous mode • D: Differential mode • N: Data not valid	A, D, N
*cc	Checksum	*00-*FF

Comments The magnetic table used is the WMM-2005 (published Dec 2004), which is the standard model of the US Department of Defense (WMM for "World Magnetic Model").

Example **\$PASHQ,VTG**
\$GPVTG,128.00,T,129.92,M,0.17,N,0.31,K,A*2D

Automatic Output of VTG Messages This is a reminder on how to output VTG messages at regular intervals of time: Use the \$PASHS,NME command with the syntax below:

\$PASHS,NME,VTG,<port_ID>,ON,<Rate>

For more details on the \$PASHS,NME command, refer to the *Set Command Library* Chapter.

As an example, the command below will output VTG messages on port A at a rate of 0.5 second:

\$PASHS,NME,VTG,A,ON,0.5

WARN: Warning Messages

Function This command is used to list the possible warning messages stored in the receiver.

Command Format Syntax
 \$PASHQ,WARN[*cc]

Response Format Syntax
 \$PASHR,WARN,s1,s2*cc

Parameters

Parameter	Description	Range
s1	Warning message label NONE: No warning message	See <i>List of Alarms on page 99</i> .
s2	Status: <ul style="list-style-type: none"> • Pending: Alarm acknowledged • Current: Alarm not acknowledged yet • Occurred: An error condition was detected earlier but has vanished since then 	PENDING, CURRENT, OCCURRED
*cc	Checksum	*00-*FF

Example \$PASHQ,WARN
 \$PASHR,WARN,connect. to GPRS failed,PENDING*7F

See also \$PASHS,WAK

ZDA: Time & Date

Function This command returns the receiver date & time.

Command Format Syntax
 \$PASHQ,ZDA[*cc]

Response Format Syntax
 \$GPZDA,ZDA,m1,d2,d3,d4,d5,d6*cc

Parameters

Parameter	Description	Range
m1	UTC time (hhmmss.ss)	000000.00-235959.99
d2	Current day	01-31
d3	Current month	01-12
d4	Current year	0000-9999
d5	Local zone offset from UTC time (hour)	-13 to +13
d6	Local zone offset from UTC time (minutes)	00-59
*cc	Checksum	*00-*FF

Example

\$PASHQ,ZDA

\$GPZDA,162256.27,25,02,2008,+00,00*43

NOTE: The time offset is always reported as null (d5= d6= 0).

Automatic Output of ZDA Messages

This is a reminder on how to output ZDA messages at regular intervals of time: Use the \$PASHS,NME command with the syntax below:

\$PASHS,NME,ZDA,<port_ID>,ON,<Rate>

For more details on the \$PASHS,NME command, refer to the *Set Command Library* Chapter.

As an example, the command below will output ZDA messages on port A at a rate of 60 seconds:

\$PASHS,NME,ZDA,A,ON,60

Appendix D. Output Message Library

ION: Ionosphere Parameters

This message contains the ionosphere and GPS-to-UTC data conversion parameters.

The message is as follows:

```
$PASHR,ION,<structure>
```

The message's binary structure is described in the table below.

Type	Name	Size	Contents
Float	a0	4	Ionospheric parameter (seconds)
Float	a1	4	Ionospheric parameter (seconds/semi-circle)
Float	a2	4	Ionospheric parameter (seconds/semi-circle)
Float	a3	4	Ionospheric parameter (seconds/semi-circle)
Float	b0	4	Ionospheric parameter (seconds)
Float	b1	4	Ionospheric parameter (seconds/semi-circle)
Float	b2	4	Ionospheric parameter (seconds/semi-circle)
Float	b3	4	Ionospheric parameter (seconds/semi-circle)
Double	A1	8	First order terms of polynomial
Double	A0	8	Constant terms of polynomial
Unsigned long	Tot	4	Reference time for UTC data
Short	Wnt	4	UTC reference week number
Short	DtLS	2	GPS-UTC differences at reference time
Short	WnLSF	2	Week number when leap second became effective
Short	DN	2	Day number when leap second became effective
Short	DtLSF	2	Delta time between GPS and UTC after correction
Short	Wn	2	GPS week number
Unsigned long	Tow	4	Time of the week (in seconds)
Short	bulwn	2	GPS week number when message was read
Unsigned long	bultow	4	Time of the week when message was read

Type	Name	Size	Contents
Unsigned short	Check-sum	2	The checksum is computed by breaking the structure into 37 unsigned shorts, adding them together, and taking the least significant 16 bits of the result.
Total		76	

The GPS broadcast ionosphere model (Klobuchar) is used.

Reminder on How to Output ION Messages

Use the \$PASHS,RAW command with the syntax below:

```
$PASHS,RAW,ION,<port_ID>,ON,<Rate>
```

For more details on the \$PASHS,RAW command, refer to the *Set Command Library* Chapter.

As an example, the command below will output ION messages on port A at a rate of 5 seconds:

```
$PASHS,RAW,ION,A,ON,5
```

MPC: GNSS Measurements

This message contains the measurement of one satellite for one epoch.

The message is as follows:

```
$PASHR,MPC,<structure>
```

The message's binary structure is described in the table below.

Type	Size	Contents
Unsigned short	2	Sequence tag (unit: 50 ms) modulo 30 minutes
Unsigned char	1	Number of remaining structure to be sent for current epoch
Unsigned char	1	Satellite index number GPS: 1-32 SBAS: 33-51 GLONASS: 65-88
Unsigned char	1	Satellite elevation angle (degree)
Unsigned char	1	Satellite azimuth angle (2-degree increments)
Unsigned char	1	Channel ID not duplicated for the current epoch
	29	C/A code data block (29 bytes)
Unsigned char	1	Warning flag Bit1, Bit2: 0,0: Code and/or carrier phase measured but measurement was not used to compute position. 1,0: Code and/or carrier phase measured, navigation message was obtained and measurement was used to compute position but position wasn't finally computed. 0,1: Code and/or carrier phase measured, navigation message was obtained, measurement was used to compute position and position was computed successfully. Bit3: Carrier phase questionable Bit4: Code phase (range) questionable Bit5: Range not precise (code phase loop not settled) Bit6: Z tracking mode Bit7: Possible cycle slip Bit8: Loss of lock since last epoch

Type	Size	Contents
Unsigned char	1	Indicates quality of the position measurement (good/bad) 0: Measurement not available and no additional data will be sent. 23: Code and/or carrier phase measured, navigation message was obtained and measurement was used to compute position but position wasn't finally computed. 24: Code and/or carrier phase measured, navigation message was obtained, measurement was used to compute position and position was computed successfully. Other state: measurement was not used to compute position.
Unsigned char	1	Polarity of the phase tracking 0: Polarity unknown 5: Polarity known
Unsigned char	1	Signal-to-noise ratio for satellite observation (db.Hz)
Unsigned char	1	Always 0. Not used.
Double	8	Full carrier phase measurements in cycles
Double	8	Raw range to SV (in seconds), i.e. receive time - raw range = transit time
Long	4	Doppler (10^{-4} Hz)
Long	4	Smoothing Bits 0-22: magnitude of smooth correction in centimeters Bit 23: sign of smooth correction Bits 24-31: smooth count, unsigned, as follows: 0=unsmoothed 1=least smoothed 255=most smoothed
	29	L1 block , same format as C/A code data block (see note below)
	29	L2 block , same format as C/A code data block (see note below)
Unsigned char	1	Checksum, a bitwise exclusive OR (XOR)
Total of bytes	95	

NOTES:

- The sequence tag for GLONASS satellites is x seconds less than the sequence tag for GPS satellites, due to the difference between the UTC (used for GLONASS) and GPS system time scales.
- The raw range for GLONASS satellites contains a time shift of x seconds, i.e. x seconds more than for GPS

satellites in the same conditions. “x” is as defined in the previous note.

- In case of GPS L1/L2P tracking mode, the **L1 block** contains L1P data. In case of GPS L2CS tracking mode, the **L1 block** contains zero data. In case of GLONASS-M satellites, the **L1 block** contains zero data.
- In case of GPS L1/L2P, the **L2 block** contains L2P data. In case of GPS L2CS tracking mode, the **L2 block** contains L2CS data. In case of GLONASS-M satellites, the **L2 block** contains C/A data on the L2 frequency

Reminder on How to Output MPC Messages

Use the \$PASHS,RAW command with the syntax below:

```
$PASHS,RAW,MPC,<port_ID>,ON,<Rate>
```

For more details on the \$PASHS,RAW command, refer to the *Set Command Library* Chapter.

As an example, the command below will output MPC messages on port A at a rate of 1 second:

```
$PASHS,RAW,MPC,A,ON,1
```

DPC: Compact GPS Measurements

This message contains the L1/L2 measurements from all tracked GPS satellites for one epoch.

The message is as follows:

```
$PASHR,DPC,<structure>
```

The message's binary structure is described in the table below.

Type*	Size in bits	Resolution	Contents
Unsigned short	16		Message length. Number of bytes in the <packed data> section.
PACKED DATA			
Double	32	1 msec	Receiver time in GPS milliseconds of week
Char[4]	32		Receiver's four-character ID
Unsigned long	32		Mask representing satellites that are contributors to the message content. This is a bitwise indication: Starting from the least significant bit, bit1 corresponds to SV PRN#1, bit2 corresponds to SV PRN#2, and so on. Bit value "1" for a given SV PRN means the corresponding satellite is a data contributor to this message, "0" otherwise.
The data that follow are repeated for each satellite presented in the satellite mask			
Unsigned char	1		Satellite health ("0" means Sat is unhealthy)
Unsigned char	7	1 degree	Satellite elevation
Unsigned char	1		RAIM status (always zero)
Unsigned char	7	1 dBHz	SNR of L1CA observation
#L1 Data Block (L1CA in all cases)			
Double	31	0.1 nsec	Raw range in 0.1 nsec (range is smoothed by carrier). "0" means bad raw range data.
Unsigned char	1		Warning flag ("1" means bad carrier phase with possible cycle slips)
Unsigned char	1		Sign of total carrier phase ("1": negative; "0":positive)
Double	28	1 cycle	Integer part of total carrier phase in cycles
Double	11	0.0005 cycles	Fractional part of phase in 0.0005 cycles
Double	24	0.002 Hz	Doppler in units of 0.002 Hz
#L2 Data Block (L2P for CFG,2&4 and L2C for CFG,3&5)			
Content and data packing scheme is the same as for L1 Data			
CHECKSUM			
Unsigned short	16		Cumulative unsigned short sum of the <packed data>, after <message length> and before <checksum>

The data in this message are packed in bits rather than bytes. So the presented types of fields are just for the sake of giving a meaningful description of the original data packing.

NOTES:

- Most of the fields found in the DPC and DBEN data outputs are similar.
- DPC data are affected by the last \$PASHS,UTS command run. By default, this command is set to “ON”.
- DPC data are affected by the last \$PASHS,ANP,OUT command run.
- DPC data can be made available on several ports simultaneously.
- DPC data can be output at a rate of up to 20 Hz, but the throughput compared to RTCM-3, CMR and ATOM may be quite higher.
- DPC data are not considered to be used as a differential protocol, i.e. they are simply generated, and so not processed to become corrections.

Reminder on How to Output DPC Messages

Use the \$PASHS,RAW command with the syntax below:

```
$PASHS,RAW,DPC,<port_ID>,ON,<Rate>
```

For more details on the \$PASHS,RAW command, refer to the *Set Command Library* Chapter.

As an example, the command below will output DPC messages on port A at a rate of 1 second:

```
$PASHS,RAW,DPC,A,ON,1
```

PBN: Position Information

This message contains position information in binary format.

The message is as follows:

```
$PASHR,PBN,<structure>
```

The message's binary structure is described in the table below.

Type	Name	Size	Contents
Long	pbentime	4	GPS time when data was received (ms of week)
Char	sitename	4	Site name
Double	navx	8	Station position: ECEF-X (m)
Double	navy	8	Station position: ECEF-Y (m)
Double	navz	8	Station position: ECEF-Z (m)
Float	navt	4	Clock offset (m)
Float	navxdot	4	Velocity in ECEF-X (m/s)
Float	navydot	4	Velocity in ECEF-Y (m/s)
Float	navzdot	4	Velocity in ECEF-Z (m/s)
Float	navtdot	4	Clock drift (m/s)
Unsigned short	pdop	2	PDOP multiplied by 100
Unsigned short	checksum	2	The checksum is computed by breaking the structure into 27 unsigned shorts, adding them together, and taking the least significant 16 bits of the result.
Total of bytes		56	

When for example after a cold start, the receiver has no correct time tag, the PBN message is output with a fixed "zero" time tag.

Unlike all the other position messages, the position provided in a PBN message *cannot* be an RTK position. It can only be a standalone, SBAS or DGNSS position.

Reminder on How to Output PBN Messages

Use the \$PASHS,RAW command with the syntax below:

```
$PASHS,RAW,PBN,<port_ID>,ON,<Rate>
```

For more details on the \$PASHS,RAW command, refer to the *Set Command Library* Chapter.

As an example, the command below will output PBN messages on port A at a rate of 1 second:

```
$PASHS,RAW,PBN,A,ON,1
```

SBA,DAT: SBAS Data Message

Provided the command below has been run beforehand,
\$PASHS,RAW,SBD,<port_ID>,ON

... the SBA,DAT message is output in response to:
\$PASHQ,SBD, <port_ID>

...and is in the form:
\$PASHR,SBA,DAT,d1,m2,d3,d4,s5*cc

Where:

Parameter	Description	Range
d1	SBAS SV ID number	33-51
m2	Time tag: hhhmss.hh The SBA,DAT message contains the time tag of the beginning of WAAS message transmission (WAAS message transmission time is 1 second)	000000.00-235959.99
d3	RTCA message ID	0-63
d4	Error flags (in HEX): bit0-preamble error, bit1-parity error	0-2
s5	RTCA message: 250 bit in 63 HEX numbers. The data lie from left to right and from high-order to low-order bits. The two low-order bits in the 63rd number are not used.	
*cc	Checksum, computed by "exclusive-ORing" all of the bytes in the message between, but not including, the "\$" and the "**". The result is "*cc" where c is a hexadecimal character.	*00-*FF

SAL: GPS Almanac Data

This message contains almanac data for one GPS satellite. The message is as follows:

```
$PASHR,SAL,<structure>
```

The message's binary structure is described in the table below.

Type	Name	Size	Contents
Short	prn	2	Satellite PRN number minus 1 (0-31)
Short	health	2	Satellite health
Float	e	4	Eccentricity
Long	toe	4	Reference time for orbit (sec)
Float	i0	4	Inclination angle at reference time (semi-circles)
Float	w dot	4	Rate of right ascension (semi-circles/sec)
Double	A1/2	8	Square root of semi-major axis (meters ^{1/2})
Double	w0	8	Longitude of ascending node (semicircles)
Double	w	8	Argument of perigee (semicircles)
Double	M0	8	Mean anomaly at reference time (semi-circle)
Float	Af0	4	Clock correction (sec)
Float	Af1	4	Clock correction (sec/sec)
Short	wna	2	Almanac week number
Short	wn	2	GPS week number
Long		4	Seconds of GPS week
Unsigned short	Checksum	2	The checksum is computed by breaking the structure into 34 unsigned shorts, adding them together, and taking the least significant 16 bits of the result.
Total		70	

Reminder on How to Output SAL Messages

Use the \$PASHS,RAW command with the syntax below:

```
$PASHS,RAW,SAL,<port_ID>,ON,<Rate>
```

For more details on the \$PASHS,RAW command, refer to the *Set Command Library* Chapter.

As an example, the command below will output SAL messages on port A at a rate of 15 seconds:

```
$PASHS,RAW,SAL,A,ON,15
```

SAG: GLONASS Almanac Data

This message contains almanac data for one GLONASS satellite.

The message is as follows:

```
$PASHR,SAG,<structure>
```

The message's binary structure is described in the table below.

Type	Name	Size	Contents
Short	prn	2	Satellite number 1-24
Short	frq	2	Satellite GLONASS frequency number [-7,...,6]
Short	health	2	Satellite health 0=bad, 1=good
Float	e	4	Eccentricity
Long		4	Reference day number (days in range 1 to 1461)
Float		4	Correction to inclination (semicircles)
Float	w0	4	Longitude of first ascending node (semicircles)
Float		4	Reference time of longitude of first node (seconds)
w	Float	4	Argument of perigee (semicircles)
Float	Af0	4	Correction to mean value (43200 s) of Draconic period
Float	Af1	4	$Af1=d(Af0)/dt(sec/sec)$
Float		4	Satellite clock offset (seconds)
Unsigned short	Checksum	2	The checksum is computed by breaking the structure into 21 unsigned shorts, adding them together, and taking the least significant 16 bits of the result.
Total		44	

Reminder on How to Output SAG Messages

Use the \$PASHS,RAW command with the syntax below:

```
$PASHS,RAW,SAG,<port_ID>,ON,<Rate>
```

For more details on the \$PASHS,RAW command, refer to the *Set Command Library* Chapter.

As an example, the command below will output SAG messages on port A at a rate of 15 seconds:

```
$PASHS,RAW,SAG,A,ON,15
```

SAW: SBAS Almanac Data

This message contains almanac data for one SBAS satellite.
The message is as follows:

```
$PASHR,SAW,<structure>
```

The message's binary structure is described in the table below.

Type	Name	Size	Contents
char	Id	1	Data ID
char	Health	1	Satellite Health&Status bitwise meaning is: Bit0 – Ranging On(0), Off(1) Bit1 – Corrections On(0), Off(1) Bit2 – Broadcast Integrity On(0), Off(1) Bit3 – Reserved Bit4-7 – SBAS provider ID (0-15): 0 – WAAS, 1 – EGNOS, 2 – MSAS, 3-13 – Not assigned yet, 14-15 – Reserved
long	T0	4	Almanac data reference time within the day expressed in the SBAS time scale (seconds)
float		3*4	Satellite ECEF X,Y,Z coordinates (meters)
float		3*4	Satellite ECEF velocity X', Y', Z' coordinates (m/s)
long	Tow	4	Time within week in GPS time scale when SBAS almanac was received
char	Wn	1	Week number in GPS time scale modulo 256 when SBAS almanac was received
char	Prn	1	Satellite number (33 to 51)
Unsigned short	Check-sum	2	The checksum is computed by breaking the structure into 18 unsigned shorts, adding them together, and taking the least significant 16 bits of the result.
Total		38	

Reminder on How to Output SAW Messages

Use the \$PASHS,RAW command with the syntax below:

```
$PASHS,RAW,SAW,<port_ID>,<ON>,<Rate>
```

For more details on the \$PASHS,RAW command, refer to the *Set Command Library* Chapter.

As an example, the command below will output SAW messages on port A at a rate of 15 seconds:

\$PASHS,RAW,SAW,A,ON,15

SNG: GLONASS Ephemeris Data

This message contains the GLONASS ephemeris data for one satellite.

The message is as follows:

```
$PASHR,SNG,<structure>
```

The message's binary structure is described in the table below.

Type	Name	Size	Contents
Long		4	Start time of 30-second frame in satellite time scale t_k from which the ephemeris data is derived; time modulo one day (seconds)
Short		2	Day number of 30-second frame; modulo four-year period counting from beginning of last leap year, which corresponds to parameter t_b (t_b is set within this day number). This parameter varies within the range 1 to 1461. If day number=0, the day number is unknown (absent in navigation frame)
Long		4	Ephemeris data reference time within the day expressed in GLONASS system time scale = UTC + 3 hours (seconds)
Float		4	Frequency offset g_h of the on-board frequency standard at t_b (dimensionless)
Float		4	Bias t_n between satellite time scale and GLONASS system time scale at t_b (seconds)
Double		3*8	Satellite ECEF (PZ-90) X, Y, Z coordinates (km)
Float		3*4	Satellite ECEF (PZ-90) velocity X', Y', Z' (km/sec)
Float		3*4	Satellite perturbation acceleration X'', Y'', Z'' due to moon and sun (km/sec/sec).
Double		8	Bias between GLONASS system time scale and UTC + 3 hours time scale t_c (seconds)
Char		1	Age of ephemeris parameter E_n (interval from moment when ephemeris data was last uploaded to t_b)
Char		1	Combined 3-bit flag (contains I1, I2, I3)
Char		1	Satellite health status flag (0=good, 1=bad)
Char		1	Satellite frequency channel number [-7,...,6]
Short		2	Satellite system number (satellite number [1,...,24])

Type	Name	Size	Contents
Unsigned short	Check-sum	2	The checksum is computed by breaking the structure into 40 unsigned shorts, adding them together, and taking the least significant 16 bits of the result.
Total		82	

Reminder on How to Output SNG Messages

Use the \$PASHS,RAW command with the syntax below:

```
$PASHS,RAW,SNG,<port_ID>,ON,<Rate>
```

For more details on the \$PASHS,RAW command, refer to the *Set Command Library* Chapter.

As an example, the command below will output SNG messages on port A at a rate of 15 seconds:

```
$PASHS,RAW,SNG,A,ON,15
```

SNV: GPS Ephemeris Data

This message contains the GPS ephemeris data for one satellite.

The message is as follows:

```
$PASHR,SNV,<structure>
```

The message's binary structure is described in the table below.

Type	Name	Size	Contents
Short	Wn	2	GPS week number
Long	Two	4	Seconds in GPS week
Float	Tgd	4	Group delay (sec)
Long	Aodc	4	Clock data issue
Long	Toc	4	Clock data reference time (sec)
Float	af2	4	Clock correction (sec/sec ²)
Float	af1	4	Clock correction (sec/sec)
Float	af0	4	Clock correction (sec)
Long	Aode	4	Orbit data issue
Float	Dn	4	Mean anomaly correction (semicircles/sec)
Double	M0	8	Mean anomaly at reference time (semicircles)
Double	e	8	Eccentricity
Double	A ^{1/2}	8	Square root of semi-major axis (meters ^{1/2})
Long	toe	4	Reference time for orbit (sec)
Float	cic	4	Harmonic correction term (radians)
Float	crc	4	Harmonic correction term (meters)
Float	cis	4	Harmonic correction term (radians)
Float	crs	4	Harmonic correction term (meters)
Float	cuc	4	Harmonic correction term (radians)
Float	cus	4	Harmonic correction term (meters)
Double	omega0	8	Longitude of ascending node (semicircles)
Double	omega	8	Argument of perigee (semicircles)
Double	i0	8	Inclination angle (semicircles)
Float	omega dot	4	Rate of right ascension (semicircles/sec)
Float	i dot	4	Rate of inclination (semicircles/sec)
Short	Accuracy	2	User range accuracy
Short	Health	2	Satellite health
Short	fit	2	Curve fit interval
Char	prn	1	Satellite PRN number minus 1 (0-31)
Char		1	Reserved byte

Type	Name	Size	Contents
Unsigned short	Checksum	2	The checksum is computed by breaking the structure into 37 unsigned shorts, adding them together, and taking the least significant 16 bits of the result.
Total		76	

Reminder on How to Output SNV Messages

Use the \$PASHS,RAW command with the syntax below:

```
$PASHS,RAW,SNV,<port_ID>,ON,<Rate>
```

For more details on the \$PASHS,RAW command, refer to the *Set Command Library* Chapter.

As an example, the command below will output SNV messages on port A at a rate of 15 seconds:

```
$PASHS,RAW,SNV,A,ON,15
```

SNW: SBAS Ephemeris Data

This message contains the SBAS ephemeris data for one satellite.

The message is as follows:

```
$PASHR,SNW,<structure>
```

The message's binary structure is described in the table below.

Type	Name	Size	Contents
char	-	1	Spare field
char	accuracy	1	Accuracy
long	T0	4	Ephemeris data reference time within the day expressed in the SBAS time scale (seconds)
double		3*8	Satellite ECEF X,Y,Z coordinates (meters)
float		3*4	Satellite ECEF velocity X', Y', Z' coordinates (m/s)
float		3*4	Satellite ECEF acceleration X'',Y'',Z'' (m/s ²)
float	aGf0	4	Time offset between satellite time scale and SBAS system time scale (seconds)
float	aGf1	4	Time drift between satellite time scale and SBAS system time scale (seconds)
long	tow	4	Time within week in GPS time scale when SBAS ephemeris was received
char	wn	1	Week number in GPS time scale when SBAS ephemeris was received
char	prn	1	Satellite number (33 to 51)
Unsigned short	Checksum	2	The checksum is computed by breaking the structure into 34 unsigned shorts, adding them together, and taking the least significant 16 bits of the result.
Total		70	

Reminder on How to Output SNW Messages

Use the \$PASHS,RAW command with the syntax below:

```
$PASHS,RAW,SNW,<port_ID>,ON,<Rate>
```

For more details on the \$PASHS,RAW command, refer to the *Set Command Library* Chapter.

As an example, the command below will output SNW messages on port A at a rate of 15 seconds:

```
$PASHS,RAW,SNW,A,ON,15
```

Symbols

\$PASHQ,AGB 261
 \$PASHQ,ALM 262
 \$PASHQ,ANH 263
 \$PASHQ,ANP 264
 \$PASHQ,ANP,OUT 265
 \$PASHQ,ANP,OWN 265
 \$PASHQ,ANP,RCV 266
 \$PASHQ,ANP,REF 267
 \$PASHQ,ANR 267
 \$PASHQ,ANT 268
 \$PASHQ,ATL 269
 \$PASHQ,ATM 271
 \$PASHQ,ATO 272
 \$PASHQ,BAS 273
 \$PASHQ,BEEP 275
 \$PASHQ,BRD 276
 \$PASHQ,BTH 276
 \$PASHQ,CFG 277
 \$PASHQ,CMR,MSI 278
 \$PASHQ,CPD,AFP 279
 \$PASHQ,CPD,ANT 280
 \$PASHQ,CPD,FST 281
 \$PASHQ,CPD,MOD 281
 \$PASHQ,CPD,NET 282
 \$PASHQ,CPD,POS 283
 \$PASHQ,CPD,REM 285
 \$PASHQ,CPD,VRS 286
 \$PASHQ,CRT 287
 \$PASHQ,CTS 288
 \$PASHQ,DBN,MSI 289
 \$PASHQ,DCR 290
 \$PASHQ,DDS 291
 \$PASHQ,DIP 292
 \$PASHQ,DPO 294
 \$PASHQ,DRI 295
 \$PASHQ,DSY 296
 \$PASHQ,DTM 297
 \$PASHQ,DYN 299
 \$PASHQ,ELM 300
 \$PASHQ,FIL,CUR 300
 \$PASHQ,FIL,LST 301
 \$PASHQ,FLS 302
 \$PASHQ,GAL 303
 \$PASHQ,GGA 304
 \$PASHQ,GLL 305
 \$PASHQ,GLO 307
 \$PASHQ,GNS 307
 \$PASHQ,GPS 309
 \$PASHQ,GRS 311
 \$PASHQ,GSA 312
 \$PASHQ,GST 314
 \$PASHQ,GSV 316
 \$PASHQ,LCS 317
 \$PASHQ,LOG 319
 \$PASHQ,LOG,LST 320
 \$PASHQ,LOG,PAR 320
 \$PASHQ,MDM 321
 \$PASHQ,MDM,LVL 323
 \$PASHQ,MDM,STS 323
 \$PASHQ,MDP 324
 \$PASHQ,MEM 325
 \$PASHQ,MWD 325
 \$PASHQ,NMO 326
 \$PASHQ,NPT 327
 \$PASHQ,NTR 328
 \$PASHQ,NTR,MTP 329
 \$PASHQ,NTR,TBL 330
 \$PASHQ,OCC 332
 \$PASHQ,OPTION 333
 \$PASHQ,PAR 334
 \$PASHQ,POP 337
 \$PASHQ,POS 338
 \$PASHQ,PPS 339
 \$PASHQ,PRT 340
 \$PASHQ,PTT 341
 \$PASHQ,PWR 342
 \$PASHQ,RAW 343
 \$PASHQ,RCP,OWN 345
 \$PASHQ,RCP,REF 345
 \$PASHQ,RDP,CHT 346
 \$PASHQ,RDP,LVL 348
 \$PASHQ,RDP,PAR 348
 \$PASHQ,RDP,TYP 351
 \$PASHQ,REC 353
 \$PASHQ,RID 353
 \$PASHQ,RNX,MSI 356
 \$PASHQ,RRE 356
 \$PASHQ,RTC 357
 \$PASHQ,RTC,MSI 359
 \$PASHQ,RWO 360
 \$PASHQ,SAT 361
 \$PASHQ,SBA 362
 \$PASHQ,SGA 363
 \$PASHQ,SGL 364
 \$PASHQ,SGP 366
 \$PASHQ,SIT 368
 \$PASHQ,SNM 369
 \$PASHQ,SOM 370
 \$PASHQ,SOM,CTT 370
 \$PASHQ,SOM,NAV 371
 \$PASHQ,SOM,SNR 372
 \$PASHQ,SOM,SVM 374

\$PASHQ,SOM,WRN 373
\$PASHQ,STI 374
\$PASHQ,UDP 375
\$PASHQ,UNT 376
\$PASHQ,UTS 376
\$PASHQ,VEC 377
\$PASHQ,VERSION 379
\$PASHQ,VTG 380
\$PASHQ,WARN 381
\$PASHQ,ZDA 381
\$PASHR,DPC 388
\$PASHR,ION 383
\$PASHR,MPC 385
\$PASHR,PBN 390
\$PASHR,SAG 393
\$PASHR,SAL 392
\$PASHR,SAW 395
\$PASHR,SNG 397
\$PASHR,SNV 399
\$PASHR,SNW 401
\$PASHS,AGB 153
\$PASHS,ANH 154
\$PASHS,ANP,DEL 155
\$PASHS,ANP,EDx 154
\$PASHS,ANP,OUT 156
\$PASHS,ANP,PCO 154
\$PASHS,ANP,REF 157
\$PASHS,ANR 158
\$PASHS,ANT 159
\$PASHS,ATL 162
\$PASHS,ATM 163
\$PASHS,ATM,ALL 165
\$PASHS,ATM,PER 166
\$PASHS,ATM,VER 167
\$PASHS,BAS 167
\$PASHS,BEEP 169
\$PASHS,BRD 169
\$PASHS,BTH,NAME 173
\$PASHS,BTH,PIN 173
\$PASHS,CFG 174
\$PASHS,CMD,LOD 146, 176
\$PASHS,CMD,WTI 177
\$PASHS,CMR,TYP 178
\$PASHS,CPD,AFP 179
\$PASHS,CPD,FST 180
\$PASHS,CPD,MOD 180
\$PASHS,CPD,NET 182
\$PASHS,CPD,REM 183
\$PASHS,CPD,RST 184
\$PASHS,CPD,VRS 185
\$PASHS,CTS 186
\$PASHS,DBN,TYP 186

\$PASHS,DIP 187
\$PASHS,DIP,OFF 188
\$PASHS,DIP,ON 189
\$PASHS,DIP,PAR 189
\$PASHS,DRI 190
\$PASHS,DSY 191
\$PASHS,DYN 192
\$PASHS,ELM 193
\$PASHS,FIL,D 194
\$PASHS,FIL,DEL 195
\$PASHS,GAL 196
\$PASHS,GLO 197
\$PASHS,GPS 198
\$PASHS,INI 200
\$PASHS,LCS 122, 201
\$PASHS,LOG,DEL 202
\$PASHS,LOG,PAR 203
\$PASHS,LTZ 203
\$PASHS,MDM,INI 204
\$PASHS,MDM,OFF 205
\$PASHS,MDM,ON 205
\$PASHS,MDM,PAR 206
\$PASHS,MDP 207
\$PASHS,MEM 208
\$PASHS,MWD 209
\$PASHS,NME 209
\$PASHS,NME,ALL 211
\$PASHS,NME,PER 212
\$PASHS,NPT 213
\$PASHS,NTR,LOD 214
\$PASHS,NTR,MTP 215
\$PASHS,NTR,PAR 216
\$PASHS,OCC 217
\$PASHS,OPTION 218
\$PASHS,PAR,LOD 219
\$PASHS,PAR,SAV 220
\$PASHS,PEM 222
\$PASHS,POP 222
\$PASHS,PPS 224
\$PASHS,PRT 225
\$PASHS,PWR,OFF 226
\$PASHS,PWR,PAR 226
\$PASHS,RAW 227
\$PASHS,RAW,ALL 229
\$PASHS,RAW,PER 230
\$PASHS,RCP,DEL 232
\$PASHS,RCP,GBx 231
\$PASHS,RCP,REF 233
\$PASHS,RDP,OFF 234
\$PASHS,RDP,ON 234
\$PASHS,RDP,PAR 235
\$PASHS,RDP,TYP 239

\$PASHS,REC 240
\$PASHS,RNX,TYP 242
\$PASHS,RST 243
\$PASHS,RTC,MSG 244
\$PASHS,RTC,TYP 245
\$PASHS,SBA 247
\$PASHS,SIT 247
\$PASHS,SNM 248
\$PASHS,SOM 248
\$PASHS,SOM,CTT 250
\$PASHS,SOM,NAV 251
\$PASHS,SOM,SNR 252
\$PASHS,SOM,WRN 254
\$PASHS,STI 255
\$PASHS,UDP 257
\$PASHS,UNT 257
\$PASHS,UTS 258
\$PASHS,WAK 259
\$PASHS,ZDA 260

A

Absolute positioning 54
Absolute, centimeter-accurate positioning 54
AC/DC power supply kit 2
Accuracy 18, 72
ACK 144
Acknowledge alarms 259
Acknowledge (alarm) 99
Acquisition/re-acquisition of GNSS signals 18
Adaptive 192, 299
Adjusting GLONASS biases 153
AGB 153, 261
Age of corrections 79, 88
Alarm status 11
Alarms 6, 99, 259
ALM 210, 262
Almanac 262
Ambiguity 279
Ambiguity fixing process 179
ANH 154, 263
ANP 264
ANP,DEL 155
ANP,EDx 154
ANP,OUT 156, 265
ANP,OWN 265
ANP,PCO 154
ANP,RCV 266
ANP,REF 157, 267
ANR 158, 267
ANT 159, 268

Antenna characteristics 8
Antenna definitions 154
Antenna extension 2
Antenna height 154, 263, 268
Antenna height (base) 280
Antenna name and status of received base 266
Antenna parameters 138, 264
Antenna reduction 267
Antenna reduction mode 158
Antenna used at the base 267
ARP 63, 158, 159
Ashtech (legacy format) 227
ATL 114, 269
ATL command 162
ATL file 162
ATM 163, 193, 271
ATM,ALL 165
ATM,PER 166
ATM,VER 167
ATO 272
ATOM 18
ATOM data parameters 271
ATOM files 117
ATOM format 89
ATOM message parameters 272
ATOM messages 163
ATOM messages (output rate) 166
ATOM messages (version) 167
ATOM RNX differential message 242, 356
ATOM version 117
AUTO 10
Auto Dial 85
autoconfig.cmd file 146
autoconfig.log file 147

B

Background map 130
Backlight 6
Backup mode 182
Backup RTK 182
BAS 167, 273
BASE 10
Base antenna (naming) 157
Base data 41
Base location 52
Base position 54, 283
Base settings 139
Base/rover configuration 40
Base/rover mode 180, 281
Baseline 40, 46, 290
Battery 20

- Battery (external) 30
- Battery (insert) 17
- Battery (remove) 15
- Battery charger 2
- Battery icon 11
- Battery kit 20
- Battery model 7
- Baud rate 340
- BEEP 169, 275
- Beeper setup 169
- Biases 231
- BLADE 1, 40
- Bluetooth 8, 136
- Bluetooth device name 173
- Bluetooth identifier 13
- Bluetooth pin code 173
- Bluetooth settings 276
- Bluetooth status 11
- BPW 131
- BRD 169, 276
- BTH 276
- BTH,NAME 173
- BTH,PIN 173
- Buzzer 6
- C**
- Can't fix.. 109
- Carlson Image X-Port.exe 130
- Carrier 39
- Carrier cycle 72
- Carrier phase measurements 39
- Carrying case 4
- Cartesian coordinates 290
- Caster IP address 216
- CDMA 79, 84
- Cell phone 79, 83
- Centimeter-level accuracy 95
- CEP 75
- CFG 174, 277
- Channel spacing 82
- Channel warnings mask 373
- Channel warnings masks 254
- Channels 17
- Charging battery 16
- CMD,LOD 176
- CMD,WTI 177
- CMR 18, 90, 193
- CMR message type and rate 178
- CMR, CMR+ 167
- CMR,MSI 278
- CMR,TYP 178
- CMR+ 90, 193
- Command window 145
- Computed position 338
- Confidence level 179
- Configuring the receiver from a PAR file 219
- Constellation 41
- Copy user data to USB key 121
- Course over ground 380
- CPD 40
- CPD,AFP 179, 279
- CPD,ANT 280
- CPD,FST 281
- CPD,MOD 180, 281
- CPD,NET 182, 282
- CPD,POS 283
- CPD,REM 183, 285
- CPD,RST 184
- CPD,VRS 185, 286
- CRT 287
- CSD 79, 85
- CTS 186, 288
- CTT 248
- Cumulative tracking time mask 370
- Cumulative tracking time masks 250
- D**
- Daisy chain 191, 296
- Data formats 18
- Data link 41, 79, 106
- Data link (monitoring) 87
- Data link icon 10
- Data logging 105
- Data transfer screen 15, 37
- Date & time 260
- Datum Reference 297
- DBEN 18, 89
- DBEN message status 289
- DBEN messages (generating) 186
- DBN,MSI 289
- DBN,TYP 186
- DC power input 7
- DCR 290
- DDS 291
- Debug data 162
- Debug data recording 269
- Default settings 136
- Deleting files 194
- Deleting files and directories 195
- Deleting log files 202
- Deleting user-defined receiver name 232
- Delta position 294
- Device cable (USB) 2, 37
- Differential data port 183, 285

Differential data type *167, 273*
Differential decoder status *291*
DIP *187, 292*
DIP,OFF *188*
DIP,ON *189*
DIP,PAR *189*
Direct IP *79, 84, 87, 292*
Direct IP connection *188, 189*
Direct IP parameters *189*
Disabling all ATOM messages *165*
Disabling all raw data messages *229*
Display screen *5*
Distance mode *52*
Distance unit on display screen *376*
Distance unit used on display screen *257*
DOP *55, 112*
DPC *388*
DPO *294*
DRI *190, 295*
DSY *191, 296*
DTM *297*
Duty cycle *82*
DYN *192, 299*
Dynamics *192, 257*

E

ECEF *70*
ECEF coordinates *287*
EDGE *20*
Editing a log file *319*
Elevation *70*
Elevation mask *193, 222*
Elevation mask (position) *336*
Ellipsoidal height *70*
ELM *193, 300*
Enable/disable Galileo *196*
Enable/disable GPS *198*
Epoch *92, 95*
External event *19*
Extrapolation *92*

F

Factory settings *9, 126, 136*
Fast RTK *92, 94, 281*
FAST RTK mode *118*
Fast RTK Output mode *180*
FEC *82*
Field bag *2*
Field delimiter *143*
Field terminal *33*
FIL,CUR *300*
FIL,D *194*
FIL,DEL *195*

FIL,LST *301*
Firmware options *21, 218, 333*
Firmware update *9*
Firmware upgrade *123*
Firmware version *13, 379*
FIXED *10*
Fixed (solution) *40*
FKP *18, 19, 86, 182*
FLOAT *10*
Float mode *179*
FLS *302*
Forward Correction Error *82*
Frequency band (UHF radio) *82*
FSK *82*

G

GAL *196, 303*
GALILEO *40*
Galileo (enable/disable) *196*
GALILEO satellites status *363*
GALILEO tracking status *303*
General Status screen *10, 37*
Geographic coordinates *69*
Geoid *70, 77*
Geoid model *305*
Georeferencing (image) *133*
G-file being recorded *300*
GGA *210, 304*
GLL *210, 305*
GLO *197, 307*
GLONASS *1, 17*
GLONASS biases *153, 261*
GLONASS carrier phase biases *231*
GLONASS satellites status *364*
GLONASS tracking *197*
GMSK *82*
GNS *307*
GNSS *40*
GNSS centric *18*
GNSS Fix Data *307*
GNSS reception *138*
GNSS tracking configuration *174, 277*
Golden receiver *153*
GPRS *33, 80*
GPS *17, 198, 309*
GPS (enable/disable) *198*
GPS & SBAS satellites status *366*
GPS tracking status *309*
Ground speed *380*
GRS *210, 311*
GSA *210*
GSM *79, 83, 84*

GSM antenna 3, 7, 33
GSM module (built-in) 33
GSM status 11
GST 210, 314
GSV 210, 316

H

Handshaking 186, 288
Header 143
Height mark 9
Helmert 77
HI measurement tape 2, 9
Hopping (frequency hopping) 82
Host cable (USB) 2

I

IGS antenna source table 158
Image database 132
Implementation rules 41, 47
INI 200
Initialization (strategies for) 57
Initializer bar 57
Initializing 56
Inosphere model 384
Insert wait times while a command file is executed 177
Instant RTK 18
Integer ambiguity 56
Internal radio 137
Internal radio (power off) 234
Internal radio (power on) 234
ION 228, 383
IP address 128
ITRF00 70

J

Jamming 108
JGW 131

K

Key combinations 9, 118
Kinematic survey (PP) 51
Kinematic vs. Static 56
Klobuchar 384
Known point 57

L

L1 phase center 8
L2 phase center 8
LAN 129
Latency 92, 93, 94
LCS 122, 201, 317
LED indicators on U-Link TRx 24
LED status (battery charger) 17
Li-ion battery 2
Line of sight 107

Lines 44, 51
Listing files stored in receiver memory or USB key 301
Listing log files 320
Load Config? 120
Local antenna 265
Local coordinate system 122, 317
Local grid 75
Local time 203
Localization 75
LOG 319
Log button 6
Log data for troubleshooting 114
Log file settings 320
Log interval 46, 52
LOG,DEL 202
LOG,LST 320
LOG,PAR 203, 320
Logging points (RTK) 43
Logging points in continuous mode (RTK) 44
Long-range radio link 30
Low battery alarm 226
LRK 18
LTZ 203

M

M memory 136
MAC 18, 19, 86
Magnetic table 380
Mask angle 222
Masks 248, 250, 251, 252, 254
Max. number of observations used in PVT 256
MCA 193
MDM 321
MDM,INI 204
MDM,LVL 323
MDM,OFF 205
MDM,ON 205
MDM,PAR 206
MDM,STS 323
MDP 207, 324
MEM 208, 325
Memory 19
Memory device 325
Memory device used 208
Memory Full 106
Memory screens 12
Modem 80, 83, 136, 321
Modem (initialize) 204
Modem (internal) 128

Modem (power off) 205
Modem (power on) 205
Modem parameters 206
Modem signal level 323
Modem status 323
Modem timeout 209, 325
Modulation type 82
Mount point (connection to) 215
MPC 193, 228, 385
Multipath mitigation 18
MWD 209, 325

N

NAK 144
NAT 129
NATO standard mean seal level 305
NAV 248
Navigation data mask 371
Navigation data masks 251
Network 128
Networks 18
NME 209
NME,ALL 211
NME,PER 212
NMEA 0183 18
NMEA messages 326
NMEA messages (common output rate) 212
NMEA messages (computed) 137
NMEA, NMEA-like messages 209, 211
NMO 326
NPT 213, 327
NTR 328
NTR,LOD 214
NTR,MTP 215, 329
NTR,PAR 216
NTR,TBL 330
NTRIP 79, 84, 86
NTRIP caster 80
NTRIP caster source table 214
NTRIP mount point 329
NTRIP settings 216, 328
Number of re-dials 85

O

Observable 89
Observation time 46, 57, 61
OCC 217, 332
Occupation 217, 332
Occupation time 41, 46
OLED 5
One-point azimuth 77
OPTION 218, 333
Options 124

OTF 57
Output rate 18

P

Pac Crest transmitter 3
PacCrest transmitter (connection diagram) 32
Pages (of information) 6
PAR 334
PAR file 219, 220
PAR,LOD 219
PAR,SAV 220
PBN 390
PEM 222, 336
Phase center 63
Phase center offset 63
PIN code 206
Pinouts 25
Place World Image 133
Plane similarity 76
POP 222, 337
Port A 207
Port A settings 324
Port number 129
POS 211
Position averaging 41
Position computation 138
Position computation screen 13
Post-processed surveying 39
Power (transmitted) 82
Power button 5
Power LED 5
Power management 226
Power on 103
Power settings 140
Power status 11, 342
Power-on screen 9
PPS 224, 339
PPS (1 PPS) 19
PPS time tag 341
Primary RTK 182
PRT 225
Pseudo-range error statistics 314
PTT 211, 341
PWR 342
PWR,OFF 226
PWR,PAR 226

Q

Query commands 143

R

Radio 79, 81
Radio (license-free) 81

- Radio antenna 7, 33, 107
- Radio channel settings 346
- Radio data rate 82
- Radio module 7, 33, 106, 119, 126
- Radio modules 20
- Radio parameters 348
- Radio range 108
- Radio receiver kit 3
- Radio settings 235
- Radio transmitter (#800986) 30
- Radio type 239, 351
- Radius (antenna radius) 63
- Range pole 33
- RAW 227, 343
- Raw data 6, 46
- Raw data icon 10
- Raw data logging 138
- Raw data logging settings 343
- Raw data messages 227
- Raw data output rate 230
- Raw data output settings 360
- Raw data recording 240
- Raw data recording rate 47, 190, 295
- Raw data recording status 353
- RAW,ALL 229
- RAW,PER 230
- RCP,DEL 232
- RCP,GBx 231
- RCP,OWN 345
- RCP,REF 233, 345
- RDP,CHT 346
- RDP,LVL 348
- RDP,OFF 234
- RDP,ON 234
- RDP,PAR 235, 348
- RDP,TYP 239, 351
- Reading current setting for VRS assumption 286
- Reading GLONASS bias setting 261
- Reading RTC Bridge settings 276
- Reading the internal update rate 337
- Reading the radio reception level 348
- Reading the receiver name 345
- Reading the reference receiver name 345
- REC 240, 353
- Receiver configuration (upload/save) 119
- Receiver dynamics 299
- Receiver identification 353
- Receiver identification screen 13
- Receiver initialization 200
- Receiver name 232
- Receiver parameters 334
- Receiver serial number 13
- Recording interval 19
- Reference receiver name 233
- Relative positioning 54
- Relative, centimeter-accurate positioning 54
- Relaying device 87, 127
- Repeater 3, 25
- Reset Procedure 119
- Reset receiver memory 200
- Reset receiver parameters 243
- Reset RTK 184
- Residual error 356
- Rigid body 77
- RMC 210
- rms 74
- RNX,MSI 356
- RNX,TYP 242
- Rover-only configuration 41
- RRE 356
- RS232 from/to RS422 125
- RS232/RS422 207
- RS422 from/to RS232 125
- RST 243
- RT2 193
- RT3 193
- RTC 357
- RTC Bridge 169
- RTC,MSG 244
- RTC,MSI 359
- RTC,TYP 245
- RTCM 18, 90
- RTCM message status 359
- RTCM message type 245
- RTCM messages 1021-1023 122
- RTCM status 357
- RTCM2.3 167
- RTCM3.0-3.1 167
- RTDS Software 87, 127
- RTDS Software (configuration) 128
- RTK correction data 41, 89
- RTK network 282
- RTK output rate 97
- RTK position output modes 91
- RTK real-time surveying 39
- RTK vs. Post-Processing 56
- Run a series of commands 176
- Run commands from USB key 146
- RWO 360

S

- SAG 228, 393

- SAL 228, 392
- SAT 211
- Satellite use mask 374
- Satellites in use 10
- Save Image Boundary 133
- Save receiver configuration to USB key 122
- Saving the receiver configuration to a PAR file 220
- SAW 228, 395
- SBA 247, 362
- SBA,DAT message 229
- SBAS 1, 18, 40
- SBAS differential position solution (tagging) 327
- SBAS differential positions in NME/NMEA-like messages (tagging) 213
- SBAS tracking 247
- SBAS tracking status 362
- SBD 228
- SBN 228
- Scenario 242, 356
- Scrambling 83
- Screen backlight 15
- Script 146
- Scroll button 5, 6, 9
- Select Image Database 133
- Semi-major axis 314
- Semi-minor axis 314
- Send Command 145
- Send File 145
- Serial commands 143, 147
- Serial port 8
- Serial Ports 136
- Server connection 187
- Set commands 143
- Set date & time 260
- Set internal update rate for measurements and PVT 222
- Setting the log file 203
- Setup (PP base) 36
- Setup (PP rover) 36
- SGA 363
- SGL 364
- SGP 366
- SHMP 63, 159
- SHMP offset 63
- Signal observation masks 248
- Signal Observations Masking 370
- Signal to noise ratio mask 248
- Signal-to-Noise ratio 369
- Signal-to-noise ratio mask 372
- Signal-to-noise ratio masks 252

- SIM card 33, 125
- Single vs. multi-frequency 57
- SIT 247, 368
- Site name 247, 368
- Size 19
- Slant height measurement 64
- Slant measurement 9, 154
- SNG 228, 397
- SNM 248, 369
- SNR 248
- SNV 228, 399
- SNW 228, 401
- SOM 248, 370
- SOM,CTT 250, 370
- SOM,NAV 251, 371
- SOM,SNR 252, 372
- SOM,SVM 374
- SOM,WRN 254, 373
- Source table 80, 330
- Staking out (RTK) 45
- Standalone (raw data logging) 36
- Static IP address 128, 129
- Static survey (PP) 48
- Station ID 255, 374
- Status (position) 10
- STI 255, 374
- Stop & Go survey (PP) 49
- SVM 256
- Synchronization with GPS time 258, 376

T

- TCP/IP Direct 80
- TDMA 80, 84
- TFW 131
- Time & date 381
- Time mode 52
- Time out 85
- Time-tagged RTK 92, 93
- Time-tagged RTK mode 118
- Too few satellites 104
- Trajectories 44, 51
- Transfer rate 80
- Tribrach 30
- Tripod 30
- TTF 41, 57, 60
- Turning receiver on 226

U

- U memory 136
- UDP 257, 375
- UDP/IP Direct 80
- U-Link 30
- U-Link receiver modules (U-link Rx) 3

- U-Link Rx specifications *23*
- U-Link transmitter *31*
- U-Link TRx *3*
- U-link TRx *3*
- U-Link TRx specifications *22*
- U-Link TRx Y-shaped cable description and pinout *25*
- UNT *257, 376*
- Upgrade procedure (firmware) *123*
- Upload receiver configuration from USB key *120*
- Upload Script? *114, 120, 146, 147*
- USB port *8*
- USB status *11*
- Use Image Database *133*
- User message *244*
- User-defined antenna (delete) *155*
- User-defined dynamic model *257, 375*
- UTC *203*
- UTS *258*

V

- VEC *211, 377*
- Vector components *377*
- VERSION *379*
- Vertical height measurement *65*
- Vertical measurement *154*
- Virtual antenna *67, 265*
- Virtual antenna (specify name) *156*
- VRS *18, 19, 86*
- VRS assumption mode *185*
- VTG *210, 380*

W

- WAK *259*
- WARN *381*
- Warning messages *381*
- Weight *19*
- WGS84 *70*
- WinComm *144*
- WMM-2005 World Magnetic Model *380*
- World file editor *131*
- WRN *249*

Z

- Z-BLADE *18, 40*
- ZDA *210, 260, 381*



DECLARATION DE CONFORMITE CE
 DECLARATION OF CONFORMITY
 DIRECTIVE R&TTE 1999/5/CE .
 (EMC Directive 2004/108/EC and
 LVD directive 2006/95/EC included)

FABRICANT : Société ASHTECH S.A.S.
 MANUFACTURER : ASHTECH S.A.S.
 ADRESSE : Z.A.C. de la Fleuriaye
 ADDRESS : B.P. 60433
 44474 CARQUEFOU CEDEX

déclare que les produits :
 (certifies that the product mentioned below)

NOM DU PRODUIT (PRODUCT NAME) ProMark 800 series with GSM, BlueTooth, UHF options - COM-
 MOD ULINK 410-470 ,RXO-ADL UHF 390-430MHz , on internal Battery

SYMBOLE (SYMBOL NUMBER) : P/N990657 -xx, P/N 802147 -x, etc...

satisfont aux exigences essentielles pour le marquage CE , conformément à la DIRECTIVE R&TTE
 1999/5/CE: (will meet the test listed below, as requires by the DIRECTIVE R&TTE 1999/5/CE)

- normes (Standard) ETSI EN 300 328, EN 300 440, EN 300 113-2, EN 301 511-2 , Radio
 spécifications

- normes (Standard) ETSI EN 301 489- 1, -3 , -5, -7 , -17; EMC spécifications ;
 IEC 61000-4-2 :2009 , ; IEC 61000-4-3 :2006 +A1.

- LVD directive 2006/95/EC ; EN 60950-1 Safety spécifications

normes (Standard) FCC : 47 CFR Part 15 Class B , Subparts B & C.

normes (Standard) RSS GEN ; IC RSS 210 , RSS-102 ; ICES-003 Ed. 4

Information complémentaire (Information supplement) : Gyl Technologies

..Date de certification : April 2008 & Oct 2011.
 (Date of Certification tests)

NOM DU SIGNATAIRE (BY)
 LIEU (PLACE) :
 TITRE DU SIGNATAIRE (TITLE)

DATE (DATE): OCT , 4TH 2011

ASHTECH S.A.S.

Capital social de 7 125 227 euros ; RCS Nantes 321 391 227
 B.P.60433 44474 CARQUEFOU CEDEX (FRANCE)
 Tel : +33 (0)2 28 09 38 00 FAX : +33 (0)2 28 09 39 39

: Responsable Qualité Produits
 (Product Quality Manager)
 SIGNATURE (SIGNATURE):

Reference Manual

Contact Information:

Spectra Precision Division
10355 Westmoor Drive,
Suite #100
Westminster, CO 80021, USA
www.spectraprecision.com

Ashtech S.A.S.
Rue Thomas Edison
ZAC de la Fleuriaye, BP 60433
44474 Carquefou Cedex, FRANCE
www.ashtech.com

